

# Surge protection devices Catalogue 2014/2015

Let's connect.

Surge protection





## Dear Customers,

The PDF versions of our catalogues offer practical additional functions, helping you to find your way around our product range and simplifying the ordering process.

In addition to the catalogue, the PDF also contains:

- Internal page links
- Links to the online catalogue

Try it out for yourself. Click the order number to obtain more detailed information and close-up images via your web browser. The links in the PDF file also enable you to go directly to the next desired catalogue page.

Further Weidmüller product catalogues can be accessed by clicking the following:





# Surge Protection Devices Catalogue 4.4

## Surge Protection Devices



A brief introduction to surge protection



Lightning and surge protection for control and instrumentation signals



Lightning and surge protection for low voltage facilities



Lightning and surge protection for data interfaces



Mains filter



Surge protection for photovoltaic systems

A

B

C

D

E

F

## Appendix



The basics of lightning and surge protection

Index

Search according to Type or order number,  
Addresses worldwide

W

X

# Lightning and surge protection for control and instrumentation signals

## VARITECTOR SPC

Page B.16



Pluggable surge protection for C&I circuits (IEC 61643-21)

## VARITECTOR SSC 6AN

Page B.70



2-stage surge protection with 6 screw connection for C&I circuits (IEC 61643-21)

## VARITECTOR SSC 4AN

Page B.94



Pluggable surge protection for C&I circuits (IEC 61643-21)

## MCZ OVP series

Page B.110

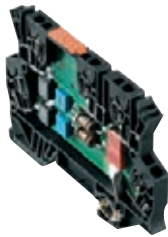

3-stage lightning and surge protection for measurement and control systems, with tension-clamp connection

## RS series

Page B.122



Three-stage surge protection for analogue signals with high current requirement, or for power supplies in instrumentation and control systems

## VARITECTOR SPC EX

Page B.146



Plug-in lightning and surge protection for intrinsically safe circuits in gas and dust atmospheres up to Zone 0

## VARITECTOR SSC EX

Page B.162



2-stage lightning and surge protection with screw connections: for intrinsically safe circuits in gas and dust atmospheres up to Zone 0

# Lightning and surge protection for low voltage facilities

## VPU I 50 kA / 35 kA series

Page C.14



Type I/II lightning and surge protection for the LPL I, II, III, IV for installation before the electrical meter

## VPU I 25 kA series

Page C.16



Type I/II lightning and surge protection for the LPL I, II, III, IV for installation before the electrical meter

## VPU I N-PE series

Page C.23



Type I/II N-PE lightning and surge protection for LPL I, II, III, IV for installation before the electrical meter

## VPU I 12.5 kA series

Page C.25



Type I lightning and surge protection for LPL III, IV for installation before/downstream of the electrical meter

## PU I TSG+I 50kA; 330 V and 440 V

Page C.35



Type I lightning and surge protection for LPL I, II, III, IV for installation before the electrical meter

## VPU II series

Page C.38



Type II/III surge protection for installation in main and sub-distributions in various nominal voltages

## VPU I and II photovoltaics

Page C.59



Type I and type II/III lightning and surge protection for installation in DC photovoltaic applications

## VPU III series

Page C.68



Type III surge protection for installation close to the device requiring protection

# Lightning and surge protection for data interfaces

## VARITECTOR SPC

Page D.4



Plug-in lightning and surge protection certified according to IEC 61643-21: for data ports (e.g. RS485) or high frequency (HF) signals

## VARITECTOR SSC 6AN

Page D.14



2-stage lightning and surge protector with six screw connections: for data ports (e.g. RS485 and RS232)

## RS485/422

Page D.16



Surge protection for RS485 data interface, in protected housing with T-junction option and optional earth connection via gas discharge tube

## LON™

Page D.17



Bus termination terminal for LON™ Termination LPT/FTT/TP 78, with screw connection

## JPOVP CAT.6

Page D.19



Protection for Class-III end devices in IP 20 and IP 67 versions for use in Ethernet Cat. 6 circuits

## COAX

Page D.22



Surge protection for COAX interfaces, as BNC, N, F, and UHF adapter plug

## TAE surge protection

Page D.27



Surge protection for TAE telecommunication ports with analogue and ISDN signals

# Mains filter

## Wavefilter

Page E.4



Mains filter, 3/6/10 A, with screw connection for 230 V devices or voltage supplies

# Surge protection for photovoltaic systems

## Photovoltaic

Chapter F





# A brief introduction to surge protection

---

<b>A brief introduction to surge protection</b>	Is surge protection worthwhile?	A.2
---	---------------------------------	-----

---



# Is surge protection worthwhile?

A



## You can rely on luck or take precautions

The priority you give to surge protection depends on your willingness to take risks! Perhaps you think "it'll never happen to me". You won't have lost anything, but you will also have gained little, if nothing at all, and you run the risk of a surge overvoltage at any time.

However, if you wish to be on the safe side, simply make sure you include surge protection as part of your corporate strategy. Such an investment will not only assure you of operational reliability but could also vastly limit damage and costs should a disaster strike.

## Disaster from the sky

The violent forces of nature in the form of a thunderstorm are a spectacular show. Potentially, this is a dangerous event for human beings and is no less dangerous when it comes to industrial and commercial premises and equipment. While a person is usually only exposed to a risk of being struck by lightning when it is in his or her immediate vicinity, this is not the case with electrical equipment. Lightning strikes up to 2 km away can damage electrical components.

In addition, electrical systems are considerably more sensitive to the indirect electrical discharge a lightning bolt can produce. Lightning strikes can generate secondary voltages in anything that conducts and can therefore seriously endanger the insulation of electrical equipment.

The number of lightning strikes per annum, in Europe alone, are considerable. Lightning strikes are registered worldwide and you can get the latest figures by visiting [www.wetteronline.de/eurobli.htm](http://www.wetteronline.de/eurobli.htm)

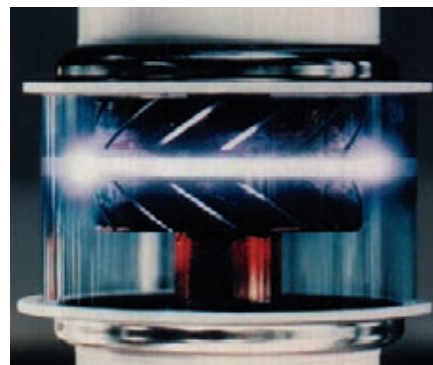

Electric arc in a 10 kV switch while being switched off



### Disaster from inside your premises

Wherever electricity is used, it must also be switched on and off. The physical processes involved in a switching operation cause many surge overvoltages than those from the sky. Added to this are overvoltages caused by electrostatic discharges or faulty switching operations. These overvoltages are nowhere near as high as those of lightning, but as they are generated directly in the lines, they are also directly in the system and place a stress on the insulation.

### Protection would seem to be a matter of common-sense

Our modern working lives would be inconceivable without power supply systems, instrumentation and control equipment, IT networks and much more besides. They have become commonplace and we realise their significance only when they break down. The potential resulting scenarios can range from a brief interruption at work, to bankruptcy. Common sense should surely dictate good protection against lightning or surge voltages.

### Surge protection is a topic for today

Surge protection is an important aspect of electromagnetic compatibility and is required by law. There have been many technical improvements in this field over the years. The quality and quantity of surge protection systems have increased. This is demonstrated by the statistics from the umbrella organisation for the German insurance industry: the annual total damages for the insurance of electronic equipment has fallen slightly, despite the fact that more electronic equipment is almost certainly being used and electrical and electronic systems are becoming increasingly complex, with the degree of integration also increasing.

### Voltages that exceed the limits

Surges are voltages that exceed the normal values. These normal values determine the insulation, which is designed and tested according to the appropriate regulations. The degree of insulation varies depending on the type of electrical equipment. We therefore speak of "insulation co-ordination".

An item for use with 230 V, e.g. an electric motor, is fitted with insulation tested with a few kilovolts. It is obvious that a chip on a PCB operating with 5 V cannot have the same dielectric strength. For this chip 10 V could mean disaster. An analogue converter, relay and opto modules are not surge protection components because they only provide electrical isolation.



Destroyed component

### Surge protection calls for special knowledge

There are different overvoltage protection requirements that need to be identified when undertaking insulation co-ordination. The solution must include the capability to conduct high voltages with high currents, just as safely as small voltages with small currents. Therefore, surge protection is a complex subject. It comprises of not just one electrical component but rather several functional elements combined in one circuit. This calls for special engineering expertise – not just for the provision of functional surge protection modules, but also for their utilisation, planning and installation.

Therefore, this catalogue does not just present our products but instead provides comprehensive information to help you understand the subject of surge protection.

**Chapter W provides an overview of lightning and surge protection.**



# Lightning and surge protection for control and instrumentation signals

<b>Lightning and surge protection for control and instrumentation signals</b>	Quick selection guide	B.2
	Certification	B.5
	Lightning and surge protection for control and instrumentation signals	B.6
	VARITECTOR SPC - Overview	B.8
	VARITECTOR SPC	B.14
	V-TEST	B.60
	VARITECTOR SSC - Overview	B.63
	VARITECTOR SSC 6AN	B.68
	VARITECTOR SSC 4AN	B.92
	MCZ OVP series	B.106
	RS series	B.122
	Earthing for shielded cables	B.126
	Installation advice for instrumentation and control engineering	B.132
	<b>Lightning and surge protection for measurement and control systems intrinsically safe circuits (Ex zone)</b>	VARITECTOR SPC EX - Overview
VARITECTOR SPC EX		B.144
VARITECTOR SSC EX - Overview		B.159
VARITECTOR SSC EX		B.160
ATEX and IEC Ex approvals		B.174



# Product quick selection for measurement and control signals

## Instrumentation and control equipment

Interface/ signal	Mounting	Connection system	Protected wires	Discharge	Operating	max.	Protection device	Order No. Arrestor	Order No. Direct earthing base	Order No. Indirect earthing base
				capacity	current	voltage				
				8/20 $\mu$ s	I <sub>max.</sub>	DC				
O(4) ... 20 mA	on DIN rail, separable	Screw terminals	4	5 kA	0.45 A	28 V	VSPC 2CL 24 V DC 0.5 A	8924470000	8924710000	8924270000
O(4) ... 20 mA	on DIN rail, separable	Screw terminals	2	5 kA	0.45 A	28 V	VSPC 1CL 24 V DC 0.5 A	8924480000	8924730000	8924290000
O...10 V	on DIN rail, separable	Screw terminals	4	5 kA	0.45 A	28 V	VSPC 2CL 24 V DC 0.5 A	8924470000	8924710000	8924270000
O...10 V	on DIN rail, separable	Screw terminals	2	5 kA	0.45 A	28 V	VSPC 1CL 24 V DC 0.5 A	8924480000	8924730000	8924290000
0-20 mA, 4-20 mA	on DIN rail, compact	Tension clamp terminals	2	5 kA	0.5 A - 1.25 A	28 V	MCZ OVP 1CL 24 V 0.5 A	8448920000 8449080000		
VSSC and VSPC for binary signals	on DIN rail, compact	Screw terminals	2	5 kA	0.5 A					
Hart	on DIN rail, separable	Screw terminals	2	5 kA	0.45 A	28 V	VSPC 1CL 24 V DC 0.5 A	8924480000	8924730000	8924290000
Cathodic corrosion protection	on DIN rail, separable	Screw terminals	2	5 kA	2 A	72 V	VSPC GDT 2 CH 90 V 20 kA	8924570000	8924740000	8924300000
PT 100, PT 1000	on DIN rail, compact	Tension clamp terminals	2	5 kA	1.25 A	24 V	MCZ OVP SL 24 V 1.25 A	8448970000		
PT 100	on DIN rail, binary	Screw terminals	4	5 kA	0.45 A	24 V	VSPC 3/4WIRE 24 V DC	8924550000	8924740000	8924300000
RS232	on DIN rail, compact	Tension clamp terminals	2	5 kA	0.5 A	24 V	MCZ OVP SL 24 V 0.5 A	8448940000		
RS422,V11	on DIN rail, compact	Tension clamp terminals	2	5 kA	0.5 A	24 V	MCZ OVP SL 24 V 0.5 A	8448940000		
RS422A, V.11, X.27, RS423A	on DIN rail, separable	Screw terminals	4	5 kA	0.45 A	15 V	VSPC 2CL HF 12 V DC	8924460000	8924710000	8924270000
RS449	on DIN rail, separable	Screw terminals	4	5 kA	0.45 A	15 V	VSPC 2CL HF 12 V DC	8924460000	8924710000	8924270000
RS485	on DIN rail, compact	Tension clamp terminals	2	5 kA	0.5 A	24 V	MCZ OVP SL 24 V 0.5 A	8448940000		
RS485	built-in housing	Screw terminals	4	0.5 kA		12 V	RS485/RS422 K21	8008501001		
RS485	on DIN rail, separable	Screw terminals	4	5 kA	0.45 A	6.4 V	VSPC R485 2 CH	8924670000	8924710000	8924270000
RS232-C / V.24	on DIN rail, separable	Screw terminals	4	5 kA	0.45 A	15 V	VSPC 2CL HF 12 V DC	8924460000	8924710000	8924270000
TTL	on DIN rail, compact	Tension clamp terminals	2	5 kA	0.5 A	24 V	MCZ OVP SL 24 V 0.5 A	8448940000		
TTY	on DIN rail, compact	Tension clamp terminals	2	5 kA	0.5 A	24 V	MCZ OVP SL 24 V 0.5 A	8448940000		

## Bus systems

Interface/ signal	Mounting	Connection system	Protected wires	Discharge	Operating	max.	Protection device	Order No. Arrestor	Order No. Direct earthing base	Order No. Indirect earthing base
				capacity	current	voltage				
				8/20 $\mu$ s	I <sub>max.</sub>	DC				
ARCNET (Plus)	on DIN rail	Screw terminals	2	2 kA	16 A	-	PU III R 48 V	8860350000		
ASI	on DIN rail	Screw terminals	2	2 kA	16 A	-	PU III R 24 V	8860360000		
ASI	on DIN rail, separable	Screw terminals	4	5 kA	0.45 A	15 V	VSPC 2CL HF 12 V DC	8924460000	8924710000	8924270000
BITBUS	on DIN rail, separable	Screw terminals	4	5 kA	0.45 A	15 V	VSPC 2CL HF 12 V DC	8924460000	8924710000	8924270000
BLN (Building Level Network)	on DIN rail, separable	Screw terminals	2	5 kA	0.45 A	28 V	VSPC 1CL 24 V DC 0.5 A	8924480000	8924730000	8924290000
BLN (Building Level Network)	on DIN rail, separable	Screw terminals	4	5 kA	0.45 A	28 V	VSPC 2CL HF 12 V DC	8924460000	8924710000	8924270000
CAN-Bus	on DIN rail, separable	Screw terminals	4	5 kA	0.45 A	15 V	VSPC 2CL HF 12 V DC	8924460000	8924710000	8924270000
CANopen	on DIN rail, compact	Tension clamp terminals	2	5 kA	0.3 A	12 V	MCZ OVP HF 12 V 0.3 A	8948610000		
C-BUS	on DIN rail, separable	Screw terminals	4	5 kA	0.45 A	15 V	VSPC 2CL HF 12 V DC	8924460000	8924710000	8924270000
C-Bus (Honeywell)	on DIN rail, compact	Tension clamp terminals	2	5 kA	0.3 A	5 V	MCZ OVP HF 5 V 0.3 A	8948620000		
CC-LINK	on DIN rail, separable	Screw terminals	4	5 kA	0.45 A	15 V	VSPC 2CL HF 12 V DC	8924460000	8924710000	8924270000
Data Highway (Plus), DH+	on DIN rail, separable	Screw terminals	4	5 kA	0.45 A	15 V	VSPC 2CL HF 12 V DC	8924460000	8924710000	8924270000
DATEx P	on DIN rail, compact	Tension clamp terminals	2	5 kA	0.3 A	24 V	MCZ OVP HF 24 V 0.3 A	8948600000		
Device Net	on DIN rail, compact	Tension clamp terminals	2	5 kA	0.3 A	12 V	MCZ OVP HF 12 V 0.3 A	8948610000		
DeviceNet	on DIN rail, separable	Screw terminals	4	5 kA	0.45 A	15 V	VSPC 2CL HF 12 V DC	8924460000	8924710000	8924270000
DIN measurement bus	on DIN rail, separable	Screw terminals	2	5 kA	0.45 A	15 V	VSPC 1CL 12 V DC 0.5 A	8924450000	8924730000	8924290000
Dupline / Miniplex	on DIN rail, separable	Screw terminals	2	5 kA	0.45 A	28 V	VSPC 1CL 24 V DC 0.5 A	8924480000	8924730000	8924290000

## Bus systems

Interface/ signal	Mounting	Connection system	Protected wires	Discharge	Operating	max. voltage	Protection device	Order No. Arrestor	Order No. Direct earthing base	Order No. Indirect earthing base
				capacity	current					
E1	on DIN rail, separable	Screw terminals	4	5 kA	0.45 A	6.4 V	VSPC 2CL HF 5 V DC	8924430000	8924710000	8924270000
EIB (European Installation Bus)	on DIN rail, separable	Screw terminals	2	5 kA	0.45 A	28 V	VSPC 1CL 24 V DC 0.5 A	8924480000	8924730000	8924290000
ET 200	on DIN rail, separable	Screw terminals	2	5 kA	0.45 A	28 V	VSPC 1CL 5 V DC 0.5 A	8924420000	8924730000	8924290000
ET 200	on DIN rail, compact	Tension clamp terminals	2	5 kA	0.3 A	5 V	MCZ OVP HF 5 V 0.3 A	8948620000		
Ethernet Cat.6	Plug-in adapter	RJ 45 connection	4	10 kA	1 A	48 V	V DATA Cat.6	1348590000		
Ethernet Cat.5	Adapter plug	M12	4	10 kA		30 V	JACKPAC® Ethernet Cat.5 M12	8805570000		
Ethernet Cat.6	Adapter plug	RJ 45 connection	4	10 kA		48 V	JACKPAC® Ethernet Cat.6 IP20	8805550000		
Ethernet Cat.6	Adapter plug	RJ 45 connection	4	10 kA		48 V	JACKPAC® Ethernet Cat.6 IP67	8805560000		
FIPIO / FIPWAY	on DIN rail, separable	Screw terminals	4	5 kA	0.45 A	6.4 V	VSPC 2CL HF 5 V DC	8924430000	8924710000	8924270000
Genius I/O Bus	on DIN rail, separable	Screw terminals	4	5 kA	0.45 A	15 V	VSPC 2CL 12 V DC 0.5 A	8924440000	8924710000	8924270000
HDSL	on DIN rail, compact	Tension clamp terminals	2	5 kA	0.3 A	24 V	MCZ OVP HF 24 V 0.3 A	8948600000		
IEC-BUS	on DIN rail, separable	Screw terminals	4	5 kA	0.45 A	6.4 V	VSPC 2CL HF 5 V DC	8924430000	8924710000	8924270000
Interbus	on DIN rail, compact	Tension clamp terminals	2	5 kA	0.3 A	5 V	MCZ OVP HF 5 V 0.3 A	8948620000		
Interbus-Inline I/O	on DIN rail, compact	Tension clamp terminals	2	10 kA	1.25 A	53 V	MCZ OVP CL 48 V 1.25 A	8449040000		
LON™ (Works)	on DIN rail, separable	Screw terminals	4	5 kA	0.45 A	85 V	VSPC 1CL 48 V AC 0.5 A	8924520000	8924730000	8924290000
LON™ TP/XF 78	on DIN rail, compact	Tension clamp terminals	2	10 kA	0.5 A	28 V	MCZ OVP CL 24 V 0.5 A	8448920000		
LON™ TP/XF 78	on DIN rail, compact	Tension clamp terminals	2	0,1 kA	16 A	14 V	MCZ OVP LON Bus	8473470000		
LON™-Bus	on DIN rail, compact	Tension clamp terminals	2	5 kA	0.3 A	12 V	MCZ OVP HF 12 V 0.3 A	8948610000		
LRE networks	on DIN rail, separable	Screw terminals	4	5 kA	0.45 A	6.4 V	VSPC 2CL HF 5 V DC	8924430000	8924710000	8924270000
LUXMATE-Bus	on DIN rail, separable	Screw terminals	4	5 kA	0.45 A	28 V	VSPC 2CL HF 24 V DC	8924510000	8924710000	8924270000
M-Bus	on DIN rail, compact	Tension clamp terminals	2	5 kA	0.3 A	24 V	MCZ OVP HF 24 V 0.3 A	8948600000		
M-Bus (remote reading of meter)	on DIN rail, separable	Screw terminals	2	5 kA	0.45 A	28 V	VSPC 1CL 24 V AC 0.5 A	8924500000	8924730000	8924290000
MOD-Bus	on DIN rail, compact	Tension clamp terminals	2	5 kA	0.3 A	5 V	MCZ OVP HF 5 V 0.3 A	8948620000		
MODBUS(-PLUS)	on DIN rail, separable	Screw terminals	4	5 kA	0.45 A	15 V	VSPC 2CL HF 12 V DC	8924460000	8924710000	8924270000
MPI Bus	on DIN rail, separable	Screw terminals	4	5 kA	0.45 A	6.4 V	VSPC R485 2 CH	8924670000	8924710000	8924270000
N1 LAN	on DIN rail, separable	Screw terminals	4	5 kA	0.45 A	6.4 V	VSPC 2CL HF 5 V DC	8924430000	8924710000	8924270000
N2 Bus	on DIN rail, separable	Screw terminals	2	5 kA	0.45 A	6.4 V	VSPC 2SL 5 V DC 0.5 A	8924210000	8924720000	8924280000
(P-Bus)	on DIN rail, compact	Screw terminals	2	2 kA	16 A	-	PU III R 24 V	8860360000		
P-NET	on DIN rail, separable	Screw terminals	4	5 kA	0.45 A	15 V	VSPC 2CL HF 12 V DC	8924460000	8924710000	8924270000
Procontic CS31	on DIN rail, separable	Screw terminals	2	5 kA	0.45 A	15 V	VSPC 1CL 12 V DC 0.5 A	8924450000	8924730000	8924290000
Procontic CS31	on DIN rail, separable	Screw terminals	4	5 kA	0.45 A	15 V	VSPC 2CL HF 12 V DC	8924460000	8924710000	8924270000
Procontic T200	on DIN rail, separable	Screw terminals	4	5 kA	0.45 A	15 V	VSPC 2CL HF 12 V DC	8924460000	8924710000	8924270000
Profibus	on DIN rail, compact	Tension clamp terminals	2	5 kA	0.3 A	5 V	MCZ OVP HF 5 V 0.3 A	8948620000		
(Profibus DP)	on DIN rail, separable	Screw terminals	4	5 kA	0.45 A	6.4 V	VSPC R485 2 CH	8924670000	8924710000	8924270000
Profibus DP (FMS)	on DIN rail, separable	Screw terminals	4	5 kA	0.45 A	6.4 V	VSPC 2CL HF 5 V DC	8924430000	8924710000	8924270000
Profibus DP (FMS)	on DIN rail, separable	Screw terminals	4	5 kA	0.45 A	15 V	VSPC 2CL HF 12 V DC	8924460000	8924710000	8924270000
Profibus DP/FMS	on DIN rail, separable	Screw terminals	2	6 kA	1.5 A	12 V	RS485	9454930000+8007871001		
Profibus PA	on DIN rail, compact	Tension clamp terminals	2	10 kA	1.25 A	53 V	MCZ OVP CL 48 V 1.25 A	8449040000		
Profinet	on DIN rail, compact	Tension clamp terminals	2	5 kA	0.3 A	5 V	MCZ OVP HF 5 V 0.3 A	8948620000		
Process Bus, Panel Bus	on DIN rail, separable	Screw terminals	4	5 kA	0.45 A	15 V	VSPC 2CL HF 12 V DC	8924460000	8924710000	8924270000
PSM-EG-RS422...	on DIN rail, separable	Screw terminals	4	5 kA	0.45 A	15 V	VSPC 2CL HF 12 V DC	8924460000	8924710000	8924270000
PSM-EG-RS485...	on DIN rail, separable	Screw terminals	4	5 kA	0.45 A	15 V	VSPC 2CL HF 12 V DC	8924460000	8924710000	8924270000
RACKBUS	on DIN rail, separable	Screw terminals	4	5 kA	0.45 A	6.4 V	VSPC 2CL HF 5 V DC	8924430000	8924710000	8924270000
SDLC	on DIN rail, separable	Screw terminals	4	5 kA	0.45 A	15 V	VSPC 2CL HF 12 V DC	8924460000	8924710000	8924270000
SDSL	on DIN rail, separable	Screw terminals	4	5 kA	0.45 A	185 V	VSPC Uko	8924660000	8924710000	8924270000
SecuriLan-LON™-Bus	on DIN rail, separable	Screw terminals	2	5 kA	0.45 A	15 V	VSPC 1CL 12 V DC 0.5 A	8924450000	8924730000	8924290000
SINEC L1	on DIN rail, separable	Screw terminals	4	5 kA	0.45 A	6.4 V	VSPC 2CL HF 5 V DC	8924430000	8924710000	8924270000
Sinec L2	on DIN rail, compact	Tension clamp terminals	2	5 kA	0.3 A	5 V	MCZ OVP HF 5 V 0.3 A	8948620000		
SINEC L2 DP	on DIN rail, separable	Screw terminals	4	5 kA	0.45 A	6.4 V	VSPC 2CL HF 5 V DC	8924430000	8924710000	8924270000
Sinec L2 DP/ -Profibus DP	on DIN rail, separable	Screw terminals	2	6 kA	1.5 A	12 V	RS485	9454930000+8007871001		
TCP / IP	on DIN rail, compact	Tension clamp terminals	2	5 kA	0.3 A	5 V	MCZ OVP HF 5 V 0.3 A	8948620000		
Token Ring	on DIN rail, compact	Tension clamp terminals	2	0.5 kA	16 A	27 V	MCZ OVP TAZ 24 V	8449160000		
Token Ring	on DIN rail, compact	Tension clamp terminals	2	5 kA	0.3 A	5 V	MCZ OVP HF 5 V 0.3 A	8948620000		
TP/FTT 10+TP/LPT10	on DIN rail, compact	Tension clamp terminals	2	10 kA	1.25 A	53 V	MCZ OVP CL 48 V 1.25 A	8449040000		
U-BUS	on DIN rail, separable	Screw terminals	4	5 kA	2 A	72 V	VSPC GDT 2 CH 90 V 20 kA	8924570000	8924740000	8924300000

# Product quick selection, information technology

## Telecommunications

Interface/ signal	Mounting	Connection system	Protected wires	Discharge	Operating	max.	Protection device	Order No. Arrestor	Order No. Direct earthing base	Order No. Indirect earthing base
				capacity	current	voltage				
				8/20 $\mu$ s	I <sub>max.</sub>	DC				
ADSL	on DIN rail, separable	Screw terminals	4	5 kA	0.45 A	185 V	VSPC Uko	8924660000	8924710000	8924270000
ADVANT	on DIN rail, separable	Screw terminals	4	5 kA	0.45 A	6.4 V	VSPC 2CL HF 5 V DC	8924430000	8924710000	8924270000
HDSL	on DIN rail, separable	Screw terminals	4	5 kA	0.45 A	185 V	VSPC Uko	8924660000	8924710000	8924270000
SHDSL	on DIN rail, separable	Screw terminals	4	5 kA	0.45 A	185 V	VSPC Uko	8924660000	8924710000	8924270000
T-DSL	on DIN rail, separable	Screw terminals	4	5 kA	0.45 A	185 V	VSPC Uko	8924660000	8924710000	8924270000
Telephone analogue	on DIN rail, separable	Screw terminals	4	5 kA	0.45 A	185 V	VSPC Uko	8924660000	8924710000	8924270000
TTY, 0(4) - 20 mA	on DIN rail, separable	Screw terminals	4	5 kA	0.45 A	28 V	VSPC 2CL 24 V DC 0.5 A	8924470000	8924710000	8924270000
(Uko-Bus)	on DIN rail, separable	Screw terminals	4	5 kA	0.45 A	185 V	VSPC Uko	8924660000	8924710000	8924270000
V.35	on DIN rail, separable	Screw terminals	4	5 kA	0.45 A	6.4 V	VSPC 2CL HF 5 V DC	8924430000	8924710000	8924270000
VDSL	on DIN rail, separable	Screw terminals	4	5 kA	0.45 A	185 V	VSPC Uko	8924660000	8924710000	8924270000
X.21/X.24	on DIN rail, separable	Screw terminals	4	5 kA	0.45 A	15 V	VSPC 2CL HF 12 V DC	8924460000	8924710000	8924270000
X.25/X.31	on DIN rail, separable	Screw terminals	4	5 kA	0.45 A	15 V	VSPC 2CL HF 12 V DC	8924460000	8924710000	8924270000

## Power supply

Interface/ signal	Mounting	Connection system	Protected wires	Discharge	Operating	max.	Protection device	Order No.
				capacity	current	voltage		
				8/20 $\mu$ s	I <sub>max.</sub>	DC		
24V 6A	clip-on base profiles	Screw terminals	2	24 kA	6 A	27 V	RSU 24 V 6 A	1171361001
115V 6A	clip-on base profiles	Screw terminals	2	24 kA	6 A	130 V	RSU 115 V 6 A	1171561001
230V 6A	clip-on base profiles	Screw terminals	2	24 kA	6 A	250 V	RSU 230 V 6 A	1171661001
115V 10A	clip-on base profiles	Screw terminals	2	24 kA	10 A	130 V	RSU 115 V 10 A	8104221001
230V 10A	clip-on base profiles	Screw terminals	2	24 kA	10 A	250 V	RSU 230 V 10 A	8093281001

# SIL certification for VSSC and VSPC



## Zertifikat

Certificate

**Registrier-Nr.**  
Registration No.  
**44 799 11 204001-001**

Zeilchen des Auftraggebers Customer's reference	Auftragdatum Date of order 18.03.2011	Aktivierungs-Nr. File reference 8000394001	Technischer Bericht Nr. Test report no. 11 799 004001-001
Name und Anschrift des Auftraggebers	Weidmüller Interface GmbH & Co. KG Klingenbergstraße 10 32758 Detmold		Kunden-Nr. und -adresse
Geprüft nach	EN 61008-2010 Funktionale Sicherheit sicherheitsbezogener elektrischer/elektronischer/programmierbarer elektronischer Systeme		Tested in accordance with
Bezeichnung des Produktes (Detailliert siehe Anlage 1)	Überspannungsschutz / Overvoltage protection  VARITECTOR SPC und SSC		Description of product (Detailed see Annex 1)
Typenbezeichnung	VARITECTOR SPC und SSC		Type Description
Bemerkung	Die einzelnen Typen der Überspannungsschutzreihe können in SEL2 oder SEL3 Sicherheitskreisläufen eingesetzt werden! The single types of the overvoltage protection series can be used in SEL2 or SEL3 safety circuits. Die sichere Funktion beruht nicht auf den Einsatz in einem Kommunikationssystem! / The safety function is intended for application in a communication system!		Remark

Dieses Zertifikat bescheinigt das Ergebnis der Prüfung an dem vorgelegten Prüfgegenstand. Eine allgemeine Aussage über die Qualität der Produkte aus der technischen Fertigung kann hieraus nicht abgeleitet werden.  
This certifies the result of the examination of the product sample submitted by the manufacturer. A general statement concerning the quality of the products from the series manufacture cannot be derived therefrom.

TUV NORD CERT GmbH  
Zertifizierungsstelle / Certification body  
Magdeburg / Magdeburg



02036 661 / 1400 bis 13.04.2016  
Hannover, 13.04.2011

Bitte beachten Sie auch die sonstigen Hinweise  
Please also pay attention to the information stated therein!  
Lagerstr. 20 • 01141 Eisen - Fax +49 (0)37 528 9120 • Fax +49 (0)37 528 9200 • Email: produkt@tuv-nord.de



### Anlage 1 zum Zertifikat Nr.:

Annex 1 to Certificate No.:

**44 799 11 394001-001**

Rev. 1

Aktivierungs-Nr.: 8000394001  
File reference

Seite 1 von 2  
Page 1 of 2

Algemeine Angaben: Siehe Seite 1 des Zertifikates  
General information: See also page 1 of the Certificate

Typenbezeichnung: VARITECTOR SPC und VARITECTOR SSC  
Type Description

#### Übersicht Parameter VARITECTOR SSC / Overview Parameter VARITECTOR SSC

Typ	max. unverteilter I <sub>pk</sub> in 1 10 <sup>-6</sup> s	max. unverteilter I <sub>pk</sub> in 1 10 <sup>-4</sup> s	eingeschränkt unverteilter I <sub>pk</sub> in 1 10 <sup>-6</sup> s	eingeschränkt unverteilter I <sub>pk</sub> in 1 10 <sup>-4</sup> s	SPD	FFD in 1 10 <sup>-6</sup> s	Max. StL
VSSC CL	8,1	10,94	0	1,96	80,74%	1,96	2
VSSC CL PG	7,1	10,94	0	1,96	80,74%	1,96	2
VSSC CL	7	30,1	0	0,3	87,91%	0,3	3
VSSC SL PG	7	30,1	0	0,3	87,91%	0,3	3
VSSC MOV	2,3	22,75	0,75	0	79,02%	0	3
VSSC MOV	1	9	0	0	100,00%	0	3
VSSC TAZ	2,3	24,25	0,25	0	79,02%	0	3
VSSC TAZ	2,3	24,75	0,75	0	79,02%	0	3
VSSC CL	8,1	10,94	0	1,96	80,74%	1,96	2
VSSC TR CL	8,1	10,94	0	1,96	80,74%	1,96	2
VSSC TR CL PG	7,1	10,94	0	1,96	80,74%	1,96	2
VSSC SL	7	40,7	0	1,8	86,87%	1,8	3
VSSC SL PG	7	40,7	0	1,8	86,87%	1,8	3
VSSC TR SL	7	40,7	0	1,8	86,87%	1,8	3
VSSC TR SL PG	7	40,7	0	1,8	86,87%	1,8	3
VSSC MOV	2,3	22,75	0,75	0	79,02%	0	3
VSSC MOV	1	9	0	0	100,00%	0	3
VSSC TAZ	2,3	24,25	0,25	0	79,02%	0	3
VSSC TAZ	2,3	24,75	0,75	0	79,02%	0	3
VSSC TR MOV	1	9	0	0	100,00%	0	3
VSSC TR TAZ	2,3	24,25	0,25	0	87,91%	0,3	3
VSSC TR TAZ	2,3	24,75	0,75	0	87,91%	0,3	3
VSSC RS485/RS485 PA	0	43,75	0	2,26	80,26%	2,26	3
VSSC RS485	0	43,75	0	2,26	80,26%	2,26	3
VSSC RS485 PA	3,3	10,75	2	1,75	80,37%	1,75	3
VSSC RTD	4	44,75	7	1,75	84,94%	1,75	3
VSSC RTD EX	4	43,75	6	2,26	80,26%	2,26	3



### Anlage 1 zum Zertifikat Nr.:

Annex 1 to Certificate No.:

**44 799 11 394001-001**

Rev. 1

Aktivierungs-Nr.: 8000394001  
File reference

Seite 2 von 2  
Page 2 of 2

Algemeine Angaben: Siehe Seite 1 des Zertifikates  
General information: See also page 1 of the Certificate

Typenbezeichnung: VARITECTOR SPC und VARITECTOR SSC  
Type Description

#### Übersicht Parameter VARITECTOR SPC / Overview Parameter VARITECTOR SPC

Typ	max. unverteilter I <sub>pk</sub> in 1 10 <sup>-6</sup> s	max. unverteilter I <sub>pk</sub> in 1 10 <sup>-4</sup> s	eingeschränkt unverteilter I <sub>pk</sub> in 1 10 <sup>-6</sup> s	eingeschränkt unverteilter I <sub>pk</sub> in 1 10 <sup>-4</sup> s	SPD	FFD in 1 10 <sup>-6</sup> s	Max. StL
VSPC CL	13,6	20,45	0	1,96	80,27%	1,96	3
VSPC CL PG	11,7	20,4	0	3,7	80,27%	3,75	3
VSPC CL HF	15,6	20,45	0	2,95	80,96%	2,95	3
VSPC CL HF R	16,1	20,4	0	4,7	80,26%	4,75	3
VSPC SL	9	31,7	1	0,3	79,02%	0,3	3
VSPC SL PG	4,5	30,25	1	10,94	80,02%	10,7	3
VSPC SL MOV	36	107	0	7	80,02%	7,06	3
VSPC SL MOV	12	31,75	0	4,29	80,04%	4,29	3
VSPC RS485 R	15,3	167	0	0	80,00%	0,00	3
VSPC RS485	15,6	20,45	0	2,95	80,04%	2,95	3
VSPC TAZ PG	13,6	20,45	0	1,96	80,07%	1,96	3
VSPC MOV ZCH	0	0	0	0	100,00%	0,00	3
VSPC MOV ZCH	2,3	22,75	0,75	0	100,00%	0,00	3
VSPC MOV ZCH R	2,3	12,85	0,75	0	100,00%	0,00	3
VSPC TAZ ZCH	2,3	24,25	0,25	0	100,00%	0,00	3
VSPC TAZ ZCH	2,3	24,25	0,25	0	100,00%	0,00	3

# Lightning and surge protection for control and instrumentation signals

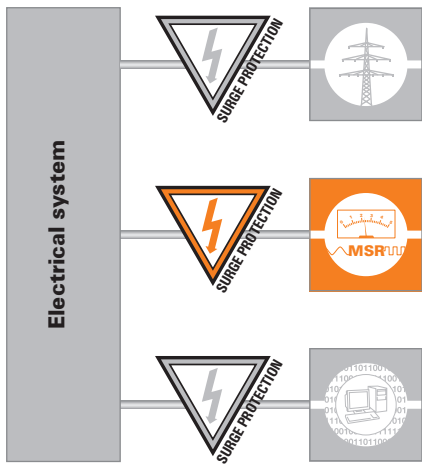

breakdowns or malfunctions can lead to exorbitant costs. As the standards covering low control voltages do not specify many parameters, the use of surge protection, apart from lightning protection zoning concepts, has to be classified according to type of signal, application circuit and the anticipated interference voltage phenomena.

## Types of interference voltage

Transient surges coupled into a system via one or more coupling mechanisms occur as normal- or common-mode interference. These are measured as longitudinal or transverse voltages and, depending on the circuit, designated as symmetrical or asymmetrical voltages. (For further information see the "Principles" chapter.)

## Basic classification

The current scope of automation technology has resulted in a wide range of applications for surge protection in the field of instrumentation and control engineering. One important prerequisite is the consistent use of coordinated surge protection in all sections of the plant or building. In industry, instrumentation and control systems are important areas and

## Types of signal

### Binary signals SL <sup>△</sup> (symmetrical loop)

These are two-wire signals with a common reference potential which are required by, for example, by switches, PLC switch outputs, photoelectric barriers, position sensors, solenoid valves, warning lamps, PLC inputs, etc. Normally, these signals have a common reference potential that can be either connected or not connected to earth potential, depending on the type of protection. The coupled transient interference is primarily common-mode interference.

### Analogue signals CL <sup>△</sup> (current loop)

Measuring circuits are normally designed as two-wire current loops or voltage signals without a common reference potential, like the 0(4)...20 mA current loop.

The coupled transient interference is primarily normal-mode interference. For temperature measurements with the PT100 measuring shunt in the three-wire version, the voltage drop at the shunt is measured via the third wire. This must be included in the system of protection.

The PT100 measuring shunt is also available in a four-wire version in which the voltage drop at the shunt is measured via the two additional lines without additional line losses in the PT100 measuring circuit. The coupled transient normal-mode interference occurs between the various wires.

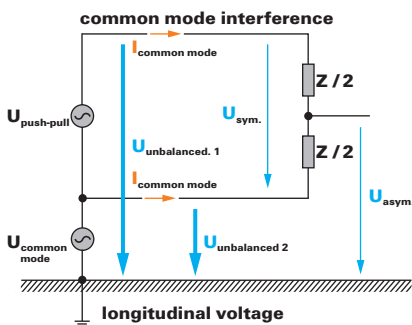

Common-mode interference (asymmetrical interference):  
Common-mode voltage between conductor and reference potential. (earth)/mainly caused by capacitive coupling (electrical field)

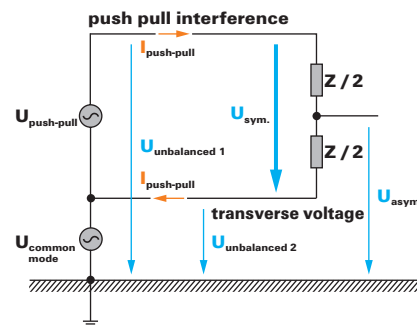

Normal-mode interference (symmetrical interference):  
Normal-mode voltage between supply and return conductor load and interference source connected in series, e.g. inductive (magnetic field) or conductive coupling (common impedance)

Essential information for users can be found in the IEC 61643-22 standard (application standard for measurement and control signals) and in the IEC 62305-4 standard (application standard for installing internal lightning protection). It is important to determine which protection category is required. There are divisions for D1 (lightning protection), C2 (surge protection / overvoltage protection) and C1 (end device protection). These categories or classes are specified for the following products. All products were subjected to a test in accordance with product standard IEC 61643-21:2008.

**Binary signals**

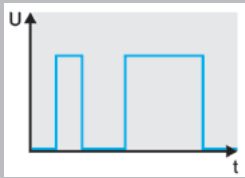

Two-wire, usually with common reference potential, e.g. signals from binary sensors, actuators and indicators such as limit switches, probes, position sensors, photoelectric barriers, contactors, solenoid valves, warning lamps.

Protection for binary signals connected to earth potential.

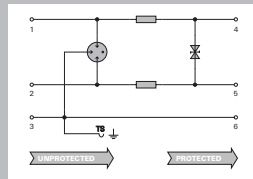

Protection for binary signals not connected to earth potential.

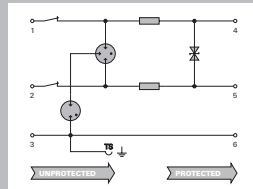

Protection for two-, three- and four-wire versions.

**Type**

- VSPC 2SL **Page B.30**
- VSPC 4SL **Page B.34**
- VSPC 3/4 **Page B.38**
  
- VSPC GDT **Page B.40**
- VSPC MOV **Page B.42**
- VSPC TAZ **Page B.44**
- VSPC UKO **Page B.46**

- VSSC6 SL LD **Page B.74**
- VSSC6 TR SL LD **Page B.76**
- VSSC6 SLFG LD **Page B.74**
- VSSC6 TR SLFG LD **Page B.76**

- VSSC6 MOV **Page B.78**
- VSSC6 TR MOV **Page B.80**
- VSSC6 GDT **Page B.82**
- VSSC6 TR GDT **Page B.84**
- VSSC6 TAZ **Page B.86**
- VSSC6 TR TAZ **Page B.86**
- VSSC6 RTD **Page B.90**

**Type**

- VSSC4 SL **Page B.96**
- VSSC4 SL FG **Page B.96**
- VSSC4 MOV **Page B.98**
- VSSC4 GDT **Page B.100**
- VSSC4 TAZ **Page B.102**
- VSSC4 RC **Page B.104**

- VSPC 2SL EX **Page B.152**
- VSPC 4SL EX **Page B.154**
- VSPC 3/4 wire EX **Page B.156**
- VSSC4 SL FG EX **Page B.164**
- VSSC4 GDT EX **Page B.166**
- VSSC6 RTD EX **Page B.172**

- MCZ OVP HF **Page B.110**
- MCZ OVP CL **Page B.112**

**Analogue signals**

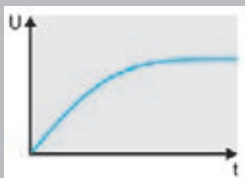

Two-, three- and four-wire versions without common reference potential.

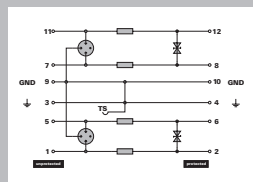

Signals from current loops (analogue measurements from sensors over long distances), 4...20 mA, 0...20 mA, etc., e.g. level measurements.

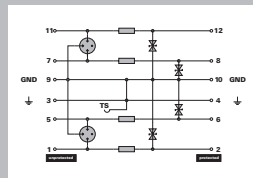

Signals from voltage sensors (analogue measurements from sensors over short distances), 0...10 V, PT100, etc., e.g. temperature measurements.

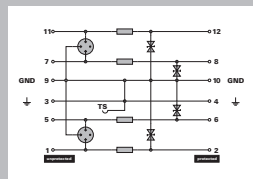

**Type**

- VSPC 1CL **Page B.16**
- VSPC 2CL **Page B.20**
- VSPC 1CL PW **Page B.28**
- VSPC RS485 **Page B.48**

- VSSC6 CL **Page B.70**
- VSSC6 TR CL **Page B.72**
- VSSC6 CLFG **Page B.70**
- VSSC6 TR CLFG **Page B.168**
- VSSC6 RS485 **Page B.88**
- VSSC6 RS485 DP **Page B.89**
- VSSC6 RS232 **Page B.88**

- VSSC4 CL **Page B.94**
- VSSC4 CL FG **Page B.94**

- VSPC 2SL EX **Page B.152**
- VSPC 4SL EX **Page B.154**
- VSPC 3/4 wire EX **Page B.156**
- VSSC4 SL FG EX **Page B.164**
- VSSC4 GDT EX **Page B.166**
- VSSC6 RTD EX **Page B.172**

**Type**

- MCZ OVP SL **Page B.113**
- MCZ OVP SL FG **Page B.118**
- MCZ OVP Filter **Page B.119**
- MCZ OVP TAZ **Page B.121**
- JACKPAC® **Page D.19**
- RSU **Page B.122**

# VARITECTOR SPC

## Pluggable surge protection for the measurement and control industry VARITECTOR SPC

Weidmüller's VARITECTOR SPC pluggable surge protection is remarkable for its combination of extremely high protective functionality and compact dimensions. It is suited for use in measurement and control circuits. The size is made possible by the selection of INSTA dimensions, with a width of 17.8 mm (1TE).

Two versions are available:

- VSPC: a surge protector **with no** monitoring function
- VSPC R: a surge protector **with** monitoring function

The base components are plugged in to form a direct earthing contact via the mounting rail. This saves you time when making the connection. The VARITECTOR SPC series is optimally designed for compact installations in process automation, industrial automation and building automation. The two-stage surge-protection base components are equipped with gas discharge tubes, suppressor diodes (TVS) and decoupling components. Individual protective components (such as gas-filled spark gaps, varistors and suppressor diodes) supplement this product line. IEC 62305 requires that a periodic inspection of surge protection products be conducted. The functionality of all VARITECTOR SPC modules can be tested using testing equipment (such as the V-TEST Basic) that is available separately. The VARITECTOR SPC R modules also feature an internal monitoring function. The green LED signals when the protection function is ready. The red LED signals an error.

Up to ten modules can be wired together in succession. The modules alert an evaluative module (the VSPC CONTROL UNIT) in the event of an error. VARITECTOR SPC series surge protection is available with rated voltages of 5 V, 12 V, 24 V, 48 V and 60 V. The product's voltage level is colour-coded on the pluggable arrester. An earthing contact is established by snapping onto an earthed TS 35 rail. The TS 35 must be earthed in order to ensure safe power discharging via the terminals of up to 20 kA (8/20  $\mu$ s) and 2.5 kA (10/350  $\mu$ s). The rail must be screwed onto the earthed mounting plate for reasons of EMC. In order to optimise the protective function, a PE-contact connection should be made over the VSPC module every 60 cm for equipotential bonding. The pluggable protective element can be pulled out during operations without interrupting the measurement circuit. A testing instrument, available as a Weidmüller accessory, allows you to test the protective element in compliance with the IEC 62305-3 directive. The accessory also includes a simple mechanism for applying the wire shield.



## Overview of model types

A VARITECTOR SPC (VSPC) consists of a **pluggable component** and a separate **base component (VSPC BASE)**.

## Explanation of terms:

CL = current loop / analogue signals

SL = symmetric loop - for binary signals

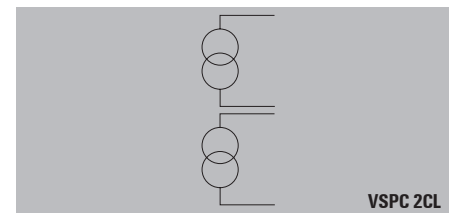
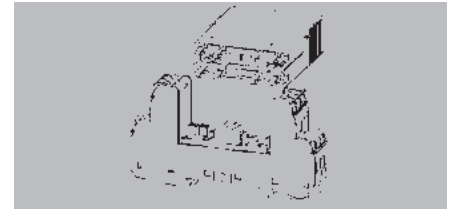

**VSPC 2CL** (CL = current loop) is a two-stage protective combination with a gas discharge tube and a suppressor diode located between the current paths. This VSPC 2CL limits the surge voltage within **two analogue signal circuits** (such as for current loops). This pluggable component can be inserted into the base (VSPC BASE 2CL). The base (VSPC BASE FG 2CL) is used when working with signal circuits which are not earthed. The VSPC 2CL HF is used in order to avoid influencing high-frequency signal circuits (this also includes the VSPC RS485 and the VSPC UKO). This protective combination is also inserted into the base mentioned above.

## Monitoring function

The **VSPC 2CL R** products feature monitor and alert functions. As well as the alert function, there are two channels available for current loops in a single housing. The special VSPC BASE 2CL R and SPC BASE 2CL FG R bases



transfer the alert function to a 2-pole screw/plug-in connection in the bases and to the VSPC CONTROL UNIT.

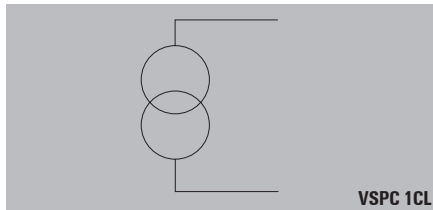

The **VSPC 1CL** is a two-stage protective combination with a gas discharge tube and a suppressor diode located between the current paths. This VSPC 1CL limits the surge voltage within **one analogue signal circuit** (such as for current loops). This pluggable component can be inserted into the base (VSPC BASE 1CL). The base (VSPC BASE FG 1CL) is used when working with signal circuits which are not earthed.

#### Monitoring function

The **VSPC 1CL R** products feature monitor and alert functions. All channels remain despite the alert function. The special VSPC BASE 1CL R and VSPC BASE 1CL FG R bases transfer the alert function to a 2-pole screw/plug-in connection in the bases and to the VSPC CONTROL UNIT.

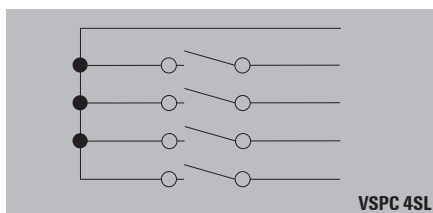

The **VSPC 4SL** is a two-stage protective combination with a gas discharge tube and a suppressor diode from the current path to the PE. This VSPC 4SL limits the surge voltage within **four binary signal circuits** (such as for alert contacts). This pluggable component can be inserted into the base (VSPC BASE 4SL). The base (VSPC BASE FG 4CL) is used

when working with signal circuits which are not earthed.

#### Monitoring function

The **VSPC 4SL R** products feature monitor and alert functions. Even with the alert function, there are still channels available for the four binary signal circuits in a single housing. The special VSPC BASE 4SL R base transfers the alert function to a 2-pole screw/plug-in connection in the base and to the VSPC CONTROL UNIT.

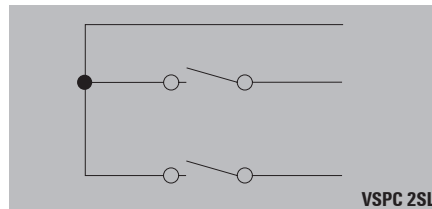

The **VSPC 2SL** is a two-stage protective combination with a gas discharge tube and a suppressor diode from the current path to the PE. This VSPC 2SL limits the surge voltage within **two binary signal circuits** (such as for alert contacts). This pluggable component can be inserted into the base (VSPC BASE 2SL). The base (VSPC BASE 2CL FG) is used when working with signal circuits which are not earthed.

#### Monitoring function

The VSPC 2SL R products feature monitor and alert functions. Even with the alert function, there are still channels available for the two binary signal circuits in a single housing. The special VSPC BASE 2SL R base transfers the alert function to a 2-pole screw/plug-in connection in the base and to the VSPC CONTROL UNIT.

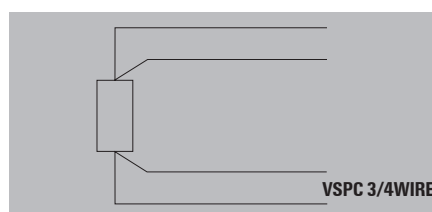

The **VSPC 3/4WIRE** is a two-stage protective combination with a gas discharge tube and a suppressor diode from the current path to the GND. This VSPC 3/4WIRE limits the surge voltage within four temperature-measurement circuits (such as for DMS or PT100/100 sensors). For non-earthed measurement circuits, we recommend using the base (VSPC BASE FG 4CL).

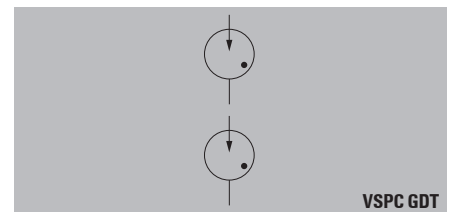

#### VSPC MOV 2CH, VSPC TAZ 2CH and VSPC GDT 2CH

Four cables can be protected with the 2CH modules. By wiring the connections differently, either two no-voltage signal lines or four binary signal lines can be protected. Two three-pole gas discharge tubes (GDTs) are used for the VSPC GDT 2CH. This universal protective circuitry limits the voltage between the signal lines and also between each signal line and the PE.

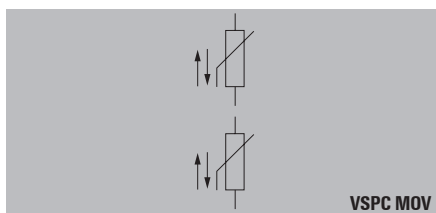
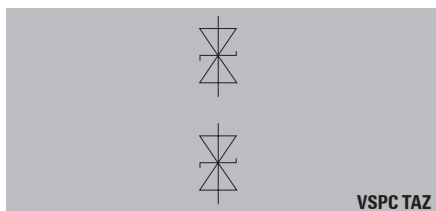

The **VSPC MOV 2CH** and **TAZ 2CH** offer one-stage protection with a varistor (MOV) or suppressor diode (TAZ or TVS) between the current paths. This makes it possible to protect a no-voltage (floating) signal circuit. Two binary signal circuits can also be protected if terminals 1 and 7 are assigned to GND / PE. These VSPC pluggable components are inserted into the base (VSPC BASE 2/4CH). The base (VSPC BASE 2/4CH FG) is used when working with signal circuits which are not earthed.

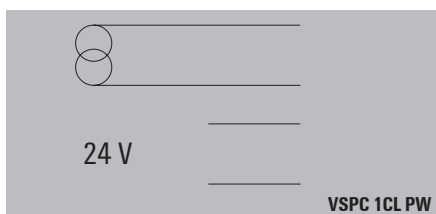

**VSPC 1CL PW (power and signal 1CL)** offers combined protection that is suitable for the 24 V DC power supply and the current loops within a device. This VSPC protects sensors with an additional 24 V DC.

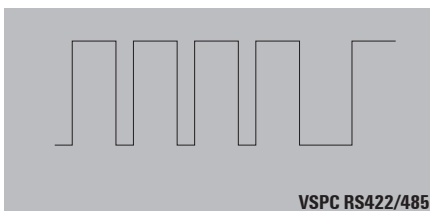

The **VSPC RS485** is a two-stage protective combination with a gas discharge tube and a suppressor diode located between the current paths. This VSPC RS485 limits the surge voltage within **two high-frequency signal circuits**. This pluggable component can be inserted into the base (VSPC BASE 2CL). The base (VSPC BASE FG 2CL) is used when working with signal circuits which are not earthed.

#### Monitoring function

The **VSPC RS485 R** product features monitoring and alert functions. Even with the alert function, there are still two channels available for current loops in a single housing. The special VSPC BASE 2CL R and VSPC BASE 2CL FG R bases transfer the alert function to a 2-pole screw/plug-in connection in the bases and to the VSPC CONTROL UNIT.

#### Earthing unit and test plug

The earthing unit can be used during installation to short out the connected wires to earth. The earthing unit is swapped out for a VSPC pluggable component before the initial commissioning. The test plug has 2.3-mm sockets. These sockets can be used by a meter to check the connected measurement circuit.

#### Applications

The pluggable INSTA housing was created in compliance with DIN 43880. It consists of a lower section (the VSPC BASE) and a pluggable component (the VSPC). The VSPC BASE is made from black PA6.6 V0. The pluggable component is made from red PA6.6 V0. The temperature range is from -40 °C to + 70 °C. The VSPC series has been tested to comply with IEC 61643-21 04/2008 and EN 61643-21. Modules were tested with categories C1, C2 and C3: with quick-rising edges with up to 300 pulses. Category D1 describes high power testing (10/350 µs lightning protection), so that the VSPC can be used according to IEC 62305-4. The base and pluggable components are colour coded according to the voltage level. This makes installation easier.

#### Colour coding

The pluggable components transfer their coding to the base element when they are plugged in for the first time. The voltage levels are also labelled with coloured Dekafix markers applied to the VSPC pluggable component. This gives you a better overview within the electrical cabinet.

Voltage level	Colour
≤ 12 V	green
24 V Binary	blue
24 V Analogue	yellow
48 V	red
≥ 60 V	violet
Special function	white

### Test possibility / V-TEST

Because the modules are pluggable, it is possible to test the VSPC visually or by using a V-TEST testing device. The VSPC can be easily tested; the user needs only to insert the VSPC pluggable component into the V-TEST. The result is then shown on the display. The VSPC R modules also feature an internal monitoring function for the arrester. An error is displayed at the defective module. The VSPC CONTROL UNIT can then transfer an alert to the control room.

### Reoccurring tests / V-TEST



The IEC 62305-3 requires testing and maintenance for lightning protection systems. This includes the testing of the arresters used in the system.

Class of protection	Interval for complete testing	Interval for visual inspection
I	2 years	1 year
II	4 years	2 years
III/IV	6 years	3 years

**Caution!** These periodic inspections may be extended with stricter requirements pertaining to special applications or regions.

### Remote error diagnostics

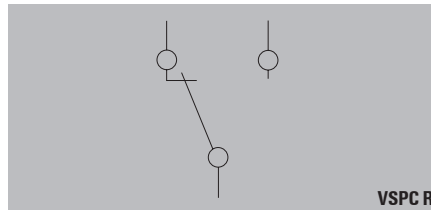

When the VSPC module labelled "R" is inserted into the corresponding "R" base component, it is then possible to use the outage alert function via a two-pole plug. This screw/plug-in connection has a clamping range from 0.5 to 1.5 mm<sup>2</sup>.

The wire stripping length is 6 to 6.5 mm. A screwdriver with a 2-mm blade width is used to turn the screw. The VSPC Rs are connected in succession to the VSPC CONTROL UNIT evaluative module. Up to ten VSPC Rs can be connected in succession to the VSPC CONTROL UNIT. The evaluative module is supplied with 24 V DC. It is then responsible for the switching and for the voltage supply to the VSPC modules. A no-voltage (floating) CO contact can then be used to alert in the event of an outage. The error on the module, with the LED changing colour from green to red. An automatic reset is carried out by the VSPC CONTROL UNIT within one minute after the failed VSPC pluggable component is replaced.

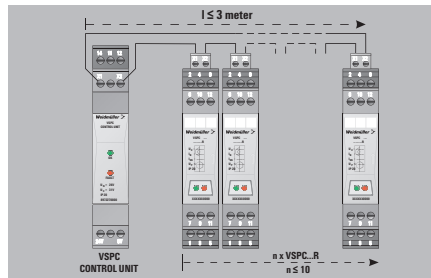

### Installation

The VSPC series is appropriate for protecting signal circuits. In order to achieve a complete protective strategy for the facility, the power feed must be protected against Type II surge voltages (for example, by using our VPU II series). For existing lightning protection facilities, Type I protection must be used (for example, by using our VPU I series). Type II protection (for example, our VPU II) is sufficient when there is no lightning protection in place.

### Fusing

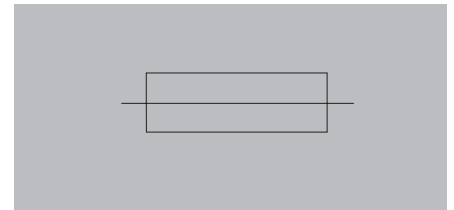

The VSPC surge protection modules are designed so that they are decoupled between the individual protective stages.

The following must be observed when providing fuse protection externally:

- Max. rated current
- Deratings curve
- Type of installation
- Application



## Discharge capacity

Testing is conducted using voltage and current pulses according to the IEC 61643-21 standard concerning surge protection in networks which process signals.

Category	Testing pulse	Surge voltage	Surge current	Pulse	Type
C1	Quick rising edge	0.5-2 kV with 1.2/50 µs	0.25-1 kA with 8/20 µs	300	Surge voltage arrester
C2	Quick rising edge	2-10 kV with 1.2/50 µs	1-5 kA with 8/20 µs	10	Surge voltage arrester
C3	Quick rising edge	≥ 1 kV with 1 kV/µs	10-100 A with 10/10.000 µs	300	Surge voltage arrester
D1	High power	≥ 1 kV	0.5-2.5 kA with 10/350 µs	2	Arrester for lightning current and surge voltages

Category C reflects the interference pulses with quick-rising edges and minimised power. Category D uses quick-rising edges and high power to detail the interference pulses. This energy simulates the high-power load that stems from coupled partial lightning currents.

**More information can be found in Chapter W.**

## General technical data

Storage temperature -40 °C...+80 °C  
 Operating temperature: -40 °C...+70 °C  
 Air humidity 5%...96% RH with no condensation  
 Material: V0, IP 20

Connection: screw connection  
 screwdriver blade: 0.6 x 3.5 DIN 5264  
 (for example, 0.6x3.5x200, order no. 9010110000)  
 rated torque: 0.5 Nm  
 max. torque: 0.8 Nm  
 stripping length: 7 mm  
 solid: 0.5...4 mm<sup>2</sup>  
 flexible: 0.5...2.5 mm<sup>2</sup>  
 wire-end ferrule with plastic collar: 0.5...2.5 mm<sup>2</sup>

Remote signalling connection: screw connection  
 screwdriver blade: 0.4 x 2.0 DIN 5264  
 (for example, SD 0.4x2.0x60, order no. 9037160000)  
 max. torque: 0.2 Nm  
 stripping length: 6...6.5 mm  
 solid: 0.5...1.5 mm<sup>2</sup>

## Dimensions

Height: 90 mm  
 Height: with remote signalling contact: 98 mm  
 Depth: 69 mm  
 Width: 17.8 mm

## Accessories

### Markers

The VSPC BASE lower section can be labelled with Dekafix-5 markers. The VSPC pluggable modules are colour coded with Dekafix-5 markers according to their rated voltage.

### Shield connection

EMC SET, order number 1067470000  
 The EMC set consists of a connection component with shielding and a cable tie covered with shielding braid. The RT-1 cable tie tool (order number 1296000000) can be used to fasten the cable ties professionally.



### V-TEST

Testing device for functional tests of the pluggable VSPC, PU II and PU I surge protection.



### VSPC Ground

This plug is attached to unused wires in the base element, so that all wires have the same potential.

### VSPC TEST CONNECTOR

This plug-in component is used for measuring the signal circuits. Testing is very easy when using sockets 2.3.

# VARITECTOR SPC – Choice of device depending on the interface

Interface	Pluggable arrester	Order No. Arrester	Order No. Base	Order No. Base floating ground (FG)	Pluggable arrester with operation message (R)	Order No. Arrester	Order No. Base	Order No. Base floating ground (FG)
<b>0(4) ... 20 mA</b>	VSPC 2CL 24 V DC 0.5 A	8924470000	8924710000	8924270000	VSPC 2CL 24 V DC 0.5 A R	8951480000	8951710000	8951720000
<b>0(4) ... 20 mA</b>	VSPC 1CL 24 V DC 0.5 A	8924480000	8924730000	8924290000	VSPC 1CL 12 V DC 0.5 A R	8951540000	8951730000	8951740000
<b>0 ... 10 V</b>	VSPC 2CL 24 V DC 0.5 A	8924470000	8924710000	8924270000	VSPC 2CL 24 V DC 0.5 A R	8951480000	8951710000	8951720000
<b>0 ... 10 V</b>	VSPC 1CL 24 V DC 0.5 A	8924480000	8924730000	8924290000	VSPC 1CL 12 V DC 0.5 A R	8951540000	8951730000	8951740000
<b>ADSL</b>	VSPC Uko	8924660000	8924710000	8924270000				
<b>ADVANT</b>	VSPC 2CL HF 5 V DC	8924430000	8924710000	8924270000	VSPC 2CL HF 5 V DC R	8951680000	8951710000	8951720000
<b>ARCNET (Plus)</b>	VSPC RS485 2ch	8924670000	8924710000	8924270000	VSPC RS485 2ch R	8951670000	8951710000	8951720000
<b>ASI</b>	PU III R 48 V DC	8860350000			PU III R 48 V DC	8860350000		
	PU III R 24 V DC	8860360000			PU III R 24 V DC	8860360000		
<b>BITBUS</b>	VSPC 2CL HF 12 V DC	8924460000	8924710000	8924270000	VSPC 2CL 12 V DC 0.5 A R	8951470000	8951710000	8951720000
<b>BLN (Building Level Network)</b>	VSPC 2CL HF 12 V DC	8924460000	8924710000	8924270000	VSPC 2CL 12 V DC 0.5 A R	8951470000	8951710000	8951720000
<b>CAN-Bus</b>	VSPC 1CL 24 V DC 0.5 A	8924480000	8924730000	8924290000	VSPC 1CL 12 V DC 0.5 A R	8951540000	8951730000	8951740000
<b>CAN-Bus</b>	VSPC 2CL HF 12 V DC	8924460000	8924710000	8924270000	VSPC 2CL HF 12 V DC R	8951690000	8951710000	8951720000
<b>C-BUS</b>	VSPC 2CL HF 12 V DC	8924460000	8924710000	8924270000	VSPC 2CL HF 12 V DC R	8951690000	8951710000	8951720000
<b>CC-LINK</b>	VSPC 2CL HF 12 V DC	8924460000	8924710000	8924270000	VSPC 2CL HF 12 V DC R	8951690000	8951710000	8951720000
<b>Data Highway (Plus), DH+</b>	VSPC 2CL HF 12 V DC	8924460000	8924710000	8924270000	VSPC 2CL HF 12 V DC R	8951690000	8951710000	8951720000
<b>Datex-P</b>	VSPC 2CL HF 12 V DC	8924460000	8924710000	8924270000	VSPC 2CL HF 12 V DC R	8951690000	8951710000	8951720000
<b>DeviceNet</b>	VSPC 2CL HF 12 V DC	8924460000	8924710000	8924270000	VSPC 2CL HF 12 V DC R	8951690000	8951710000	8951720000
<b>DIN measurement bus</b>	VSPC 2CL HF 12 V DC	8924460000	8924710000	8924270000	VSPC 2CL HF 12 V DC R	8951690000	8951710000	8951720000
<b>Dupline/Miniplex</b>	VSPC 1CL 12 V DC 0.5 A	8924450000	8924730000	8924290000	VSPC 1CL 12 V DC 0.5 A R	8951540000	8951730000	8951740000
<b>EIB (European Installation Bus)</b>	VSPC 1CL 24 V DC 0.5 A	8924480000	8924730000	8924290000	VSPC 1CL 24 V DC 0.5 A R	8951550000	8951730000	8951740000
<b>ET 200</b>	VSPC 1CL 5 V DC 0.5 A	8924420000	8924730000	8924290000	VSPC 1CL 5 V DC 0.5 A R	8951530000	8951730000	8951740000
<b>E1</b>	VSPC Uko	8924660000	8924710000	8924270000				
	VSPC 2CL HF 5 V DC	8924430000	8924710000	8924270000	VSPC 2CL HF 5 V DC R	8951680000	8951710000	8951720000
<b>FIPIO/FIPWAY</b>	VSPC 2CL HF 5 V DC	8924430000	8924710000	8924270000	VSPC 2CL HF 5 V DC R	8951680000	8951710000	8951720000
<b>Genius I/O Bus</b>	VSPC 2CL 12 V DC 0.5 A	8924440000	8924710000	8924270000	VSPC 2CL 12 V DC 0.5 A R	8951470000	8951710000	8951720000
<b>Hart</b>	VSPC 1CL 24 V DC 0.5 A	8924480000	8924730000	8924290000	VSPC 1CL 24 V AC 0.5 A R	8951560000	8951730000	8951740000
<b>HDSL</b>	VSPC Uko	8924660000	8924710000	8924270000				
<b>IEC-BUS</b>	VSPC 2CL HF 5 V DC	8924430000	8924710000	8924270000	VSPC 2CL HF 5 V DC R	8951680000	8951710000	8951720000
<b>ISDN Basic connection (Uko-Bus)</b>	VSPC Uko	8924660000	8924710000	8924270000				
<b>Cathodic corrosion prevention</b>	VSPC GDT 2ch 90 V 20 kA	8924570000	8924740000	8924300000				
<b>LON™ (Works)</b>	VSPC 1CL 48 V AC 0.5 A	8924520000	8924730000	8924290000				
<b>LRE networks</b>	VSPC 2CL HF 5 V DC	8924430000	8924710000	8924270000	VSPC 2CL HF 5 V DC R	8951680000	8951710000	8951720000
<b>LUXMATE-Bus</b>	VSPC 2CL HF 24 V DC	8924510000	8924710000	8924270000	VSPC 2CL HF 24 V DC R	8951700000	8951710000	8951720000
<b>M-Bus (Remote readout of counter)</b>	VSPC 1CL 48 V AC 0.5 A	8924520000	8924730000	8924290000	VSPC 1CL 24 V DC 0.5 A R	8951550000	8951730000	8951740000
<b>MODBUS-(PLUS)</b>	VSPC 2CL HF 12 V DC	8924460000	8924710000	8924270000	VSPC 2CL HF 12 V DC R	8951690000	8951710000	8951720000
<b>MPI-Bus</b>	VSPC RS485 2ch	8924670000	8924710000	8924270000				
<b>N1 LAN</b>	VSPC 2CL HF 5 V DC	8924430000	8924710000	8924270000	VSPC 2CL HF 5 V DC R	8951680000	8951710000	8951720000
<b>N2-Bus</b>	VSPC 2SL 5 V DC 0.5 A	8924210000	8924720000	8924280000	VSPC 2SL 5 V DC 0.5 A R	8951610000	8951770000	8951780000
<b>P-NET</b>	VSPC 2CL HF 12 V DC	8924460000	8924710000	8924270000	VSPC 2CL HF 12 V DC R	8951690000	8951710000	8951720000
<b>Proconic CS31</b>	VSPC 1CL 12 V DC 0.5 A	8924450000	8924730000	8924290000	VSPC 1CL 12 V DC 0.5 A R	8951540000	8951730000	8951740000
	VSPC 2CL HF 12 V DC	8924460000	8924710000	8924270000	VSPC 2CL HF 12 V DC R	8951690000	8951710000	8951720000
<b>Proconic T200</b>	VSPC 2CL HF 12 V DC	8924460000	8924710000	8924270000	VSPC 2CL HF 12 V DC R	8951690000	8951710000	8951720000
<b>Profibus DP (FMS)</b>	VSPC 2CL HF 5 V DC	8924430000	8924710000	8924270000	VSPC 2CL HF 5 V DC R	8951680000	8951710000	8951720000
	VSPC 2CL HF 12 V DC	8924460000	8924710000	8924270000	VSPC 2CL HF 12 V DC R	8951690000	8951710000	8951720000
<b>Process-Bus Panel-Bus</b>	VSPC 2CL HF 12 V DC	8924460000	8924710000	8924270000	VSPC 2CL HF 12 V DC R	8951690000	8951710000	8951720000
<b>PT100</b>	VSPC 3/WIRE 24 V DC	8924550000	8924740000	8924300000				
<b>P-Bus</b>	PU III R 24 V DC	8860360000			PU III R 24 V DC	8860360000		
<b>PSM-EG-RS422...</b>	VSPC 2CL HF 12 V DC	8924460000	8924710000	8924270000	VSPC 2CL HF 12 V DC R	8951690000	8951710000	8951720000
<b>PSM-EG-RS485...</b>	VSPC 2CL HF 12 V DC	8924460000	8924710000	8924270000	VSPC 2CL HF 12 V DC R	8951690000	8951710000	8951720000
<b>RACKBUS</b>	VSPC 2CL HF 5 V DC	8924430000	8924710000	8924270000	VSPC 2CL HF 5 V DC R	8951680000	8951710000	8951720000
<b>RS422A, V.11, X.27, RS423A</b>	VSPC 2CL HF 12 V DC	8924460000	8924710000	8924270000	VSPC 2CL HF 12 V DC R	8951690000	8951710000	8951720000
<b>RS449</b>	VSPC 2CL HF 12 V DC	8924460000	8924710000	8924270000	VSPC 2CL HF 12 V DC R	8951690000	8951710000	8951720000
<b>RS485</b>	VSPC RS485 2ch	8924670000	8924710000	8924270000	VSPC RS485 2ch R	8951670000	8951710000	8951720000
<b>RS232-C/V.24</b>	VSPC 2CL HF 12 V DC	8924460000	8924710000	8924270000	VSPC 2CL HF 12 V DC R	8951690000	8951710000	8951720000
<b>SDLC</b>	VSPC 2CL HF 12 V DC	8924460000	8924710000	8924270000	VSPC 2CL HF 12 V DC R	8951690000	8951710000	8951720000
<b>SDSL</b>	VSPC Uko	8924660000	8924710000	8924270000				
<b>SecurLan-LON™-Bus</b>	VSPC 1CL 12 V DC 0.5 A	8924450000	8924730000	8924290000	VSPC 1CL 12 V DC 0.5 A R	8951540000	8951730000	8951740000
<b>SHDSL</b>	VSPC Uko	8924660000	8924710000	8924270000				
<b>SINEC L1</b>	VSPC 2CL HF 5 V DC	8924430000	8924710000	8924270000	VSPC 2CL HF 5 V DC R	8951680000	8951710000	8951720000
<b>SINEC L2 DP</b>	VSPC 2CL HF 5 V DC	8924430000	8924710000	8924270000	VSPC 2CL HF 5 V DC R	8951680000	8951710000	8951720000
<b>Profibus DP</b>	VSPC RS485 2ch	8924670000	8924710000	8924270000	VSPC RS485 2ch R	8951670000	8951710000	8951720000
<b>T-DSL</b>	VSPC Uko	8924660000	8924710000	8924270000				
<b>Telephone analog</b>	VSPC Uko	8924660000	8924710000	8924270000				
<b>TTY, 0(4) - 20 mA</b>	VSPC 2CL 24 V DC 0.5 A	8924470000	8924710000	8924270000	VSPC 2CL 24 V DC 0.5 A R	8951480000	8951710000	8951720000
<b>U-BUS</b>	VSPC GDT 2ch 90 V 20 kA	8924570000	8924740000	8924300000				
<b>VDSL</b>	VSPC Uko	8924660000	8924710000	8924270000				
<b>V.35</b>	VSPC 2CL HF 5 V DC	8924430000	8924710000	8924270000	VSPC 2CL HF 5 V DC R	8951680000	8951710000	8951720000
<b>X.21/X.24</b>	VSPC 2CL HF 12 V DC	8924460000	8924710000	8924270000	VSPC 2CL HF 12 V DC R	8951690000	8951710000	8951720000
<b>X.25/X.31</b>	VSPC 2CL HF 12 V DC	8924460000	8924710000	8924270000	VSPC 2CL HF 12 V DC R	8951690000	8951710000	8951720000

This table contains recommendations for the choice of device. Our technical consultants will be glad to assist you with your individual requirements.

# VARIRECTOR SPC

## Pluggable lightning and surge protection for measurement and control circuits

**Pluggable lightning and surge protection for 2 analogue signals or 4 binary signals in measurement/control circuits – with integrated error detection and alert functions in only 17.8 mm width.**

Our pluggable VARIRECTOR SPC surge protection is characterised by highest protective functions with compact dimensions. The arrester of the modules can be removed, measured or exchanged during running operation impedance-neutral – without interrupting the measuring circuit. These features make this product the ideal secure protection mechanism for interfaces within instrumentation and control circuits.

Maintenance intervals are simplified by the V-TEST test unit, which is used for testing the function of the VARIRECTOR SPC. This test method satisfies the requirements of standard IEC 62305.

With the VARIRECTOR SPC R modules, error detection and error messages are realised by internal monitoring. The green LED indicates the active protective function. The red LED indicates a fault condition. This information is transmitted to the V-Control evaluation unit. From there, the information can be sent across to e.g. a controller.

Due to the impedance-neutral removing of the arrester, the VARIRECTOR SPC modules can be used instead of terminals. For four binary signals or two analogue signals, just 17.8 mm of space on the mounting rail is used. By simply snapping onto a grounded mounting rail, time savings are also ensured when connecting. A colour code identifies the various voltage levels for all VARIRECTOR SPC modules. This simplifies maintenance work during operation. The EMC set offers additional convenience for connecting shielded cables. All VARIRECTOR products comply with the latest IEC 61643-21:2008 requirement for a new overstress mode.

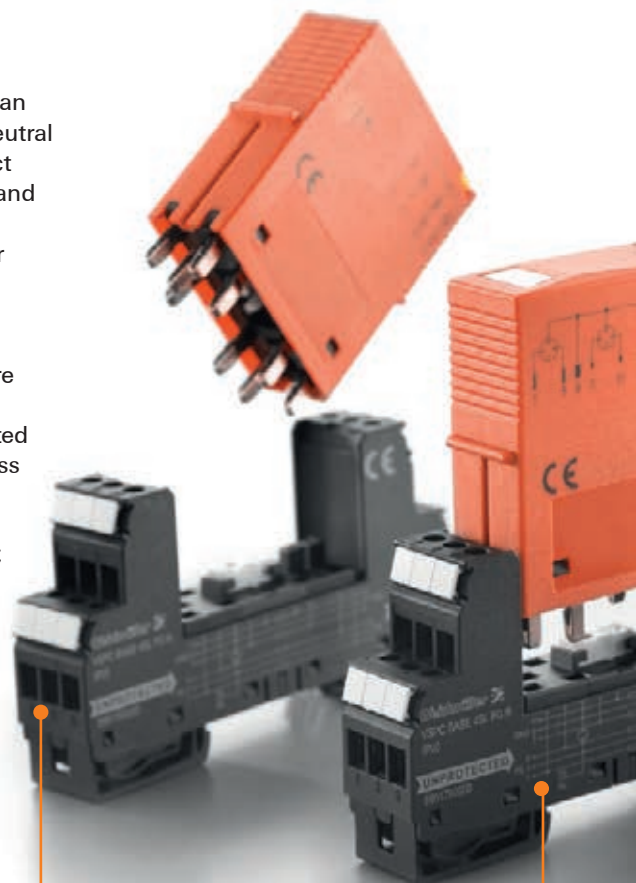

### Space-saving

Saves space in the switching cabinet: 4 binary signals or 2 analogue signals on 17.8 mm.



### Standard-conformant

Usable in accordance with installations standard IEC 62305: safely discharges high impulse currents up to 20 kA (8/20 µs) and 2.5 kA (10/350 µs) to PE. Tested for class D1, C1 and C2 to IEC 61643-21:2008.





**Monitoring function**

Status display and message function: the protective function can be evaluated externally.



**Quick identification**

Colour-coded marking: simple identification of the different voltage levels in the switching cabinet.

- ≤ 12 V = green
- 24 V = binary signal, blue
- 24 V = analogue signal, yellow
- 48 V = red
- 60 V = violet
- special function = white

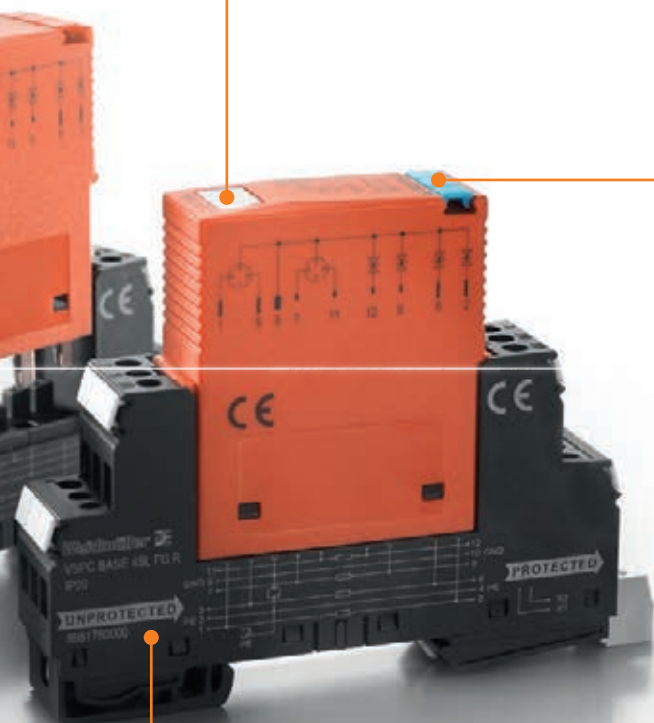

**Large variety**

A solution for every type of surge protection: current loops and binary signals as well as integrated components and combinations of current loops and voltage supply e.g. 24 V.



**Accessories**

**EMC-set**

Consisting of shield connection and cable binder with shielded sheathing, the EMC set facilitates simple connection of the cable shield to the clamping yoke connections of the VARITECTOR SPC modules.



**V-TEST**

Instrument for testing the protective function of the product families: PU I, PU II and VSPC to IEC 62305 (periodic testing).



## VARITECTOR SPC

### VSPC 1CL - protection for one analogue signal

- Optional monitoring function with status indicator and alert function
- Pluggable arrester (impedance-neutral plugging/unplugging without interruption)
- Can be tested with the V-TEST testing device
- Optional version with floating earth PE connection to avoid voltage potential differences
- Usable in accordance with installations standard IEC 62305
- Tested in accordance with IEC 61643-21:08 D1,C1,C2,C3
- Integrated PE foot, safely discharges up to 20 kA (8/20  $\mu$ s) and 2.5 kA (10/350  $\mu$ s) to PE



**B**

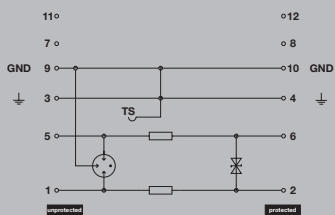

Complete module, direct earthing

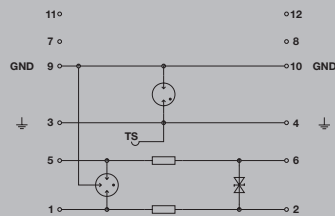

Complete module, indirect earthing

### Technical data

Dielectric strength at FG against PE	$\geq 500$ V
Volume resistance	2.20 $\Omega$
Overload - failure mode	Modus 2
Requirements category acc. to IEC 61643-21	C1, C2, C3, D1
Surge current-carrying capacity C1	< 1 kA 8/20 $\mu$ s
Surge current-carrying capacity C2	5 kA 8/20 $\mu$ s
Surge current-carrying capacity C3	100 A 10/1000 $\mu$ s
Surge current-carrying capacity D1	2.5 kA 10/350 $\mu$ s
Discharge current $I_t$ (8/20 $\mu$ s) wire-wire/wire-PE/GND-PE	2.5 kA / 2.5 kA / 2.5 kA
Discharge $I_{max}$ (8/20 $\mu$ s) wire-wire/wire-PE/GND-PE	10 kA / 10 kA / 10 kA
Lightning test $I_{imp}$ (10/350 $\mu$ s) wire-wire/wire-PE/GND-PE	2.5 kA / 2.5 kA / 2.5 kA
Type of connection	Pluggable in VSPC BASE
Storage temperature	-40 °C...+80 °C
Ambient temperature (operational)	-40 °C...+70 °C
Protection degree	IP 20
<b>Failure probability</b>	
Ages	45
MTTF	2537
SIL in compliance with IEC 61508	3
<b>Approvals</b>	
Approvals	CE, GOSTME25, OEVE, TUEV, UL
Standards	IEC 61643-21

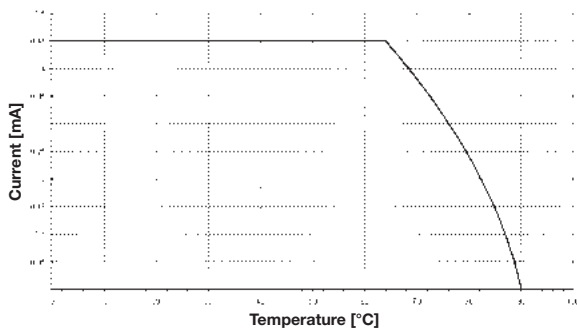

<b>Dimensions of complete module (arrester + base element)</b>	<b>no remote sig. contact</b>
Height x width x depth	mm 90 / 17.8 / 69
<b>Note</b>	The associated VSPC base element should be ordered with this. The dimension information provided refers to the complete module.

### Base elements / base to arresters



### Ordering data for base

Description	Type	Qty.	Order No.
Base element, direct earthing	VSPC BASE 1CL	1	8924730000
Base element, indirect earthing / floating earth FG	VSPC BASE 1CL FG	1	8924290000

<b>Note</b>	Technical data can be found at the end of the VARITECTOR SPC section.
-------------	---

VSPC 1CL - arrester / plug-in elements



Ordering data

	VSPC 1CL 5 V DC	VSPC 1CL 12 V DC	VSPC 1CL 24 V DC	VSPC 1CL 24 V AC
Rated voltage (AC)				24 V
Rated voltage (DC)	5 V	12 V	24 V	34 V
Max. continuous voltage, U <sub>c</sub> (AC)				28 V
Max. continuous voltage, U <sub>c</sub> (DC)	6.4 V	15 V	28 V	40 V
Rated current	450 mA	450 mA	450 mA	450 mA
Input attenuation	730 KHz	1.7 MHz	2.4 MHz	2.7 MHz
Pulse-reset capacity	≤ 20 ms	≤ 20 ms	≤ 30 ms	≤ 450 ms
Residual voltage, U <sub>r</sub> , typical	800 V	800 V	800 V	800 V
<b>Protection level</b>				
Wire-wire 1 kV/μs, typically	12 V	25 V	45 V	60 V
Wire-wire 8/20 μs, typically	12 V	25 V	45 V	60 V
Wire-PE 1kV/μs, typically	450 V	450 V	450 V	450 V
Wire-PE 8/20 μs, typically	650 V	650 V	650 V	650 V

Ordering data				
No function display	Type	VSPC 1CL 5VDC	VSPC 1CL 12VDC	VSPC 1CL 24VDC
	Order No.	<b>8924420000</b>	<b>8924450000</b>	<b>8924480000</b>
	Qty.	1 ST	1 ST	1 ST
<b>Note</b>				
		VSPC 1CL 24VAC		
		<b>8924500000</b>		
		1 ST		

Ordering data

	VSPC 1CL 48 V AC	VSPC 1CL 60 V AC
Rated voltage (AC)	48 V	60 V
Rated voltage (DC)	68 V	85 V
Max. continuous voltage, U <sub>c</sub> (AC)	60 V	72 V
Max. continuous voltage, U <sub>c</sub> (DC)	85 V	102 V
Rated current	350 mA	250 mA
Input attenuation	4.8 MHz	7.3 MHz
Pulse-reset capacity	≤ 500 ms	≤ 500 ms
Residual voltage, U <sub>r</sub> , typical	800 V	800 V
<b>Protection level</b>		
Wire-wire 1 kV/μs, typically	85 V	100 V
Wire-wire 8/20 μs, typically	85 V	100 V
Wire-PE 1kV/μs, typically	450 V	450 V
Wire-PE 8/20 μs, typically	650 V	650 V

Ordering data		
No function display	Type	VSPC 1CL 48VAC
	Order No.	<b>8924520000</b>
	Qty.	1 ST
<b>Note</b>		
		VSPC 1CL 60VAC
		<b>8924530000</b>
		1 ST





## VARITECTOR SPC

### VSPC 1CL - protection for one analogue signal with remote alert

- Optional monitoring function with status indicator and alert function
- Pluggable arrester (impedance-neutral plugging/unplugging without interruption)
- Can be tested with the V-TEST testing device
- Optional version with floating earth PE connection to avoid voltage potential differences
- Usable in accordance with installations standard IEC 62305
- Tested in accordance with IEC 61643-21:08 D1,C1,C2,C3
- Integrated PE foot, safely discharges up to 20 kA (8/20  $\mu$ s) and 2.5 kA (10/350  $\mu$ s) to PE



### Technical data

Dielectric strength at FG against PE	$\geq 500$ V
Volume resistance	2.20 $\Omega$
Overload - failure mode	Modus 2
Requirements category acc. to IEC 61643-21	C1, C2, C3, D1
Surge current-carrying capacity C1	< 1 kA 8/20 $\mu$ s
Surge current-carrying capacity C2	5 kA 8/20 $\mu$ s
Surge current-carrying capacity C3	100 A 10/1000 $\mu$ s
Surge current-carrying capacity D1	2.5 kA 10/350 $\mu$ s
Discharge current $I_n$ (8/20 $\mu$ s) wire-wire/wire-PE/GND-PE	2.5 kA / 2.5 kA / 2.5 kA
Discharge $I_{max}$ (8/20 $\mu$ s) wire-wire/wire-PE/GND-PE	10 kA / 10 kA / 10 kA
Lightning test $I_{imp}$ (10/350 $\mu$ s) wire-wire/wire-PE/GND-PE	2.5 kA / 2.5 kA / 2.5 kA
Type of connection	Pluggable in VSPC BASE
Storage temperature	-40 °C...+80 °C
Ambient temperature (operational)	-40 °C...+70 °C
Protection degree	IP 20
<b>Failure probability</b>	
Ages	45
MTTF	2537
SIL in compliance with IEC 61508	3
<b>Approvals</b>	
Approvals	CE, GOSTME25, OEVE, TUEV, UL
Standards	IEC 61643-21

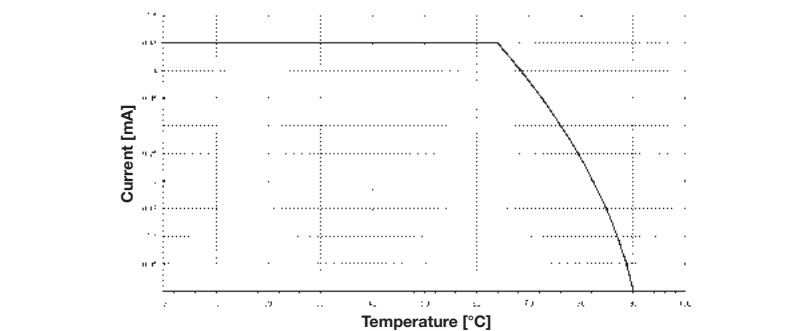
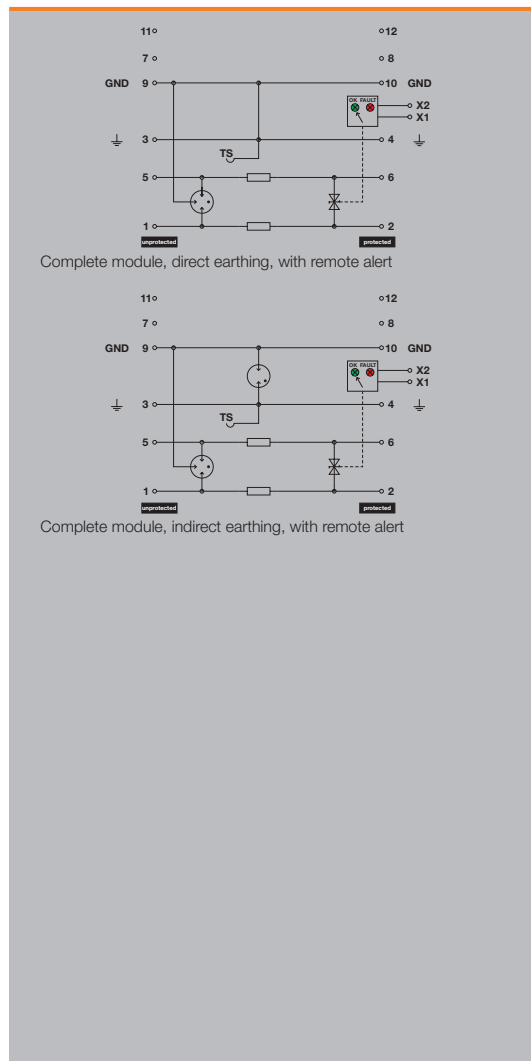

Dimensions of complete module (arrester + base element)	with remote signalling (R)
Height x width x depth	mm 98 / 17.8 / 69
<b>Note</b>	The associated VSPC base element should be ordered with this. The dimension information provided refers to the complete module.

### Base elements / base to arresters



### Ordering data for base

Description	Type	Qty.	Order No.
Base element, indirect earthing with remote contact	VSPC BASE 1CL FG R	1	8951740000
Base element, direct earthing with remote contact	VSPC BASE 1CL R	1	8951730000

**Note** Technical data can be found at the end of the VARITECTOR SPC section. Order with VSPC CONTROL UNIT.

**VSPC 1CL - arrester / plug-in components with remote alert**



**Ordering data**

	VSPC 1CL 5 V DC R	VSPC 1CL 12 V DC R	VSPC 1CL 24 V DC R	VSPC 1CL 24 V AC R
Rated voltage (AC)				24 V
Rated voltage (DC)	5 V	12 V	24 V	34 V
Max. continuous voltage, U <sub>c</sub> (AC)				28 V
Max. continuous voltage, U <sub>c</sub> (DC)	6.4 V	15 V	28 V	40 V
Rated current	450 mA	450 mA	450 mA	450 mA
Signalling contact	U <sub>N</sub> 250 V AC 0.1 A 1CO at VSPC R with VSPC CONTROL UNIT	U <sub>N</sub> 250 V AC 0.1 A 1CO at VSPC R with VSPC CONTROL UNIT	U <sub>N</sub> 250 V AC 0.1 A 1CO at VSPC R with VSPC CONTROL UNIT	U <sub>N</sub> 250 V AC 0.1 A 1CO at VSPC R with VSPC CONTROL UNIT
Optical function display	green = OK; red = arrester is defective - replace	green = OK; red = arrester is defective - replace	green = OK; red = arrester is defective - replace	green = OK; red = arrester is defective - replace
Input attenuation	730 KHz	1.7 MHz	2.4 MHz	2.6 MHz
Pulse-reset capacity	20 ms	≤ 20 ms	30 ms	≤ 450 ms
Residual voltage, U <sub>r</sub> typical	800 V	800 V	800 V	800 V
<b>Protection level</b>				
Wire-wire 1 kV/μs, typically	12 V	25 V	45 V	60 V
Wire-wire 8/20 μs, typically	12 V	25 V	45 V	60 V
Wire-PE 1kV/μs, typically	450 V	450 V	450 V	450 V
Wire-PE 8/20 μs, typically	650 V	650 V	650 V	650 V

**Ordering data**

With functional display	Type	VSPC 1CL 5VDC R	VSPC 1CL 12VDC R	VSPC 1CL 24VDC R	VSPC 1CL 24VAC R
	Order No.	<b>8951530000</b>	<b>8951540000</b>	<b>8951550000</b>	<b>8951560000</b>
	Qty.	1 ST	1 ST	1 ST	1 ST
<b>Note</b>					

**B**



## VARITECTOR SPC

### VSPC 2CL - protection for two analogue signals

- Optional monitoring function with status indicator and alert function
- Pluggable arrester (impedance-neutral plugging/unplugging without interruption)
- Can be tested with the V-TEST testing device
- Version with floating-earth PE connection for avoiding voltage potential differences
- Space-saving design for 2 analogue signals with optional alert function and no extra space required
- Usable in accordance with installations standard IEC 62305
- Tested in accordance with IEC 61643-21:08 D1,C1,C2,C3
- Integrated PE foot, safely discharges up to 20 kA (8/20  $\mu$ s) and 2.5 kA (10/350  $\mu$ s) to PE



### Technical data

Dielectric strength at FG against PE	$\geq 500$ V
Volume resistance	2.20 $\Omega$
Overload - failure mode	Modus 2
Requirements category acc. to IEC 61643-21	C1, C2, C3, D1
Surge current-carrying capacity C1	< 1 kA 8/20 $\mu$ s
Surge current-carrying capacity C2	5 kA 8/20 $\mu$ s
Surge current-carrying capacity C3	100 A 10/1000 $\mu$ s
Surge current-carrying capacity D1	2.5 kA 10/350 $\mu$ s
Discharge current $I_n$ (8/20 $\mu$ s) wire-wire/wire-PE/GND-PE	2.5 kA / 2.5 kA / 2.5 kA
Discharge $I_{max}$ (8/20 $\mu$ s) wire-wire/wire-PE/GND-PE	10 kA / 2 x 10 kA / 10 kA
Lightning test $I_{imp}$ (10/350 $\mu$ s) wire-wire/wire-PE/GND-PE	2.5 kA / 2.5 kA / 2.5 kA
Type of connection	Pluggable in VSPC BASE
Storage temperature	-40 °C...+80 °C
Ambient temperature (operational)	-40 °C...+70 °C
Protection degree	IP 20
<b>Failure probability</b>	
Ages	45
MTTF	2537
SIL in compliance with IEC 61508	3
<b>Approvals</b>	
Approvals	CE, GOSTME25, OEVE, TUEV, UL
Standards	IEC 61643-21

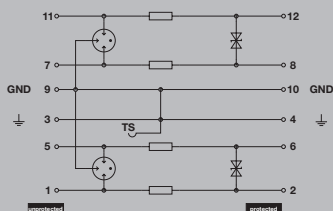

Complete module, direct earthing

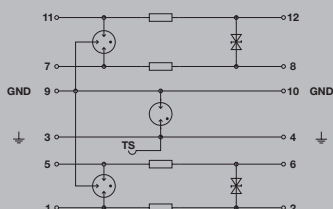

Complete module, indirect earthing

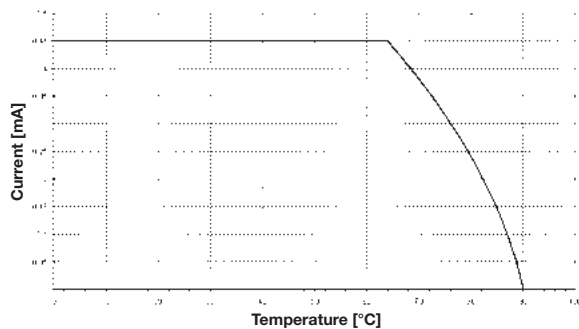

Dimensions of complete module (arrester + base element)	no remote sig. contact
Height x width x depth	mm 90 / 17.8 / 69
<b>Note</b>	The associated VSPC base element should be ordered with this. The dimension information provided refers to the complete module.

### Base elements / base to arresters



### Ordering data for base

Description	Type	Qty.	Order No.
Base element, direct earthing	VSPC BASE 2CL	1	8924710000
Base element, indirect earthing / floating earth FG	VSPC BASE 2CL FG	1	8924270000

**Note** Technical data can be found at the end of the VARITECTOR SPC section.

VSPC 2CL - arrester / plug-in elements



Ordering data

	VSPC 2CL 5 V DC	VSPC 2CL 12 V DC	VSPC 2CL 24 V DC	VSPC 2CL 24 V AC
Rated voltage (AC)				24 V
Rated voltage (DC)	5 V	12 V	24 V	34 V
Max. continuous voltage, U <sub>c</sub> (AC)				28 V
Max. continuous voltage, U <sub>c</sub> (DC)	6.4 V	15 V	28 V	40 V
Rated current	450 mA	450 mA	450 mA	450 mA
Input attenuation	730 KHz	1.7 MHz	2.3 MHz	2.7 MHz
Pulse-reset capacity	20 ms	20 ms	30 ms	450 ms
Residual voltage, U <sub>r</sub> typical	800 V	800 V	800 V	800 V
<b>Protection level</b>				
Wire-wire 1 kV/μs, typically	12 V	25 V	45 V	60 V
Wire-wire 8/20 μs, typically	12 V	25 V	45 V	60 V
Wire-PE 1kV/μs, typically	450 V	450 V	450 V	450 V
Wire-PE 8/20 μs, typically	800 V	800 V	800 V	800 V

Ordering data		VSPC 2CL 5VDC	VSPC 2CL 12VDC	VSPC 2CL 24VDC	VSPC 2CL 24VAC
No function display	Type				
	Order No.	<b>8924400000</b>	<b>8924440000</b>	<b>8924470000</b>	<b>8924490000</b>
	Qty.	1 ST	1 ST	1 ST	1 ST
<b>Note</b>					

Ordering data

	VSPC 2CL 48 V AC	VSPC 2CL 60 V AC
Rated voltage (AC)	48 V	60 V
Rated voltage (DC)	68 V	85 V
Max. continuous voltage, U <sub>c</sub> (AC)	60 V	72 V
Max. continuous voltage, U <sub>c</sub> (DC)	85 V	102 V
Rated current	350 mA	250 mA
Input attenuation	4.8 MHz	7.3 MHz
Pulse-reset capacity	500 ms	500 ms
Residual voltage, U <sub>r</sub> typical	800 V	800 V
<b>Protection level</b>		
Wire-wire 1 kV/μs, typically	85 V	100 V
Wire-wire 8/20 μs, typically	85 V	100 V
Wire-PE 1kV/μs, typically	450 V	450 V
Wire-PE 8/20 μs, typically	650 V	650 V

Ordering data		VSPC 2CL 48VAC	VSPC 2CL 60VAC
No function display	Type		
	Order No.	<b>8951490000</b>	<b>8951500000</b>
	Qty.	1 ST	1 ST
<b>Note</b>			

B



## VARITECTOR SPC

### VSPC 2CL - protection for two analogue signals with remote alert

- Optional monitoring function with status indicator and alert function
- Pluggable arrester (impedance-neutral plugging/unplugging without interruption)
- Can be tested with the V-TEST testing device
- Version with floating-earth PE connection for avoiding voltage potential differences
- Space-saving design for 2 analogue signals with optional alert function and no extra space required
- Usable in accordance with installation standard IEC 62305
- Tested in accordance with IEC 61643-21:08 D1, C1, C2, C3
- Integrated PE foot, safely discharges up to 20 kA (8/20  $\mu$ s) and 2.5 kA (10/350  $\mu$ s) to PE



#### Technical data

Dielectric strength at FG against PE	$\geq 500$ V
Volume resistance	2.20 $\Omega$
Overload - failure mode	Modus 2
Requirements category acc. to IEC 61643-21	C1, C2, C3, D1
Surge current-carrying capacity C1	< 1 kA 8/20 $\mu$ s
Surge current-carrying capacity C2	5 kA 8/20 $\mu$ s
Surge current-carrying capacity C3	100 A 10/1000 $\mu$ s
Surge current-carrying capacity D1	2.5 kA 10/350 $\mu$ s
Discharge current $I_n$ (8/20 $\mu$ s) wire-wire/wire-PE/GND-PE	2.5 kA / 2.5 kA / 2.5 kA
Discharge $I_{max}$ (8/20 $\mu$ s) wire-wire/wire-PE/GND-PE	10 kA / 2 x 10 kA / 10 kA
Lightning test $I_{imp}$ (10/350 $\mu$ s) wire-wire/wire-PE/GND-PE	2.5 kA / 2.5 kA / 2.5 kA
Type of connection	Pluggable in VSPC BASE
Storage temperature	-40 °C...+80 °C
Ambient temperature (operational)	-40 °C...+70 °C
Protection degree	IP 20
<b>Failure probability</b>	
Ages	45
MTTF	2537
SIL in compliance with IEC 61508	3
<b>Approvals</b>	
Approvals	CE, GOSTME25, OEVE, TUEV, UL
Standards	IEC 61643-21

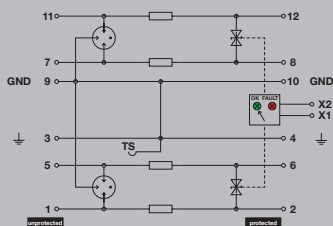

Complete module, direct earthing, with remote alert

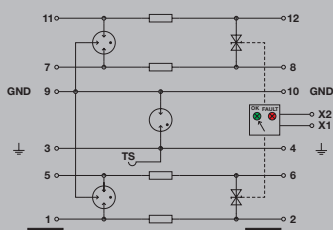

Complete module, indirect earthing, with remote alert

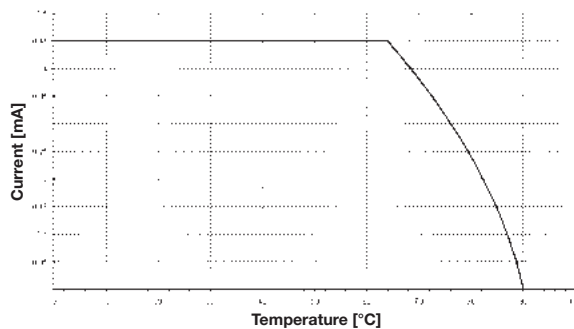

Dimensions of complete module (arrester + base element)	with remote signalling (R)
Height x width x depth	mm 98 / 17.8 / 69
<b>Note</b>	The associated VSPC base element should be ordered with this. The dimension information provided refers to the complete module.

#### Base elements / base to arresters



#### Ordering data for base

Description	Type	Qty.	Order No.
Base element, indirect earthing with remote contact	VSPC BASE 2CL FG R	1	8951720000
Base element, direct earthing with remote contact	VSPC BASE 2CL R	1	8951710000

<b>Note</b>	Technical data can be found at the end of the VARITECTOR SPC section. Order with VSPC CONTROL UNIT.
-------------	---

**VSPC 2CL - arrester / plug-in components  
with remote alert**



Ordering data	VSPC 2CL 5 V DC R	VSPC 2CL 12 V DC R	VSPC 2CL 24 V DC R	VSPC 2CL 24 V AC R
Rated voltage (AC)				24 V
Rated voltage (DC)	5 V	12 V	24 V	34 V
Max. continuous voltage, U <sub>c</sub> (AC)				28 V
Max. continuous voltage, U <sub>c</sub> (DC)	6.4 V	15 V	28 V	40 V
Rated current	450 mA	450 mA	450 mA	450 mA
Signalling contact	U <sub>n</sub> 250 V AC 0.1 A 1CO at VSPC R with VSPC CONTROL UNIT	U <sub>n</sub> 250 V AC 0.1 A 1CO at VSPC R with VSPC CONTROL UNIT	U <sub>n</sub> 250 V AC 0.1 A 1CO at VSPC R with VSPC CONTROL UNIT	U <sub>n</sub> 250 V AC 0.1 A 1CO at VSPC R with VSPC CONTROL UNIT
Optical function display	green = OK; red = arrester is defective - replace	green = OK; red = arrester is defective - replace	green = OK; red = arrester is defective - replace	green = OK; red = arrester is defective - replace
Input attenuation	730 KHz	1.7 MHz	2.3 MHz	2.7 MHz
Pulse-reset capacity	20 ms	20 ms	30 ms	450 ms
Residual voltage, U <sub>r</sub> , typical	800 V	800 V	800 V	
<b>Protection level</b>				
Wire-wire 1 kV/μs, typically	12 V	25 V	45 V	60 V
Wire-wire 8/20 μs, typically	12 V	25 V	45 V	60 V
Wire-PE 1kV/μs, typically	450 V	450 V	450 V	450 V
Wire-PE 8/20 μs, typically	800 V	800 V	800 V	800 V
<b>Ordering data</b>				
With functional display	Type	Type	Type	Type
	VSPC 2CL 5VDC R	VSPC 2CL 12VDC R	VSPC 2CL 24VDC R	VSPC 2CL 24VAC R
	<b>8951460000</b>	<b>8951470000</b>	<b>8951480000</b>	<b>1093400000</b>
	Order No.	Order No.	Order No.	Order No.
	1 ST	1 ST	1 ST	1 ST
	Qty.	Qty.	Qty.	Qty.
<b>Note</b>				





## VARITECTOR SPC

### VSPC 2CL HF - protection for two analogue signals

- Optional monitoring function with status indicator and alert function
- Pluggable arrester (impedance-neutral plugging/unplugging without interruption)
- Can be tested with the V-TEST testing device
- Version with floating-earth PE connection for avoiding voltage potential differences
- Space-saving design for 2 analogue signals with optional alert function
- Usable in accordance with installation standard IEC 62305
- Tested in accordance with IEC 61643-21:08 D1, C1, C2, C3
- Integrated PE foot, safely discharges up to 20 kA (8/20  $\mu$ s) and 2.5 kA (10/350  $\mu$ s) to PE



### Technical data

Dielectric strength at FG against PE	$\geq 500$ V
Volume resistance	2.20 $\Omega$
Overload - failure mode	Modus 2
Requirements category acc. to IEC 61643-21	C1, C2, C3, D1
Surge current-carrying capacity C1	< 1 kA 8/20 $\mu$ s
Surge current-carrying capacity C2	5 kA 8/20 $\mu$ s
Surge current-carrying capacity C3	100 A 10/1000 $\mu$ s
Surge current-carrying capacity D1	2.5 kA 10/350 $\mu$ s
Discharge current $I_t$ (8/20 $\mu$ s) wire-wire/wire-PE/GND-PE	2.5 kA / 2.5 kA / 2.5 kA
Discharge $I_{max}$ (8/20 $\mu$ s) wire-wire/wire-PE/GND-PE	10 kA / 2 x 10 kA / 10 kA
Lightning test $I_{imp}$ (10/350 $\mu$ s) wire-wire/wire-PE/GND-PE	2.5 kA / 2.5 kA / 2.5 kA
Type of connection	Pluggable in VSPC BASE
Storage temperature	-40 °C...+80 °C
Ambient temperature (operational)	-40 °C...+70 °C
Protection degree	IP 20
<b>Failure probability</b>	
Ages	45
MTTF	2537
SIL in compliance with IEC 61508	3
<b>Approvals</b>	
Approvals	CE, GOSTME25, OEVE, TUEV, UL
Standards	IEC 61643-21

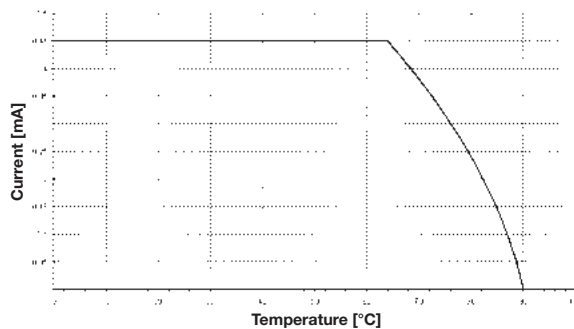
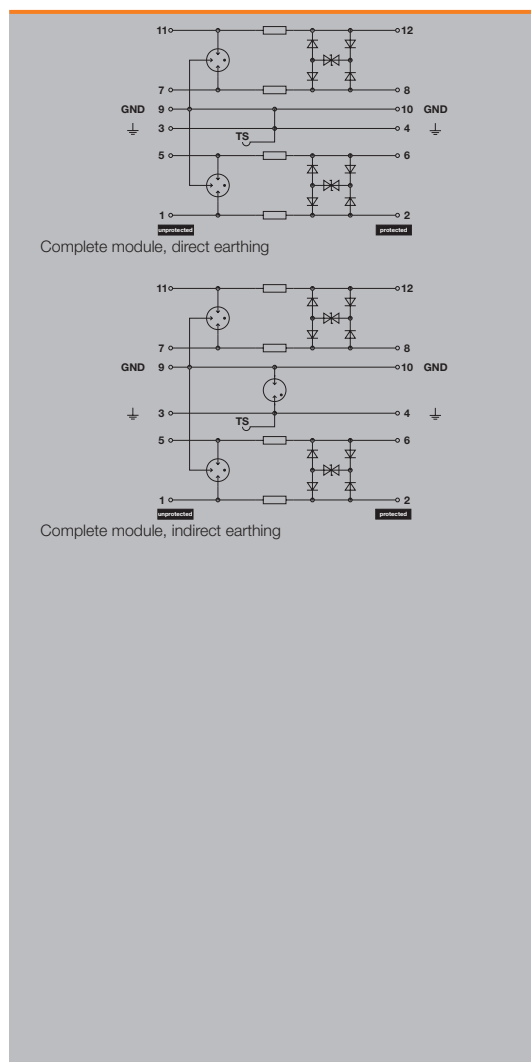

<b>Dimensions of complete module (arrester + base element)</b>	<b>no remote sig. contact</b>
Height x width x depth	mm 90 / 17.8 / 69
<b>Note</b>	The associated VSPC base element should be ordered with this. The dimension information provided refers to the complete module.

### Base elements / base to arresters



### Ordering data for base

Description	Type	Qty.	Order No.
Base element, direct earthing	VSPC BASE 2CL	1	8924710000
Base element, indirect earthing / floating earth FG	VSPC BASE 2CL FG	1	8924270000

**Note** Technical data can be found at the end of the VARITECTOR SPC section.

VSPC 2CL HF - arrester / plug-in components



Ordering data

	VSPC 2CL HF 5 V DC	VSPC 2CL HF 12 V DC	VSPC 2CL HF 24 V DC
Rated voltage (AC)			
Rated voltage (DC)	5 V	12 V	24 V
Max. continuous voltage, U <sub>c</sub> (AC)			
Max. continuous voltage, U <sub>c</sub> (DC)	6.4 V	15 V	28 V
Rated current	450 mA	450 mA	450 mA
Input attenuation	103 MHz	104 MHz	109 MHz
Pulse-reset capacity	≤ 20 ms	≤ 80 ms	≤ 40 ms
Residual voltage, U <sub>r</sub> , typical	800 V	800 V	800 V
<b>Protection level</b>			
Wire-wire 1 kV/μs, typically	12 V	25 V	45 V
Wire-wire 8/20 μs, typically	12 V	25 V	45 V
Wire-PE 1kV/μs, typically	450 V	450 V	450 V
Wire-PE 8/20 μs, typically	800 V	800 V	800 V

Ordering data	VSPC 2CL HF 5VDC	VSPC 2CL HF 12VDC	VSPC 2CL HF 24VDC
No function display			
Type	VSPC 2CL HF 5VDC	VSPC 2CL HF 12VDC	VSPC 2CL HF 24VDC
Order No.	<b>8924430000</b>	<b>8924460000</b>	<b>8924510000</b>
Qty.	1 ST	1 ST	1 ST
<b>Note</b>			

B



## VARITECTOR SPC

### VSPC 2CL HF - protection for two analogue signals with remote alert

- Optional monitoring function with status indicator and alert function
- Pluggable arrester (impedance-neutral plugging/unplugging without interruption)
- Can be tested with the V-TEST testing device
- Version with floating-earth PE connection for avoiding voltage potential differences
- Space-saving design for 2 analogue signals with optional alert function
- Usable in accordance with installation standard IEC 62305
- Tested in accordance with IEC 61643-21:08 D1, C1, C2, C3
- Integrated PE foot, safely discharges up to 20 kA (8/20 µs) and 2.5 kA (10/350 µs) to PE



#### Technical data

Dielectric strength at FG against PE	≥ 500 V
Volume resistance	2.20 Ω
Overload - failure mode	Modus 2
Requirements category acc. to IEC 61643-21	C1, C2, C3, D1
Surge current-carrying capacity C1	< 1 kA 8/20 µs
Surge current-carrying capacity C2	5 kA 8/20 µs
Surge current-carrying capacity C3	100 A 10/1000 µs
Surge current-carrying capacity D1	2.5 kA 10/350 µs
Discharge current $I_n$ (8/20 µs) wire-wire/wire-PE/GND-PE	2.5 kA / 2.5 kA / 2.5 kA
Discharge $I_{max}$ (8/20 µs) wire-wire/wire-PE/GND-PE	10 kA / 2 x 10 kA / 10 kA
Lightning test $I_{imp}$ (10/350 µs) wire-wire/wire-PE/GND-PE	2.5 kA / 2.5 kA / 2.5 kA
Type of connection	Pluggable in VSPC BASE
Storage temperature	-40 °C...+80 °C
Ambient temperature (operational)	-40 °C...+70 °C
Protection degree	IP 20
<b>Failure probability</b>	
Ages	45
MTTF	2537
SIL in compliance with IEC 61508	3
<b>Approvals</b>	
Approvals	CE, GOSTME25, OEVE, TUEV, UL
Standards	IEC 61643-21

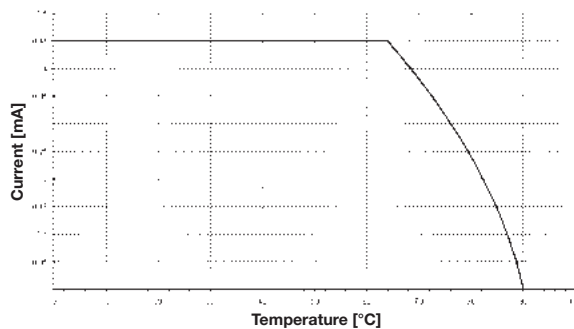
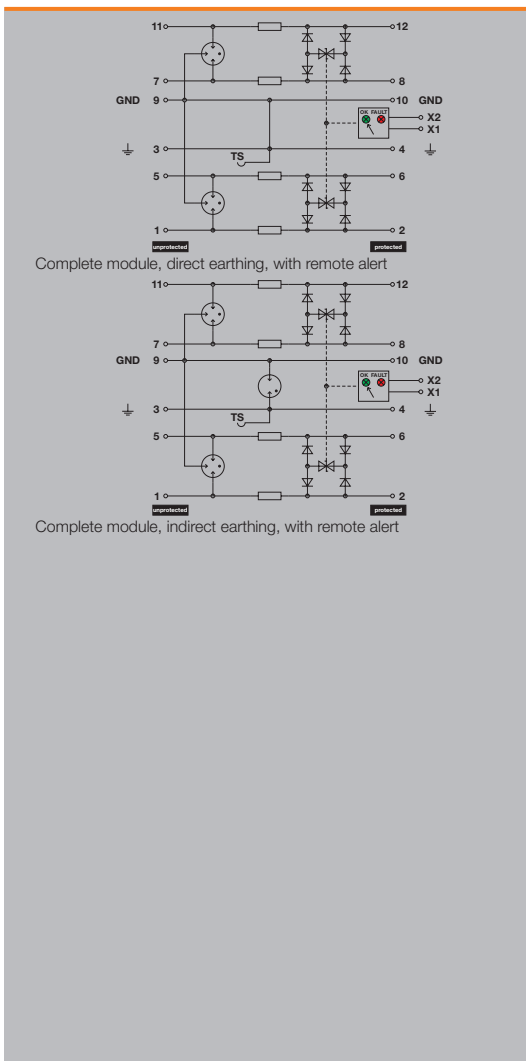

Dimensions of complete module (arrester + base element)	with remote signalling (R)
Height x width x depth	mm 98 / 17.8 / 69
<b>Note</b>	The associated VSPC base element should be ordered with this. The dimension information provided refers to the complete module.

#### Base elements / base to arresters



#### Ordering data for base

Description	Type	Qty.	Order No.
Base element, indirect earthing with remote contact	VSPC BASE 2CL FG R	1	8951720000
Base element, direct earthing with remote contact	VSPC BASE 2CL R	1	8951710000

**Note** Technical data can be found at the end of the VARITECTOR SPC section. Order with VSPC CONTROL UNIT.

**VSPC 2CL HF - arrester / plug-in components with remote alert**



Ordering data	VSPC 2CL HF 5 V DC R	VSPC 2CL HF 12 V DC R	VSPC 2CL HF 24 V DC R
Rated voltage (AC)			
Rated voltage (DC)	5 V	12 V	24 V
Max. continuous voltage, U <sub>c</sub> (AC)			
Max. continuous voltage, U <sub>c</sub> (DC)	6.4 V	15 V	28 V
Rated current	450 mA	450 mA	450 mA
Signalling contact	U <sub>N</sub> 250 V AC 0.1 A 1CO at VSPC R with VSPC CONTROL UNIT	U <sub>N</sub> 250 V AC 0.1 A 1CO at VSPC R with VSPC CONTROL UNIT	U <sub>N</sub> 250 V AC 0.1 A 1CO at VSPC R with VSPC CONTROL UNIT
Optical function display	green = OK; red = arrester is defective - replace	green = OK; red = arrester is defective - replace	green = OK; red = arrester is defective - replace
Input attenuation	103 MHz	104 MHz	109 MHz
Pulse-reset capacity	≤ 20 ms	≤ 80 ms	≤ 40 ms
Residual voltage, U <sub>r</sub> typical	800 V	800 V	800 V
<b>Protection level</b>			
Wire-wire 1 kV/μs, typically	12 V	25 V	45 V
Wire-wire 8/20 μs, typically	12 V	25 V	45 V
Wire-PE 1kV/μs, typically	450 V	450 V	450 V
Wire-PE 8/20 μs, typically	800 V	800 V	800 V
<b>Ordering data</b>			
With functional display	Type	Type	Type
	VSPC 2CL HF 5VDC R	VSPC 2CL HF 12VDC R	VSPC 2CL HF 24VDC R
	<b>Order No. 8951680000</b>	<b>Order No. 8951690000</b>	<b>Order No. 8951700000</b>
	Qty. 1 ST	Qty. 1 ST	Qty. 1 ST
<b>Note</b>			



## VARITECTOR SPC

## VSPC 1CL PW - combination of current loop protection and end device protection

- Pluggable arrester (impedance-neutral plugging/unplugging without interruption)
- Can be tested with the V-TEST testing device
- Version with floating-earth PE connection for avoiding voltage potential differences
- Usable in accordance with installations standard IEC 62305
- Tested in accordance with IEC 61643-21:08 D1,C1,C2,C3
- Tested in accordance with IEC 61643-11:09 Class III
- Integrated PE foot, safely discharges up to 20 kA (8/20  $\mu$ s) and 2.5 kA (10/350  $\mu$ s) to PE



B

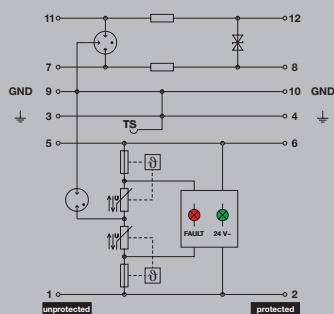

Complete module, direct earthing

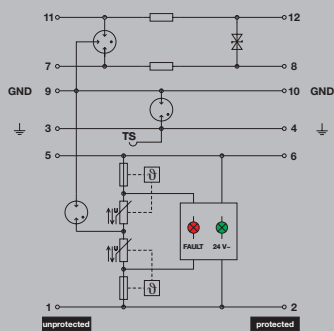

Complete module, indirect earthing

## Technical data

Measurement and control protection data	
Dielectric strength at FG against PE	$\geq 500$ V
Volume resistance	2.20 $\Omega$
Rated current	450 mA
Overload - failure mode	Modus 2
Requirements category acc. to IEC 61643-21	C1, C2, C3, D1
Surge current-carrying capacity C1	< 1 kA 8/20 $\mu$ s
Surge current-carrying capacity C2	5 kA 8/20 $\mu$ s
Surge current-carrying capacity C3	100 A 10/1000 $\mu$ s
Surge current-carrying capacity D1	2.5 kA 10/350 $\mu$ s
Standards	IEC 61643-21
Discharge current $I_t$ (8/20 $\mu$ s) wire-wire	2.5 kA / 2.5 kA / 2.5 kA
Discharge $I_{max}$ (8/20 $\mu$ s) wire-wire/wire-PE/GND-PE	10 kA / 10 kA / 10 kA
Lightning test current, $I_{imp}$ (10/350 $\mu$ s) wire-wire	2.5 kA / 2.5 kA / 2.5 kA
End device protection data	
Combined pulse $U_{oc}$	6 kV
Max. continuous voltage, $U_c$ (DC)	38 V
Residual voltage, $U_r$ typical	900 V
Rated current	10 A
General data	
Type of connection	Pluggable in VSPC BASE
Storage temperature	-40 °C...+80 °C
Requirements category acc. to IEC 61643-21	C1, C2, C3, D1
Ambient temperature (operational)	-40 °C...+70 °C
Protection degree	IP 20
Failure probability	
Ages	45
MTTF	2537
SIL in compliance with IEC 61508	3
Approvals	
Approvals	CE; GOSTME25; OEVE; TUEV; UL
Standards	IEC 61643-21

Dimensions of complete module (arrester + base element)	no remote sig. contact
Height x width x depth	mm 90 / 17.8 / 69
<b>Note</b>	The associated VSPC base element should be ordered with this. The dimension information provided refers to the complete module.

## Base elements / base to arresters



## Ordering data for base

Description	Type	Qty.	Order No.
Base element, indirect earthing / floating earth FG	VSPC BASE 1CL PW FG	1	1105700000
Base element, direct earthing	VSPC BASE 1CL PW	1	1070230000

Note	Technical data can be found at the end of the VARITECTOR SPC section.
------	---

## VSPC 1CL PW - arrester / plug-in components



## Ordering data

Rated voltage (AC)  
 Rated voltage (DC)  
 Max. continuous voltage,  $U_c$  (AC)  
 Max. continuous voltage,  $U_c$  (DC)  
 Signalling contact  
 Optical function display  
 Input attenuation  
 Pulse-reset capacity  
 Residual voltage,  $U_r$ , typical

## VSPC 1CL PW 24 V DC

34 V  
 24 V  
 27 V  
 38 V  
 For Class III protection, green = OK; red =  
 arrester is defective - replace  
 3 MHz  
 $\leq 10$  ms  
 900 V

## Protection level

Wire-wire 1 kV/ $\mu$ s, typically  
 Wire-wire 8/20  $\mu$ s, typically  
 Wire-PE 1kV/ $\mu$ s, typically  
 Wire-PE 8/20  $\mu$ s, typically

60 V  
 60 V  
 450 V  
 650 V

## Ordering data

No function display      Type  
 Order No.  
 Qty.

VSPC 1CL PW 24V

**8951510000**

1 ST

## Note



## VARITECTOR SPC

### VSPC 2SL - protection for two binary signals

- Optional monitoring function with status indicator and alert function
- Pluggable arrester (impedance-neutral plugging/unplugging without interruption)
- Can be tested with the V-TEST testing device
- Version with floating-earth PE connection for avoiding voltage potential differences
- Usable in accordance with installations standard IEC 62305
- Tested in accordance with IEC 61643-21:08 D1,C1,C2,C3
- Integrated PE foot, safely discharges up to 20 kA (8/20  $\mu$ s) and 2.5 kA (10/350  $\mu$ s) to PE



## B

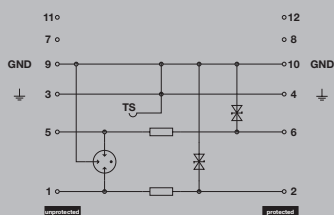

Complete module, direct earthing

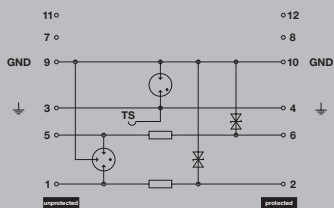

Complete module, indirect earthing

### Technical data

Dielectric strength at FG against PE	$\geq 500$ V
Volume resistance	4.7 $\Omega$
Overload - failure mode	Modus 2
Requirements category acc. to IEC 61643-21	C1, C2, C3, D1
Surge current-carrying capacity C1	< 1 kA 8/20 $\mu$ s
Surge current-carrying capacity C2	5 kA 8/20 $\mu$ s
Surge current-carrying capacity C3	100 A 10/1000 $\mu$ s
Surge current-carrying capacity D1	2.5 kA 10/350 $\mu$ s
Discharge current $I_t$ (8/20 $\mu$ s) wire-wire/wire-PE/GND-PE	2.5 kA / 2.5 kA / 2.5 kA
Discharge $I_{max}$ (8/20 $\mu$ s) wire-wire/wire-PE/GND-PE	10 kA / 10 kA / 10 kA
Lightning test $I_{imp}$ (10/350 $\mu$ s) wire-wire/wire-PE/GND-PE	2.5 kA / 2.5 kA / 2.5 kA
Type of connection	Pluggable in VSPC BASE
Storage temperature	-40 °C...+80 °C
Ambient temperature (operational)	-40 °C...+70 °C
Protection degree	IP 20
<b>Failure probability</b>	
Ages	43
MTTF	2665
SIL in compliance with IEC 61508	2
<b>Approvals</b>	
Approvals	CE; GOSTME25; OEVE; TUEV; UL
Standards	IEC 61643-21

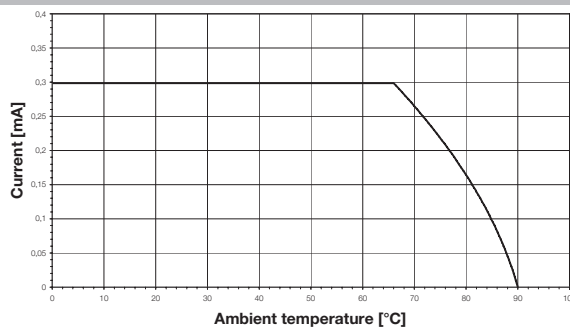

Dimensions of complete module (arrester + base element)	no remote sig. contact
Height x width x depth	mm 90 / 17.8 / 69
<b>Note</b>	The associated VSPC base element should be ordered with this. The dimension information provided refers to the complete module.

### Base elements / base to arresters



### Ordering data for base

Description	Type	Qty.	Order No.
Base element, direct earthing	VSPC BASE 2SL	1	8924720000
Base element, indirect earthing / floating earth FG	VSPC BASE 2SL FG	1	8924280000

**Note** Technical data can be found at the end of the VARITECTOR SPC section.

VSPC 2SL - arrester / plug-in components



Ordering data

Rated voltage (AC)
Rated voltage (DC)
Max. continuous voltage, U <sub>c</sub> (AC)
Max. continuous voltage, U <sub>c</sub> (DC)
Rated current
Input attenuation
Pulse-reset capacity
Residual voltage, U <sub>r</sub> , typical
<b>Protection level</b>
Wire-wire 1 kV/μs, typically
Wire-wire 8/20 μs, typically
Wire-PE 1kV/μs, typically
Wire-PE 8/20 μs, typically

	VSPC 2SL 5 V DC	VSPC 2SL 12 V DC	VSPC 2SL 12 V AC	VSPC 2SL 24 V DC
Rated voltage (AC)			12 V	
Rated voltage (DC)	5 V	12 V	16 V	24 V
Max. continuous voltage, U <sub>c</sub> (AC)			13.2 V	
Max. continuous voltage, U <sub>c</sub> (DC)	6.4 V	15 V	18.5 V	28 V
Rated current	300 mA	300 mA	300 mA	300 mA
Input attenuation	1.2 MHz	2.5 MHz	3.2 MHz	2.7 MHz
Pulse-reset capacity	20 ms	20 ms	20 ms	30 ms
Residual voltage, U <sub>r</sub> , typical	25 V	50 V	50 V	60 V
<b>Protection level</b>				
Wire-wire 1 kV/μs, typically	25 V	45 V	55 V	80 V
Wire-wire 8/20 μs, typically	25 V	45 V	55 V	80 V
Wire-PE 1kV/μs, typically	12 V	25 V	30 V	40 V
Wire-PE 8/20 μs, typically	25 V	50 V	50 V	60 V

<b>Ordering data</b>
No function display
Type
Order No.
Qty.
<b>Note</b>

	VSPC 2SL 5VDC	VSPC 2SL 12VDC	VSPC 2SL 12VAC	VSPC 2SL 24VDC
Type				
Order No.	<b>8924210000</b>	<b>8924230000</b>	<b>8924250000</b>	<b>8924330000</b>
Qty.	1 ST	1 ST	1 ST	1 ST

Ordering data

Rated voltage (AC)
Rated voltage (DC)
Max. continuous voltage, U <sub>c</sub> (AC)
Max. continuous voltage, U <sub>c</sub> (DC)
Rated current
Input attenuation
Pulse-reset capacity
Residual voltage, U <sub>r</sub> , typical
<b>Protection level</b>
Wire-wire 1 kV/μs, typically
Wire-wire 8/20 μs, typically
Wire-PE 1kV/μs, typically
Wire-PE 8/20 μs, typically

	VSPC 2SL 24 V AC	VSPC 2SL 48 V AC	VSPC 2SL 60 V AC
Rated voltage (AC)	24 V	48 V	60 V
Rated voltage (DC)	34 V	68 V	85 V
Max. continuous voltage, U <sub>c</sub> (AC)	28 V	60 V	72 V
Max. continuous voltage, U <sub>c</sub> (DC)	40 V	85 V	102 V
Rated current	300 mA	250 mA	200 mA
Input attenuation	5.5 MHz	8.7 MHz	13.6 MHz
Pulse-reset capacity	60 ms	60 ms	60 ms
Residual voltage, U <sub>r</sub> , typical	60 V	125 V	165 V
<b>Protection level</b>			
Wire-wire 1 kV/μs, typically	110 V	210 V	280 V
Wire-wire 8/20 μs, typically	80 V	80 V	80 V
Wire-PE 1kV/μs, typically	60 V	85 V	100 V
Wire-PE 8/20 μs, typically	60 V	125 V	165 V

<b>Ordering data</b>
No function display
Type
Order No.
Qty.
<b>Note</b>

	VSPC 2SL 24VAC	VSPC 2SL 48VAC	VSPC 2SL 60VAC
Type			
Order No.	<b>8924350000</b>	<b>8924370000</b>	<b>8924390000</b>
Qty.	1 ST	1 ST	1 ST



## VARITECTOR SPC

### VSPC 2SL - protection for two binary signals with remote alert

- Optional monitoring function with status indicator and alert function
- Pluggable arrester (impedance-neutral plugging/unplugging without interruption)
- Can be tested with the V-TEST testing device
- Version with floating-earth PE connection for avoiding voltage potential differences
- Usable in accordance with installations standard IEC 62305
- Tested in accordance with IEC 61643-21:08 D1,C1,C2,C3
- Integrated PE foot, safely discharges up to 20 kA (8/20  $\mu$ s) and 2.5 kA (10/350  $\mu$ s) to PE



**B**

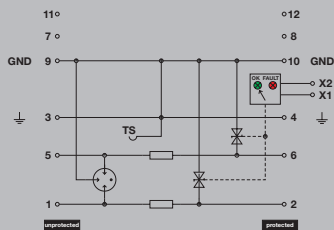

Complete module, direct earthing, with remote alert

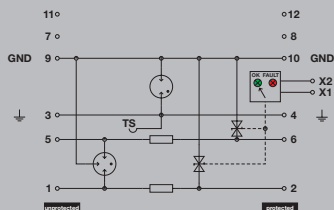

Complete module, indirect earthing, with remote alert

### Technical data

Dielectric strength at FG against PE	$\geq 500$ V
Volume resistance	4.7 $\Omega$
Overload - failure mode	Modus 2
Requirements category acc. to IEC 61643-21	C1, C2, C3, D1
Surge current-carrying capacity C1	< 1 kA 8/20 $\mu$ s
Surge current-carrying capacity C2	5 kA 8/20 $\mu$ s
Surge current-carrying capacity C3	100 A 10/1000 $\mu$ s
Surge current-carrying capacity D1	2.5 kA 10/350 $\mu$ s
Discharge current $I_t$ (8/20 $\mu$ s) wire-wire/wire-PE/GND-PE	2.5 kA / 2.5 kA / 2.5 kA
Discharge $I_{max}$ (8/20 $\mu$ s) wire-wire/wire-PE/GND-PE	10 kA / 10 kA / 10 kA
Lightning test $I_{imp}$ (10/350 $\mu$ s) wire-wire/wire-PE/GND-PE	2.5 kA / 2.5 kA / 2.5 kA
Type of connection	Pluggable in VSPC BASE
Storage temperature	-40 °C...+80 °C
Ambient temperature (operational)	-40 °C...+70 °C
Protection degree	IP 20
<b>Failure probability</b>	
Ages	43
MTTF	2665
SIL in compliance with IEC 61508	2
<b>Approvals</b>	
Approvals	CE; GOSTME25; OEVE; TUEV; UL
Standards	IEC 61643-21

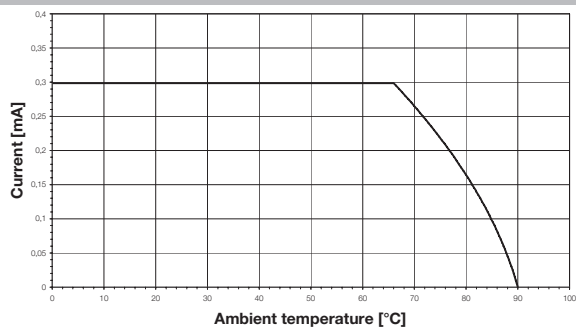

Dimensions of complete module (arrester + base element)	with remote signalling (R)
Height x width x depth	mm 98 / 17.8 / 69
<b>Note</b>	
The associated VSPC base element should be ordered with this. The dimension information provided refers to the complete module.	

### Base elements / base to arresters



### Ordering data for base

Description	Type	Qty.	Order No.
Base element, indirect earthing with remote contact	VSPC BASE 2SL FG R	1	8951780000
Base element, direct earthing with remote contact	VSPC BASE 2SL R	1	8951770000

**Note** Technical data can be found at the end of the VARITECTOR SPC section. Order with VSPC CONTROL UNIT.

**VSPC 2SL - arrester / plug-in elements with remote alert**



Ordering data	VSPC 2SL 5 V DC R	VSPC 2SL 12 V DC R	VSPC 2SL 24 V DC R	VSPC 2SL 24 V AC R
Rated voltage (AC)				24 V
Rated voltage (DC)	5 V	12 V	24 V	34 V
Max. continuous voltage, U <sub>c</sub> (AC)				28 V
Max. continuous voltage, U <sub>c</sub> (DC)	6.4 V	15 V	28 V	40 V
Rated current	300 mA	300 mA	300 mA	300 mA
Signalling contact	U <sub>N</sub> 250 V AC 0.1 A 1CO at VSPC R with VSPC CONTROL UNIT	U <sub>N</sub> 250 V AC 0.1 A 1CO at VSPC R with VSPC CONTROL UNIT	U <sub>N</sub> 250 V AC 0.1 A 1CO at VSPC R with VSPC CONTROL UNIT	U <sub>N</sub> 250 V AC 0.1 A 1CO at VSPC R with VSPC CONTROL UNIT
Optical function display	green = OK; red = arrester is defective - replace	green = OK; red = arrester is defective - replace	green = OK; red = arrester is defective - replace	green = OK; red = arrester is defective - replace
Input attenuation	1.2 MHz	2.5 MHz	2.7 MHz	5.5 MHz
Pulse-reset capacity	20 ms	20 ms	30 ms	60 ms
Residual voltage, U <sub>r</sub> , typical	25 V	50 V	60 V	60 V
<b>Protection level</b>				
Wire-wire 1 kV/μs, typically	25 V	45 V	80 V	110 V
Wire-wire 8/20 μs, typically	25 V	45 V	80 V	80 V
Wire-PE 1 kV/μs, typically	12 V	25 V	40 V	60 V
Wire-PE 8/20 μs, typically	25 V	50 V	60 V	60 V
<b>Ordering data</b>				
With functional display	Type	Type	Type	Type
	VSPC 2SL 5VDC R	VSPC 2SL 12VDC R	VSPC 2SL 24VDC R	VSPC 2SL 24VAC R
	<b>8951610000</b>	<b>8951620000</b>	<b>8951630000</b>	<b>8951640000</b>
	Qty.	Qty.	Qty.	Qty.
	1 ST	1 ST	1 ST	1 ST
<b>Note</b>				



## VARITECTOR SPC

### VSPC 4SL - protection for four binary signals

- Optional monitoring function with status indicator and alert function
- Pluggable arrester (impedance-neutral plugging/unplugging without interruption)
- Can be tested with the V-TEST testing device
- Version with floating-earth PE connection for avoiding voltage potential differences
- Space-saving design for 4 binary signals with optional alert function and no extra space required
- Usable in accordance with installation standard IEC 62305
- Tested in accordance with IEC 61643-21:08 D1, C1, C2, C3
- Integrated PE foot, safely discharges up to 20 kA (8/20 μs) and 2.5 kA (10/350 μs) to PE



#### Technical data

Dielectric strength at FG against PE	≥ 500 V
Volume resistance	4.7 Ω
Overload - failure mode	Modus 2
Requirements category acc. to IEC 61643-21	C1, C2, C3, D1
Surge current-carrying capacity C1	< 1 kA 8/20 μs
Surge current-carrying capacity C2	5 kA 8/20 μs
Surge current-carrying capacity C3	100 A 10/1000 μs
Surge current-carrying capacity D1	2.5 kA 10/350 μs
Discharge current $I_n$ (8/20 μs) wire-wire/wire-PE/GND-PE	2.5 kA / 2.5 kA / 2.5 kA
Discharge $I_{max}$ (8/20 μs) wire-wire/wire-PE/GND-PE	10 kA / 10 kA / 10 kA
Lightning test $I_{imp}$ (10/350 μs) wire-wire/wire-PE/GND-PE	2.5 kA / 2.5 kA / 2.5 kA
Type of connection	Pluggable in VSPC BASE
Storage temperature	-40 °C...+80 °C
Ambient temperature (operational)	-40 °C...+70 °C
Protection degree	IP 20
<b>Failure probability</b>	
Ages	43
MTTF	2665
SIL in compliance with IEC 61508	2
<b>Approvals</b>	
Approvals	CE; GOSTME25; OEVE; TUEV; UL
Standards	IEC 61643-21

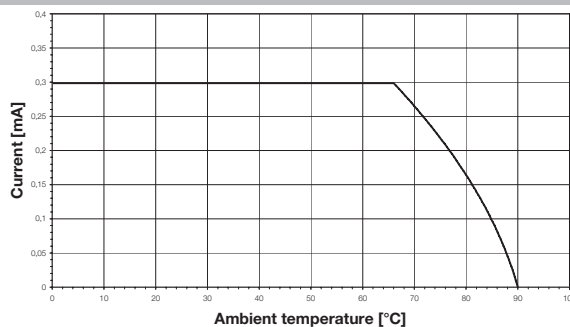
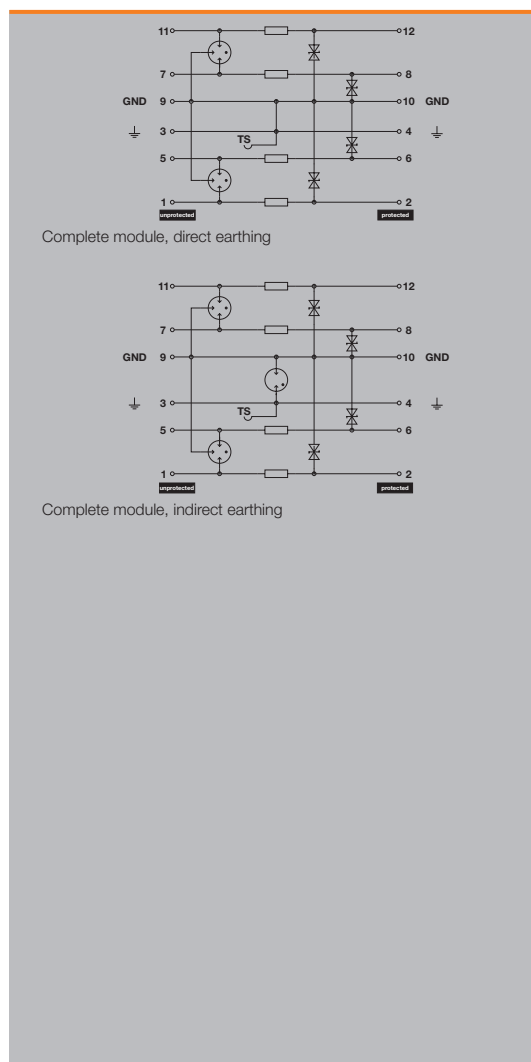

Dimensions of complete module (arrester + base element)	no remote sig. contact
Height x width x depth	mm 90 / 17.8 / 69
<b>Note</b>	
The associated VSPC base element should be ordered with this. The dimension information provided refers to the complete module.	

#### Base elements / base to arresters



#### Ordering data for base

Description	Type	Qty.	Order No.
Base element, direct earthing	VSPC BASE 4SL	1	8924700000
Base element, indirect earthing / floating earth FG	VSPC BASE 4SL FG	1	8924260000

<b>Note</b>	Technical data can be found at the end of the VARITECTOR SPC section.
-------------	---

VSPC 4SL - arrester / plug-in elements



Ordering data

	VSPC 4SL 5 V DC	VSPC 4SL 12 V DC	VSPC 4SL 12 V AC	VSPC 4SL 24 V DC
Rated voltage (AC)			12 V	
Rated voltage (DC)	5 V	12 V	16 V	24 V
Max. continuous voltage, U <sub>c</sub> (AC)			13.2 V	
Max. continuous voltage, U <sub>c</sub> (DC)	6.4 V	15 V	18 V	28 V
Rated current	300 mA	300 mA	300 mA	300 mA
Input attenuation	1.2 MHz	2.5 MHz	3.2 MHz	4 MHz
Pulse-reset capacity	20 ms	20 ms	20 ms	30 ms
Residual voltage, U <sub>r</sub> , typical	25 V	35 V	50 V	60 V
<b>Protection level</b>				
Wire-wire 1 kV/μs, typically	25 V	45 V	55 V	80 V
Wire-wire 8/20 μs, typically	25 V	45 V	55 V	80 V
Wire-PE 1kV/μs, typically	12 V	25 V	30 V	40 V
Wire-PE 8/20 μs, typically	25 V	50 V	50 V	60 V

Ordering data		VSPC 4SL 5VDC	VSPC 4SL 12VDC	VSPC 4SL 12VAC	VSPC 4SL 24VDC
No function display	Type	VSPC 4SL 5VDC	VSPC 4SL 12VDC	VSPC 4SL 12VAC	VSPC 4SL 24VDC
	Order No.	<b>8924200000</b>	<b>8924220000</b>	<b>8924240000</b>	<b>8924320000</b>
	Qty.	1 ST	1 ST	1 ST	1 ST
<b>Note</b>					

Ordering data

	VSPC 4SL 24 V AC	VSPC 4SL 48 V AC	VSPC 4SL 60 V AC
Rated voltage (AC)	24 V	48 V	60 V
Rated voltage (DC)	34 V	68 V	85 V
Max. continuous voltage, U <sub>c</sub> (AC)	28 V	60 V	72 V
Max. continuous voltage, U <sub>c</sub> (DC)	39 V	85 V	101 V
Rated current	300 mA	250 mA	200 mA
Input attenuation	2.7 MHz	8.7 MHz	13.6 MHz
Pulse-reset capacity	40 ms	60 ms	60 ms
Residual voltage, U <sub>r</sub> , typical	60 V	125 V	165 V
<b>Protection level</b>			
Wire-wire 1 kV/μs, typically	110 V	210 V	280 V
Wire-wire 8/20 μs, typically	80 V	80 V	80 V
Wire-PE 1kV/μs, typically	60 V	85 V	110 V
Wire-PE 8/20 μs, typically	60 V	125 V	165 V

Ordering data		VSPC 4SL 24VAC	VSPC 4SL 48VAC	VSPC 4SL 60VAC
No function display	Type	VSPC 4SL 24VAC	VSPC 4SL 48VAC	VSPC 4SL 60VAC
	Order No.	<b>8924340000</b>	<b>8924360000</b>	<b>8924380000</b>
	Qty.	1 ST	1 ST	1 ST
<b>Note</b>				





## VARITECTOR SPC

### VSPC 4SL - protection for four binary signals with remote alert

- Optional monitoring function with status indicator and alert function
- Pluggable arrester (impedance-neutral plugging/unplugging without interruption)
- Can be tested with the V-TEST testing device
- Version with floating-earth PE connection for avoiding voltage potential differences
- Space-saving design for 4 binary signals with optional alert function and no extra space required
- Usable in accordance with installation standard IEC 62305
- Tested in accordance with IEC 61643-21:08 D1, C1, C2, C3
- Integrated PE foot, safely discharges up to 20 kA (8/20 μs) and 2.5 kA (10/350 μs) to PE



#### Technical data

Dielectric strength at FG against PE	≥ 500 V
Volume resistance	4.7 Ω
Overload - failure mode	Modus 2
Requirements category acc. to IEC 61643-21	C1, C2, C3, D1
Surge current-carrying capacity C1	< 1 kA 8/20 μs
Surge current-carrying capacity C2	5 kA 8/20 μs
Surge current-carrying capacity C3	100 A 10/1000 μs
Surge current-carrying capacity D1	2.5 kA 10/350 μs
Discharge current I <sub>1</sub> (8/20 μs) wire-wire/wire-PE/GND-PE	2.5 kA / 2.5 kA / 2.5 kA
Discharge I <sub>max</sub> (8/20 μs) wire-wire/wire-PE/GND-PE	10 kA / 10 kA / 10 kA
Lightning test I <sub>imp</sub> (10/350 μs) wire-wire/wire-PE/GND-PE	2.5 kA / 2.5 kA / 2.5 kA
Type of connection	Pluggable in VSPC BASE
Storage temperature	-40 °C...+80 °C
Ambient temperature (operational)	-40 °C...+70 °C
Protection degree	IP 20
<b>Failure probability</b>	
Ages	43
MTTF	2665
SIL in compliance with IEC 61508	2
<b>Approvals</b>	
Approvals	CE; GOSTME25; OEVE; TUEV; UL
Standards	IEC 61643-21

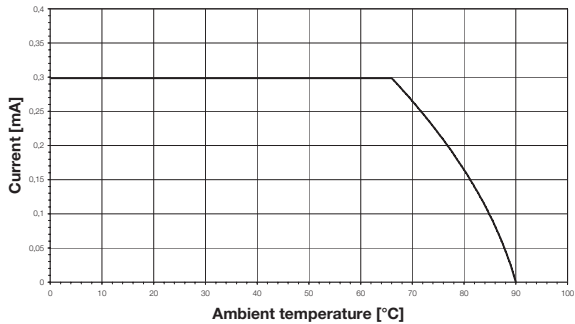
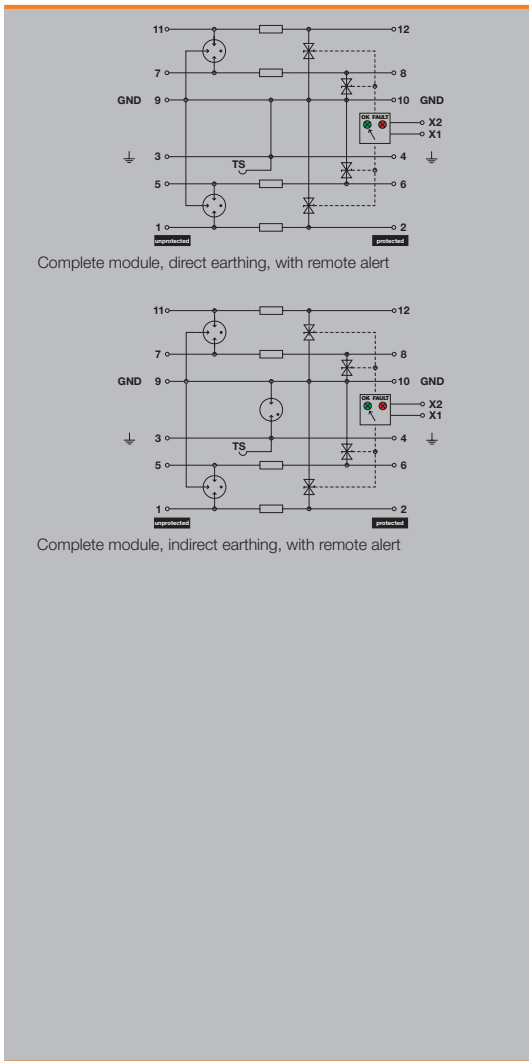

Dimensions of complete module (arrester + base element)	with remote signalling (R)
Height x width x depth	mm 98 / 17.8 / 69
<b>Note</b>	The associated VSPC base element should be ordered with this. The dimension information provided refers to the complete module.

#### Base elements / base to arresters



#### Ordering data for base

Description	Type	Qty.	Order No.
Base element, indirect earthing with remote contact	VSPC BASE 4SL FG R	1	8951760000
Base element, direct earthing with remote contact	VSPC BASE 4SL R	1	8951750000

**Note** Technical data can be found at the end of the VARITECTOR SPC section. Order with VSPC CONTROL UNIT.

**VSPC 4SL - arrester / plug-in elements with remote alert**



Ordering data	VSPC 4SL 5 V DC R	VSPC 4SL 12 V DC R	VSPC 4SL 24 V DC R	VSPC 4SL 24 V AC R
Rated voltage (AC)				24 V
Rated voltage (DC)	5 V	12 V	24 V	34 V
Max. continuous voltage, U <sub>c</sub> (AC)				28 V
Max. continuous voltage, U <sub>c</sub> (DC)	6.4 V	15 V	28 V	39 V
Rated current	300 mA	300 mA	300 mA	300 mA
Signalling contact	U <sub>N</sub> 250 V AC 0.1 A 1CO at VSPC R with VSPC CONTROL UNIT	U <sub>N</sub> 250 V AC 0.1 A 1CO at VSPC R with VSPC CONTROL UNIT	U <sub>N</sub> 250 V AC 0.1 A 1CO at VSPC R with VSPC CONTROL UNIT	U <sub>N</sub> 250 V AC 0.1 A 1CO at VSPC R with VSPC CONTROL UNIT
Optical function display	green = OK; red = arrester is defective - replace	green = OK; red = arrester is defective - replace	green = OK; red = arrester is defective - replace	green = OK; red = arrester is defective - replace
Input attenuation	1.2 MHz	2.5 MHz	4 MHz	2.7 MHz
Pulse-reset capacity	20 ms	20 ms	30 ms	40 ms
Residual voltage, U <sub>r</sub> , typical	25 V	35 V	60 V	60 V
<b>Protection level</b>				
Wire-wire 1 kV/μs, typically	25 V	45 V	80 V	110 V
Wire-wire 8/20 μs, typically	25 V	45 V	80 V	80 V
Wire-PE 1 kV/μs, typically	12 V	25 V	40 V	60 V
Wire-PE 8/20 μs, typically	25 V	50 V	60 V	60 V
<b>Ordering data</b>				
With functional display	Type	Type	Type	Type
	VSPC 4SL 5VDC R	VSPC 4SL 12VDC R	VSPC 4SL 24VDC R	VSPC 4SL 24VAC R
	<b>8951570000</b>	<b>8951580000</b>	<b>8951590000</b>	<b>8951600000</b>
	Order No.	Order No.	Order No.	Order No.
	1 ST	1 ST	1 ST	1 ST
	Qty.	Qty.	Qty.	Qty.
<b>Note</b>				

## VARITECTOR SPC

### VSPC 4 SL WIRE - protection for 3/4-wire signals

- Protection of measuring bridge signals
- Pluggable arrester (impedance-neutral plugging/unplugging without interruption)
- Can be tested with the V-TEST testing device
- Version with floating-earth PE connection for avoiding voltage potential differences
- Space-saving design for 4 binary signals with optional alert function and no extra space required
- Usable in accordance with installations standard IEC 62305
- Tested in accordance with IEC 61643-21:08 D1,C1,C2,C3
- Integrated PE foot, safely discharges up to 20 kA (8/20 μs) and 2.5 kA (10/350 μs) to PE



#### Technical data

Dielectric strength at FG against PE	≥ 500 V
Volume resistance	0.20 Ω
Overload - failure mode	Modus 2
Requirements category acc. to IEC 61643-21	C1, C2, C3, D1
Surge current-carrying capacity C1	< 1 kA 8/20 μs
Surge current-carrying capacity C2	5 kA 8/20 μs
Surge current-carrying capacity C3	100 A 10/1000 μs
Surge current-carrying capacity D1	2.5 kA 10/350 μs
Discharge current I <sub>1</sub> (8/20 μs) wire-wire/wire-PE/GND-PE	2.5 kA / 2.5 kA / 2.5 kA
Discharge I <sub>max</sub> (8/20 μs) wire-wire/wire-PE/GND-PE	10 kA / 10 kA / 10 kA
Lightning test I <sub>imp</sub> (10/350 μs) wire-wire/wire-PE/GND-PE	2.5 kA / 2.5 kA / 2.5 kA
Type of connection	Pluggable in VSPC BASE
Storage temperature	-40 °C...+80 °C
Ambient temperature (operational)	-40 °C...+70 °C
Protection degree	IP 20
<b>Failure probability</b>	
Ages	43
MTTF	2655
SIL in compliance with IEC 61508	3
<b>Approvals</b>	
Approvals	CE; GOSTME25; OEVE; TUEV; UL
Standards	IEC 61643-21

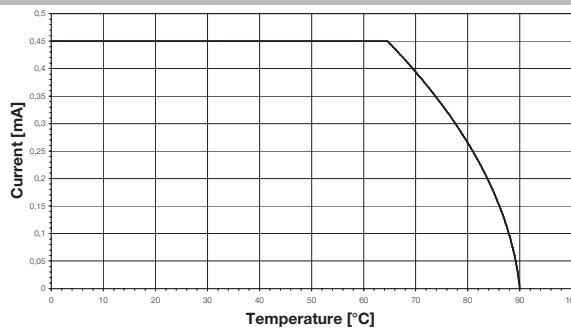
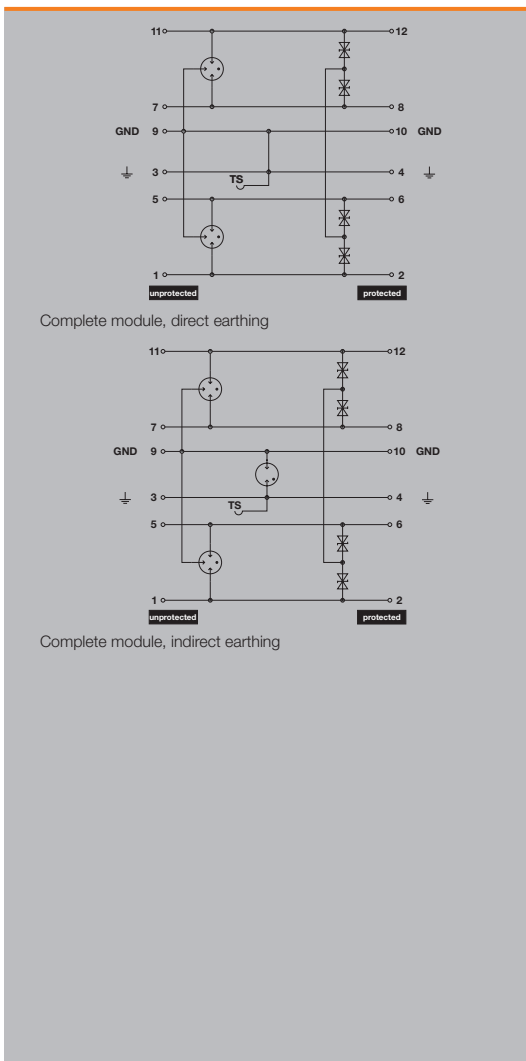

<b>Dimensions of complete module (arrester + base element)</b>	<b>no remote sig. contact</b>
Height x width x depth	mm 90 / 17.8 / 69
<b>Note</b>	The associated VSPC base element should be ordered with this. The dimension information provided refers to the complete module.

#### Base elements / base to arresters



#### Ordering data for base

Description	Type	Qty.	Order No.
Base element, direct earthing	VSPC BASE 2/4CH	1	8924740000
Base element, indirect earthing / floating earth FG	VSPC BASE 2/4CH FG	1	8924300000

**Note** Technical data can be found at the end of the VARITECTOR SPC section. Order with VSPC CONTROL UNIT.

VSPC 4SL WIRE - arrester / plug-in components



Ordering data

	VSPC 3/4 WIRE 5 V DC	VSPC 3/4 WIRE 24 V DC
Rated voltage (AC)		
Rated voltage (DC)	3 V	24 V
Max. continuous voltage, U <sub>c</sub> (AC)		
Max. continuous voltage, U <sub>c</sub> (DC)	6.4 V	28 V
Rated current	450 mA	450 mA
Signalling contact	No	No
Optical function display	No	No
Capacitance	2.3 nF	935 pF
Pulse-reset capacity	≤ 20 ms	≤ 30 ms
Residual voltage, U <sub>r</sub> , typical	800 V	800 V
<b>Protection level</b>		
Wire-wire 1 kV/μs, typically	35 V	50 V
Wire-wire 8/20 μs, typically	35 V	50 V
Wire-PE 1kV/μs, typically	250 V	270 V
Wire-PE 8/20 μs, typically	800 V	800 V

Ordering data			
No function display	Type	VSPC 3/4WIRE 5VDC	VSPC 3/4WIRE 24VDC
	Order No.	<b>8924540000</b>	<b>8924550000</b>
	Qty.	1 ST	1 ST
<b>Note</b>			



## VARITECTOR SPC

### VSPC GDT - with sparkover gap (GDT)

- Pluggable arrester (impedance-neutral plugging/unplugging without interruption)
- Can be tested with the V-TEST testing device
- Version with floating-earth PE connection for avoiding voltage potential differences
- Tested in accordance with IEC 61643-21:08
- Integrated PE foot, safely discharges up to 20 kA (8/20  $\mu$ s) and 2.5 kA (10/350  $\mu$ s) to PE



B

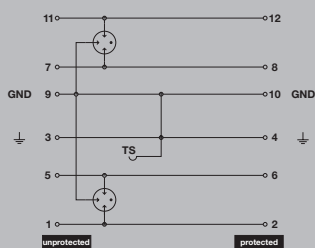

Complete module, direct earthing

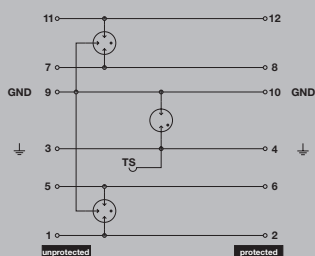

Complete module, indirect earthing

### Technical data

Dielectric strength at FG against PE	$\geq 500$ V
Volume resistance	0.20 $\Omega$
Overload - failure mode	Modus 2
Requirements category acc. to IEC 61643-21	C1, C2, C3, D1
Surge current-carrying capacity C1	< 1 kA 8/20 $\mu$ s
Surge current-carrying capacity C2	5 kA 8/20 $\mu$ s
Surge current-carrying capacity C3	100 A 10/1000 $\mu$ s
Surge current-carrying capacity D1	2.5 kA 10/350 $\mu$ s
Discharge current $I_d$ (8/20 $\mu$ s) wire-wire/wire-PE/GND-PE	2 x 2.5 kA / 2.5 kA / 2.5 kA
Discharge $I_{max}$ (8/20 $\mu$ s) wire-wire/wire-PE/GND-PE	2 x 10 kA / / 10 kA
Lightning test $I_{imp}$ (10/350 $\mu$ s) wire-wire/wire-PE/GND-PE	2 x 0.2 kA / / 0.2 kA
Type of connection	Pluggable in VSPC BASE
Storage temperature	-40 °C...+80 °C
Ambient temperature (operational)	-40 °C...+70 °C
Protection degree	IP 20
<b>Failure probability</b>	
Ages	11
MTTF	10378
SIL in compliance with IEC 61508	3
<b>Approvals</b>	
Approvals	CE; GOSTME25; TUEV; UL
Standards	According to IEC61643-21

Dimensions of complete module (arrester + base element)	no remote sig. contact
Height x width x depth	mm 90 / 17.8 / 69
<b>Note</b>	The associated VSPC base element should be ordered with this. The dimension information provided refers to the complete module.

### Base elements / base to arresters



### Ordering data for base

Description	Type	Qty.	Order No.
Base element, direct earthing	VSPC BASE 2/4CH	1	8924740000
Base element, indirect earthing / floating earth FG	VSPC BASE 2/4CH FG	1	8924300000

<b>Note</b>	Technical data can be found at the end of the VARITECTOR SPC section. Order with VSPC CONTROL UNIT.
-------------	---

VSPC GDT - arrester / plug-in components



Ordering data

	VSPC GDT 2CH 90 V	VSPC GDT 2CH 150 V AC/230 V DC
Rated voltage (AC)	48 V	110 V
Rated voltage (DC)	68 V	150 V
Max. continuous voltage, U <sub>c</sub> (AC)	50 V	125 V
Max. continuous voltage, U <sub>c</sub> (DC)	72 V	180 V
Rated current	2 A	2 A
Signalling contact	No	No
Optical function display	No	No
Capacitance	9.37 pF	7.45 pF
Residual voltage, U <sub>r</sub> typical	1000 V	800 V
<b>Protection level</b>		
Wire-wire 1 kV/μs, typically	650 V	450 V
Wire-wire 8/20 μs, typically	1000 V	800 V
Wire-PE 1kV/μs, typically	650 V	800 V
Wire-PE 8/20 μs, typically	950 V	800 V

Ordering data		
No function display	Type	VSPC GDT 2CH 90V
	Order No.	<b>8924570000</b>
	Qty.	1 ST
<b>Note</b>		The 90 V gas discharge tube has a tolerance of +/- 20%.
		VSPC GDT 2CH 150Vac/230Vdc
	Order No.	<b>8924590000</b>
	Qty.	1 ST
<b>Note</b>		The 230 V gas discharge tube has a tolerance of +/- 20%.

B



## VARITECTOR SPC

### VSPC MOV - protection with varistor

- Pluggable arrester (impedance-neutral plugging/unplugging without interruption)
- Can be tested with the V-TEST testing device
- Optional monitoring function with status display and alert functions for MOV components
- Version with floating-earth PE connection for avoiding voltage potential differences
- Tested in accordance with IEC 61643-21:08
- Integrated PE foot, safely discharges up to 20 kA (8/20  $\mu$ s) and 2.5 kA (10/350  $\mu$ s) to PE



B

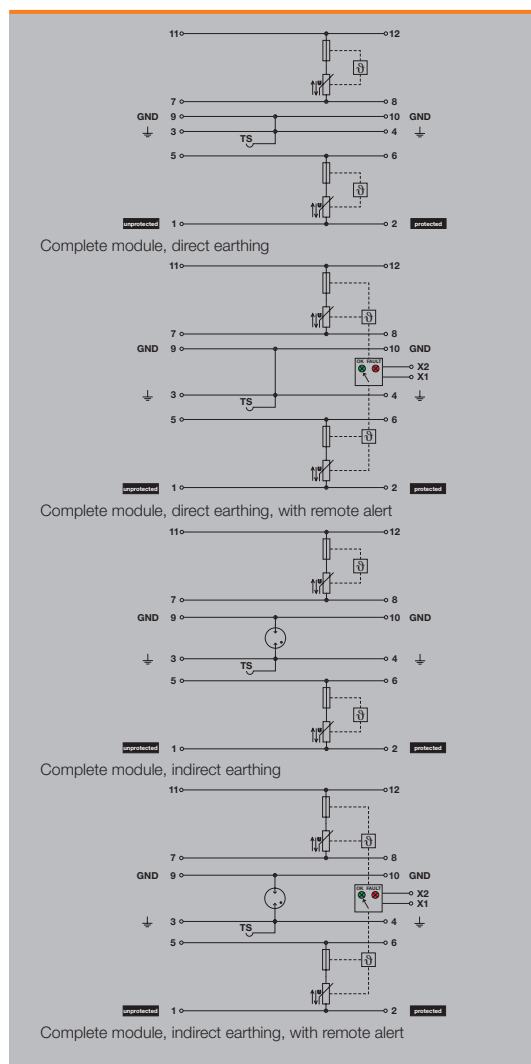

### Technical data

Dielectric strength at FG against PE	$\geq 500$ V
Volume resistance	0.20 $\Omega$
Overload - failure mode	Mode 1
Requirements category acc. to IEC 61643-21	C1, C2, C3, D1
Surge current-carrying capacity C1	< 1 kA 8/20 $\mu$ s
Surge current-carrying capacity C2	1.5 kA 8/20 $\mu$ s
Surge current-carrying capacity C3	100 A 10/1000 $\mu$ s
Surge current-carrying capacity D1	0.5 kA 10/350 $\mu$ s
Discharge current $I_d$ (8/20 $\mu$ s) wire-wire/wire-PE/GND-PE	0.2 kA / 2.5 kA / 0.5 kA
Discharge $I_{max}$ (8/20 $\mu$ s) wire-wire/wire-PE/GND-PE	1.5 kA / / 1.5 kA
Lightning test $I_{imp}$ (10/350 $\mu$ s) wire-wire/wire-PE/GND-PE	0.2 kA / / 0.5 kA
Type of connection	Pluggable in VSPC BASE
Storage temperature	-40 °C...+80 °C
Ambient temperature (operational)	-40 °C...+70 °C
Protection degree	IP 20
<b>Failure probability</b>	
Ages	26
MTTF	4391
SIL in compliance with IEC 61508	3
<b>Approvals</b>	
Approvals	CE, GOSTME25, OEVE, TUEV, UL
Standards	IEC 61643-21

<b>Dimensions of complete module (arrester + base element)</b>	<b>no remote sig. contact</b>
Height x width x depth	mm 90 / 17.8 / 69
<b>Note</b>	The associated VSPC base element should be ordered with this. The dimension information provided refers to the complete module.

### Base elements / base to arresters



### Ordering data for base

Description	Type	Qty.	Order No.
Base element, indirect earthing with remote contact	VSPC BASE 2/4CH FG R	1	8951800000
Base element, direct earthing with remote contact	VSPC BASE 2/4CH R	1	8951790000
Base element, direct earthing	VSPC BASE 2/4CH	1	8924740000
Base element, indirect earthing / floating earth FG	VSPC BASE 2/4CH FG	1	8924300000

**Note** Technical data can be found at the end of the VARITECTOR SPC section. Order with VSPC CONTROL UNIT.

VSPC MOV - arrester / plug-in components



Ordering data	VSPC MOV 2CH 24 V	VSPC MOV 2CH 230 V	VSPC MOV 2CH 24 V R	VSPC MOV 2CH 230 V R
Rated voltage (AC)	24 V	230 V	24 V	230 V
Rated voltage (DC)	24 V	230 V	24 V	230 V
Max. continuous voltage, U <sub>c</sub> (AC)	30 V	275 V	30 V	275 V
Max. continuous voltage, U <sub>c</sub> (DC)	38 V	350 V	38 V	350 V
Rated current	10 A	10 A	10 A	10 A
Signalling contact	No	No	U <sub>n</sub> 250 V AC 0.1 A 1CO at VSPC R with VSPC CONTROL UNIT	U <sub>n</sub> 250 V AC 0.1 A 1CO at VSPC R with VSPC CONTROL UNIT
Optical function display	No	No	green = OK; red = arrester is defective - replace	green = OK; red = arrester is defective - replace
Capacitance	14.5 nF	720 pF	14.5 nF	720 pF
Residual voltage, U <sub>r</sub> typical	200 V	850 V	200 V	850 V
<b>Protection level</b>				
Wire-wire 1 kV/μs, typically	80 V	600 V	80 V	600 V
Wire-wire 8/20 μs, typically	95 V	700 V	95 V	700 V
Wire-PE 1kV/μs, typically				
Wire-PE 8/20 μs, typically				
<b>Ordering data</b>	<b>Without functional display</b>	<b>Without functional display</b>	<b>With functional display</b>	<b>With functional display</b>
Type	VSPC MOV 2CH 24V	VSPC MOV 2CH 230V	VSPC MOV 2CH 24V R	VSPC MOV 2CH 230V R
Order No.	<b>8924600000</b>	<b>8924610000</b>	<b>8951650000</b>	<b>8951660000</b>
Qty.	1 ST	1 ST	1 ST	1 ST
<b>Note</b>				



## VARITECTOR SPC

### VSPC TAZ - protection with transport diode

- Pluggable arrester (impedance-neutral plugging/unplugging without interruption)
- Can be tested with the V-TEST testing device
- Optional monitoring function with status display and alert functions for MOV components
- Lower residual voltage
- Version with floating-earth PE connection for avoiding voltage potential differences
- Tested in accordance with IEC 61643-21:08
- Integrated PE foot, safely discharges up to 20 kA (8/20 μs) and 2.5 kA (10/350 μs) to PE



### Technical data

Dielectric strength at FG against PE	≥ 500 V
Volume resistance	0.20 Ω
Overload - failure mode	Mode 1
Requirements category acc. to IEC 61643-21	C3
Surge current-carrying capacity C1	
Surge current-carrying capacity C2	
Surge current-carrying capacity C3	20 A 10/1000 μs
Surge current-carrying capacity D1	
Discharge current I <sub>1</sub> (8/20 μs) wire-wire/wire-PE/GND-PE	0.05 kA / /
Discharge I <sub>max</sub> (8/20 μs) wire-wire/wire-PE/GND-PE	0,1 kA / /
Lightning test I <sub>imp</sub> (10/350 μs) wire-wire/wire-PE/GND-PE	
Type of connection	Pluggable in VSPC BASE
Storage temperature	-40 °C...+80 °C
Ambient temperature (operational)	-40 °C...+70 °C
Protection degree	IP 20
<b>Failure probability</b>	
Ages	32
MTTF	3567
SIL in compliance with IEC 61508	3
<b>Approvals</b>	
Approvals	CE; GOSTME25; OEVE; TUEV; UL
Standards	According to IEC61643-21

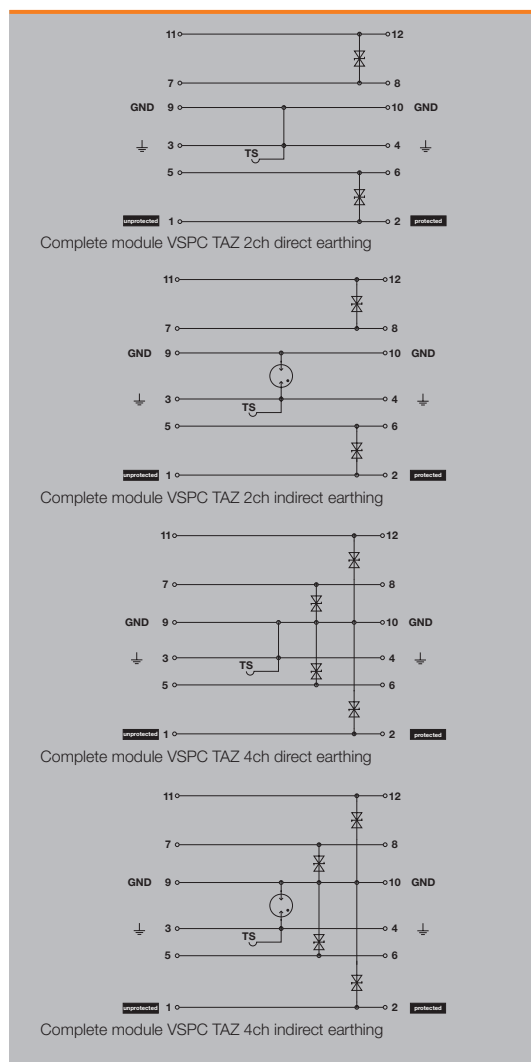

Dimensions of complete module (arrester + base element)	no remote sig. contact	
Height x width x depth	mm	90 / 17.8 / 69
<b>Note</b>		
The associated VSPC base element should be ordered with this. The dimension information provided refers to the complete module.		

### Base elements / base to arresters



### Ordering data for base

Description	Type	Qty.	Order No.
Base element, direct earthing	VSPC BASE 2/4CH	1	8924740000
Base element, indirect earthing / floating earth FG	VSPC BASE 2/4CH FG	1	8924300000

<b>Note</b>	Technical data can be found at the end of the VARITECTOR SPC section. Order with VSPC CONTROL UNIT.
-------------	---

VSPC TAZ - arrester / plug-in components



Ordering data

	VSPC TAZ 2CH 24 V AC	VSPC TAZ 4CH 24 V
Rated voltage (AC)	24 V	24 V
Rated voltage (DC)	24 V	24 V
Max. continuous voltage, U <sub>c</sub> (AC)	28 V	28 V
Max. continuous voltage, U <sub>c</sub> (DC)	39 V	39 V
Rated current	10 A	10 A
Signalling contact	No	No
Optical function display	No	No
Capacitance	387 pF	680 pF
Residual voltage, U <sub>r</sub> typical	65 V	65 V
<b>Protection level</b>		
Wire-wire 1 kV/μs, typically	50 V	50 V
Wire-wire 8/20 μs, typically	55 V	55 V
Wire-PE 1kV/μs, typically	55 V	55 V
Wire-PE 8/20 μs, typically	65 V	65 V

Ordering data			
No function display	Type	VSPC TAZ 2CH 24V	VSPC TAZ 4CH 24V
	Order No.	<b>8924640000</b>	<b>8924650000</b>
	Qty.	1 ST	1 ST
<b>Note</b>			



## VARITECTOR SPC

### VSPC TELE UKO - protection for telephones

- Pluggable arrester (impedance-neutral plugging/unplugging without interruption)
- Can be tested with the V-TEST testing device
- Two-wire input interface -  $U_{ko}$
- Version with floating-earth PE connection for avoiding voltage potential differences
- Tested in accordance with IEC 61643-21:08
- Integrated PE foot, safely discharges up to 20 kA (8/20  $\mu$ s) and 2.5 kA (10/350  $\mu$ s) to PE



B

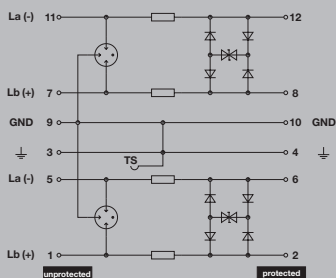

Complete module, direct earthing

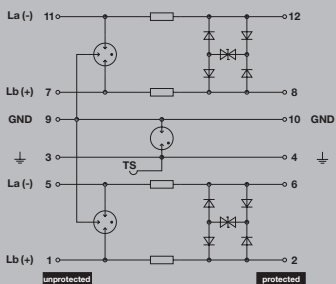

Complete module, indirect earthing

### Technical data

Dielectric strength at FG against PE	$\geq 500$ V
Volume resistance	2.20 $\Omega$
Overload - failure mode	Modus 2
Requirements category acc. to IEC 61643-21	C1, C2, C3, D1
Surge current-carrying capacity C1	< 1 kA 8/20 $\mu$ s
Surge current-carrying capacity C2	5 kA 8/20 $\mu$ s
Surge current-carrying capacity C3	100 A 10/1000 $\mu$ s
Surge current-carrying capacity D1	2.5 kA 10/350 $\mu$ s
Discharge current $I_t$ (8/20 $\mu$ s) wire-wire/wire-PE/GND-PE	2.5 kA / 2.5 kA / 2.5 kA
Discharge $I_{max}$ (8/20 $\mu$ s) wire-wire/wire-PE/GND-PE	10 kA / 2 x 10 kA / 10 kA
Lightning test $I_{imp}$ (10/350 $\mu$ s) wire-wire/wire-PE/GND-PE	0.2 kA / 2 x 0.2 kA / 0.2 kA
Type of connection	Pluggable in VSPC BASE
Storage temperature	-40 °C...+80 °C
Ambient temperature (operational)	-40 °C...+70 °C
Protection degree	IP 20
<b>Failure probability</b>	
Ages	49
MTTF	2330
SIL in compliance with IEC 61508	3
<b>Approvals</b>	
Approvals	CE; GOSTME25; TUEV; UL
Standards	According to IEC61643-21

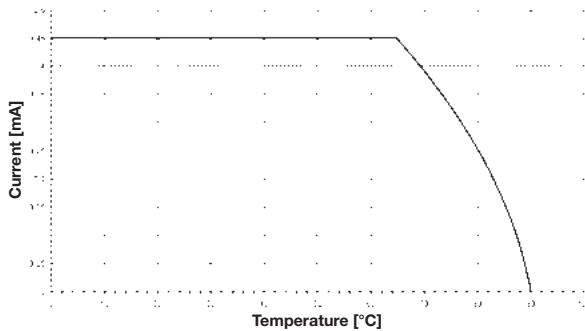

Dimensions of complete module (arrester + base element)	no remote sig. contact
Height x width x depth	mm 90 / 17.8 / 69
<b>Note</b>	Order the associated VSPC base element with this. The dimension information provided refers to the complete module.

### Base elements / base to arresters



### Ordering data for base

Description	Type	Qty.	Order No.
Base element, direct earthing	VSPC BASE 2CL	1	8924710000
Base element, indirect earthing / floating earth FG	VSPC BASE 2CL FG	1	8924270000

**Note** Technical data can be found at the end of the VARITECTOR SPC section.

## VSPC TELE UK0 - arrester/plug-in components



## Ordering data

Rated voltage (AC)
Rated voltage (DC)
Max. continuous voltage, U <sub>c</sub> (AC)
Max. continuous voltage, U <sub>c</sub> (DC)
Rated current
Signalling contact
Optical function display
Input attenuation
Pulse-reset capacity
Residual voltage, U <sub>r</sub> , typical

## VSPC TELE UK0 2 WIRE

127 V
120 V
130 V
180 V
450 mA
No
No
101.7 MHz
60 ms
800 V

## Protection level

Wire-wire 1 kV/μs, typically
Wire-wire 8/20 μs, typically
Wire-PE 1kV/μs, typically
Wire-PE 8/20 μs, typically

250 V
300 V
450 V
800 V

## Ordering data

No function display	Type
	Order No.
	Qty.

VSPC TELE UK0 2WIRE

8924660000

1 ST

## Note





## VARITECTOR SPC

### VSPC RS485 - protection for data signals

- Pluggable arrester (impedance-neutral plugging/unplugging without interruption)
- Can be tested with the V-TEST testing device
- Optional monitoring function with status indicator and alert functions
- Lower residual voltage
- Version with floating-earth PE connection for avoiding voltage potential differences
- Tested in accordance with IEC 61643-21:08
- Integrated PE foot, safely discharges up to 20 kA (8/20  $\mu$ s) and 2.5 kA (10/350  $\mu$ s) to PE



### Technical data

Dielectric strength at FG against PE	$\geq 500$ V
Volume resistance	2.20 $\Omega$
Overload - failure mode	Modus 2
Requirements category acc. to IEC 61643-21	C1, C2, C3, D1
Surge current-carrying capacity C1	< 1 kA 8/20 $\mu$ s
Surge current-carrying capacity C2	5 kA 8/20 $\mu$ s
Surge current-carrying capacity C3	100 A 10/1000 $\mu$ s
Surge current-carrying capacity D1	2.5 kA 10/350 $\mu$ s
Discharge current $I_t$ (8/20 $\mu$ s) wire-wire/wire-PE/GND-PE	2.5 kA / 2.5 kA / 2.5 kA
Discharge $I_{max}$ (8/20 $\mu$ s) wire-wire/wire-PE/GND-PE	10 kA / 2 x 10 kA / 10 kA
Lightning test $I_{imp}$ (10/350 $\mu$ s) wire-wire/wire-PE/GND-PE	0.2 kA / 2 x 0.2 kA / 0.2 kA
Type of connection	Pluggable in VSPC BASE
Storage temperature	-40 °C...+80 °C
Ambient temperature (operational)	-40 °C...+70 °C
Protection degree	IP 20
<b>Failure probability</b>	
Ages	57
MTTF	2003
SIL in compliance with IEC 61508	3
<b>Approvals</b>	
Approvals	CE, GOSTME25, OEVE, TUEV, UL
Standards	IEC 61643-21

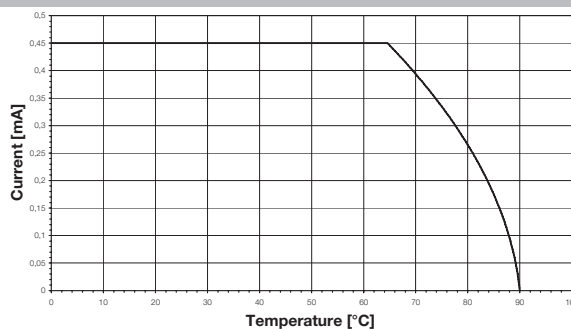
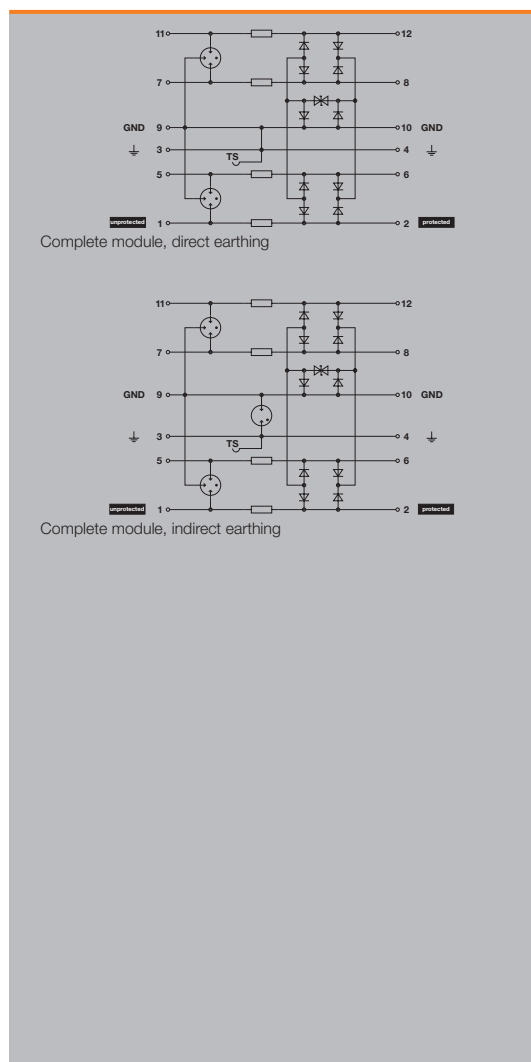

Dimensions of complete module (arrester + base element)	no remote sig. contact
Height x width x depth	mm 90 / 17.8 / 69
<b>Note</b>	The associated VSPC base element should be ordered with this. The dimension information provided refers to the complete module.

### Base elements / base to arresters



### Ordering data for base

Description	Type	Qty.	Order No.
Base element, direct earthing	VSPC BASE 2CL	1	8924710000
Base element, indirect earthing / floating earth FG	VSPC BASE 2CL FG	1	8924270000

**Note** Technical data can be found at the end of the VARITECTOR SPC section.

## VSPC RS485 - arrester / plug-in components



## Ordering data

Rated voltage (AC)  
 Rated voltage (DC)  
 Max. continuous voltage,  $U_c$  (AC)  
 Max. continuous voltage,  $U_c$  (DC)  
 Rated current  
 Input attenuation  
 Pulse-reset capacity  
 Residual voltage,  $U_r$ , typical

## VSPC RS485 2CH

5 V  
 6.4 V  
 450 mA  
 113.6 MHz  
 $\leq 20$  ms  
 35 V

## Protection level

Wire-wire 1 kV/ $\mu$ s, typically  
 Wire-wire 8/20  $\mu$ s, typically  
 Wire-PE 1kV/ $\mu$ s, typically  
 Wire-PE 8/20  $\mu$ s, typically

10 V  
 15 V  
 10 V  
 35 V

## Ordering data

No function display      Type  
    Order No.  
    Qty.

VSPC RS485 2CH  
**8924670000**  
 1 ST

## Note



## VARITECTOR SPC

### VSPC RS485 - protection for data signals with remote alert

- Pluggable arrester (impedance-neutral plugging/unplugging without interruption)
- Can be tested with the V-TEST testing device
- Optional monitoring function with status indicator and alert functions
- Lower residual voltage
- Version with floating-earth PE connection for avoiding voltage potential differences
- Tested in accordance with IEC 61643-21:08
- Integrated PE foot, safely discharges up to 20 kA (8/20 μs) and 2.5 kA (10/350 μs) to PE



**B**

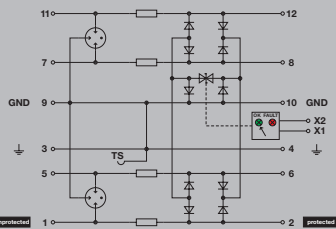

Complete module, direct earthing, with remote alert

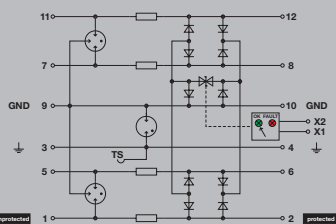

Complete module, indirect earthing, with remote alert

### Technical data

Dielectric strength at FG against PE	≥ 500 V
Volume resistance	2.20 Ω
Overload - failure mode	Modus 2
Requirements category acc. to IEC 61643-21	C1, C2, C3, D1
Surge current-carrying capacity C1	< 1 kA 8/20 μs
Surge current-carrying capacity C2	5 kA 8/20 μs
Surge current-carrying capacity C3	100 A 10/1000 μs
Surge current-carrying capacity D1	2.5 kA 10/350 μs
Discharge current I <sub>d</sub> (8/20 μs) wire-wire/wire-PE/GND-PE	2.5 kA / 2.5 kA / 2.5 kA
Discharge I <sub>max</sub> (8/20 μs) wire-wire/wire-PE/GND-PE	10 kA / 2 x 10 kA / 10 kA
Lightning test I <sub>imp</sub> (10/350 μs) wire-wire/wire-PE/GND-PE	0.2 kA / 2 x 0.2 kA / 0.2 kA
Type of connection	Pluggable in VSPC BASE
Storage temperature	-40 °C...+80 °C
Ambient temperature (operational)	-40 °C...+70 °C
Protection degree	IP 20
<b>Failure probability</b>	
Ages	90
MTTF	1266
SIL in compliance with IEC 61508	3
<b>Approvals</b>	
Approvals	CE, GOSTME25, OEVE, TUEV, UL
Standards	IEC 61643-21

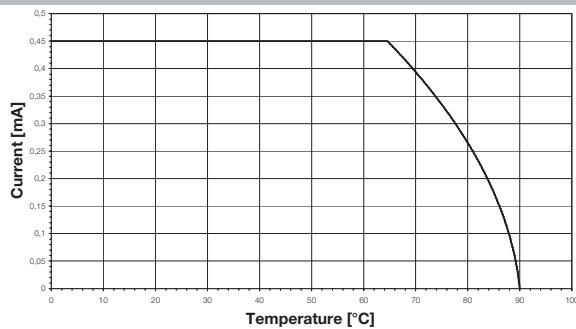

Dimensions of complete module (arrester + base element)	with remote signalling (R)
Height x width x depth	98 / 17.8 / 69
<b>Note</b>	The associated VSPC base element should be ordered with this. The dimension information provided refers to the complete module.

### Base elements / base to arresters



### Ordering data for base

Description	Type	Qty.	Order No.
Base element, indirect earthing with remote contact	VSPC BASE 2/4CH FG R	1	8951800000
Base element, direct earthing with remote contact	VSPC BASE 2/4CH R	1	8951790000

<b>Note</b>	Technical data can be found at the end of the VARITECTOR SPC section. Order with VSPC CONTROL UNIT.
-------------	---

**VSPC RS485 - arrester / plug-in components  
with remote alert**



**Ordering data**

		VSPC RS485 2CH R
Rated voltage (AC)		
Rated voltage (DC)		5 V
Max. continuous voltage, $U_c$ (AC)		
Max. continuous voltage, $U_c$ (DC)		6.4 V
Rated current		450 mA
Signalling contact		$U_N$ 250 V AC 0.1 A 1CO at VSPC R with VSPC CONTROL UNIT
Optical function display		green = OK; red = arrester is defective - replace
Input attenuation		113.6 MHz
Pulse-reset capacity		$\leq 20$ ms
Residual voltage, $U_r$ , typical		35 V
Protection level		
Wire-wire 1 kV/ $\mu$ s, typically		10 V
Wire-wire 8/20 $\mu$ s, typically		15 V
Wire-PE 1 kV/ $\mu$ s, typically		10 V
Wire-PE 8/20 $\mu$ s, typically		35 V

Ordering data		
With functional display	Type	VSPC RS485 2CH R
	Order No.	<b>8951670000</b>
	Qty.	1 ST
Note		



# VARITECTOR SPC

## Direct earthing

## Base element

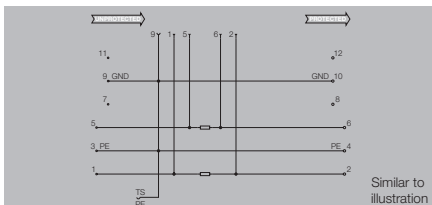

### Technical data

Stripping length, rated connection
Wire cross-section, stranded, min.
Wire cross-section, stranded, max.
Wire cross-section, solid, min.
Wire cross-section, solid, max.
Clamping range, rated connection, min.
Clamping range, rated connection, max.
Tightening torque, min.
Tightening torque, max.
Type of connection
Certificate No. (UL)
Approvals
Ambient temperature (operational)
Storage temperature
UL 94 flammability rating
Pollution severity
Surge voltage category

7 mm
0.5 mm <sup>2</sup>
2.5 mm <sup>2</sup>
0.5 mm <sup>2</sup>
4 mm <sup>2</sup>
0.5 mm <sup>2</sup>
4 mm <sup>2</sup>
0.5 Nm
0.8 Nm
Screw connection
E31 1081VOL1SEC2
CE, GOSTME25; UL
-40 °C...+70 °C
-40 °C...+80 °C
V-0
2
III

<b>Dimensions</b>
Height x width
mm

90 / 17.8
-----------

<b>Note</b>
-------------

### Ordering data

No remote sig. contact
------------------------

Type	Qty.	Order No.
VSPC BASE 1CL	1	8924730000
VSPC BASE 2SL	1	8924720000
VSPC BASE 2CL	1	8924710000
VSPC BASE 2/4CH	1	8924740000
VSPC BASE 1CL PW	1	1070230000
VSPC BASE 4SL	1	8924700000

<b>Note</b>
-------------

Technical data can be found at the end of the VARITECTOR SPC section.
---

### Accessories

<b>Note</b>
-------------

EMC Set: 1067470000 Marker: DEK 5
-----------------------------------

**Indirect earthing**

**Base element with FG**

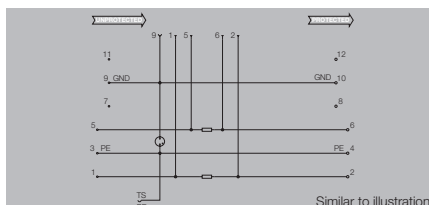

**Technical data**

Stripping length, rated connection
Wire cross-section, stranded, min.
Wire cross-section, stranded, max.
Wire cross-section, solid, min.
Wire cross-section, solid, max.
Clamping range, rated connection, min.
Clamping range, rated connection, max.
Tightening torque, min.
Tightening torque, max.
Type of connection
Certificate No. (UL)
Approvals
Ambient temperature (operational)
Storage temperature
UL 94 flammability rating
Pollution severity
Surge voltage category

7 mm
0.5 mm <sup>2</sup>
2.5 mm <sup>2</sup>
0.5 mm <sup>2</sup>
4 mm <sup>2</sup>
0.5 mm <sup>2</sup>
4 mm <sup>2</sup>
0.5 Nm
0.8 Nm
Screw connection
E31 1081VOL1SEC2
CE, GOSTME25; UL
-40 °C...+70 °C
-40 °C...+80 °C
V-0
2
III

<b>Dimensions</b>	
Height x width	mm

90 / 17.8
-----------

<b>Note</b>
-------------

**Ordering data**

No remote sig. contact

Type	Qty.	Order No.
VSPC BASE 1CL FG	1	8924290000
VSPC BASE 2SL FG	1	8924280000
VSPC BASE 2CL FG	1	8924270000
VSPC BASE 1CL PW FG	1	1105700000
VSPC BASE 2/4CH FG	1	8924300000
VSPC BASE 4SL FG	1	8924260000

<b>Note</b>
-------------

Technical data can be found at the end of the VARITECTOR SPC section.

**Accessories**

<b>Note</b>
-------------

EMC Set: 1067470000 Marker: DEK 5

# VARITECTOR SPC

Direct earthing, with remote alert

## Base element

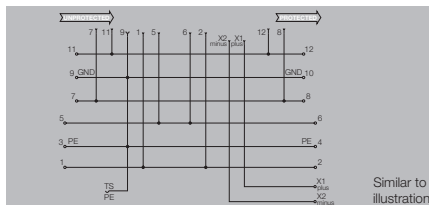

Similar to illustration

### Technical data

Stripping length, rated connection
Wire cross-section, stranded, min.
Wire cross-section, stranded, max.
Wire cross-section, solid, min.
Wire cross-section, solid, max.
Clamping range, rated connection, min.
Clamping range, rated connection, max.
Tightening torque, min.
Tightening torque, max.
Type of connection
Certificate No. (UL)
Approvals
Ambient temperature (operational)
Storage temperature
UL 94 flammability rating
Pollution severity
Surge voltage category

7 mm
0.5 mm <sup>2</sup>
2.5 mm <sup>2</sup>
0.5 mm <sup>2</sup>
4 mm <sup>2</sup>
0.5 mm <sup>2</sup>
4 mm <sup>2</sup>
0.5 Nm
0.8 Nm
Screw connection
E31 1081VOL1SEC2
CE, GOSTME25; UL
-40 °C...+70 °C
-40 °C...+80 °C
V-0
2
III

### Dimensions

Height x width mm

98 / 17.8

### Note

### Ordering data

With remote sig. contact (R)

Type	Qty.	Order No.
VSPC BASE 2SL R	1	895 1770000
VSPC BASE 1CL R	1	895 1730000
VSPC BASE 2CL R	1	895 1710000
VSPC BASE 2/4CH R	1	895 1790000
VSPC BASE 4SL R	1	895 1750000

### Note

Technical data can be found at the end of the VARITECTOR SPC section. Order with VSPC CONTROL UNIT.

### Accessories

#### Note

EMC Set: 1067470000 Marker: DEK 5

Indirect earthing, with remote alert

Base element with FG

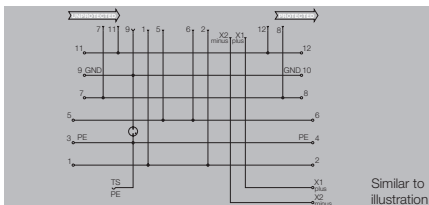

Technical data

- Stripping length, rated connection
- Wire cross-section, stranded, min.
- Wire cross-section, stranded, max.
- Wire cross-section, solid, min.
- Wire cross-section, solid, max.
- Clamping range, rated connection, min.
- Clamping range, rated connection, max.
- Tightening torque, min.
- Tightening torque, max.
- Type of connection
- Certificate No. (UL)
- Approvals
- Ambient temperature (operational)
- Storage temperature
- UL 94 flammability rating
- Pollution severity
- Surge voltage category

7 mm
0.5 mm <sup>2</sup>
2.5 mm <sup>2</sup>
0.5 mm <sup>2</sup>
4 mm <sup>2</sup>
0.5 mm <sup>2</sup>
4 mm <sup>2</sup>
0.5 Nm
0.8 Nm
Screw connection
E311081VOL1SEC2
CE, GOSTME25; UL
-40 °C...+70 °C
-40 °C...+80 °C
V-0
2
III

Dimensions

Height x width mm

98 / 17.8

Note

Ordering data

With remote sig. contact (R)

Type	Qty.	Order No.
VSPC BASE 2SL FG R	1	8951780000
VSPC BASE 1CL FG R	1	8951740000
VSPC BASE 2CL FG R	1	8951720000
VSPC BASE 2/4CH FG R	1	8951800000
VSPC BASE 4SL FG R	1	8951760000

Note

Technical data can be found at the end of the VARITECTOR SPC section. Order with VSPC CONTROL UNIT.

Accessories

Note

EMC Set: 1067470000 Marker: DEK 5

## VARITECTOR SPC

### VSPC accessories

#### V-Ground

- Can be applied to unassigned wires
- Usable during start-up and maintenance
- Earthing of all sensor cables
- Can be plugged into standard base sockets

#### V-Test-Connector

- Usable during start-up and maintenance
- For circuit voltage measurements using a standard 2.3-mm test socket
- Can be plugged into standard base sockets



VSPC TEST Connector 24 V DC

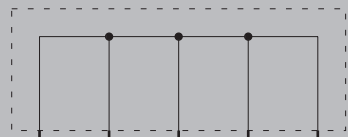

VSPC GROUND

### Technical data

Rated voltage (DC)	230 V AC
Max. continuous voltage, $U_c$ (DC)	255 V AC
Rated current	< 0.5 A
Volume resistivity per path	< 0.2 $\Omega$
Type of connection	Pluggable in VSPC BASE
Storage temperature	-40 °C...+80 °C
Ambient temperature (operational)	-40 °C...+70 °C
Rel. humidity	5 %...96 % RH
Degree of protection	IP 20

#### Note

### Ordering data

Arrester / plug-in elements	Type
	Order No.
	Qty.

#### Note

### VSPC TEST Connector 24 DC

VSPC TEST Connector 24DC  
8924690000

1

### VSPC GROUND

VSPC GROUND  
8924680000

1



### Ordering data

Shield connection:	Type	Qty.	Order No.
Complete set - cable ties and shield connection	EMC-set	1	1067470000
Cable ties	EMC-tie	100	1067490000
Shield connection	EMC-connector	50	1067520000
Cable tie tool	Cable tie tool RT-1	1	1296000000

The interlock mechanism on the VSPC Series pluggable arresters delivers extra reliability and an improved permanent contact under strong vibrating conditions.

### VSPC Locking Clip

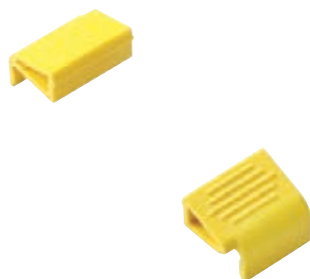

#### Technical data

Colour
Marking
Function
Weight
Note

yellow
Individually with a label
Removal with screwdriver
Snap-on by hand (press on)
10 g

#### Ordering data

Note
------

Type	Qty.	Order No.
VSPC LOCKING CLIP	100	1317340000

Cross-connection (QB) between the VSPC signal contacts can be installed quickly. Cross-connections can be individually separated for the alert function, with maximum of 10 VSPC R.

### QB 17,8/2



#### Technical data

Version
Dimensions (L x W x H)
Pitch
Rated current
Cross-section
Weight
Colour
Note

2-pole with 9 QBs together = 1 strip
9 mm (15.5 mm with contact) x 6 mm x 21 mm (9 QBs = 160.7 mm)
17.8 mm
17.5 A
1.5 mm <sup>2</sup>
12.4 g/QB
yellow

#### Ordering data

Note
------

Type	Qty.	Order No.
QB 17.8/2	10 strips, with 9 QBs each	1309470000

## VARITECTOR SPC

### VSPC CONTROL UNIT 24 V DC

- For monitoring up to 10 protective modules
- Signalling module for all VSPCs with status indicator
- Signalling of cable breaks / signal interruptions
- Voltage supply from 18...31 V DC
- Potential-free changeover contact
- Function indicator (red/green LED)
- Other NC-contact monitoring functions can be integrated into the signal circuit (e.g. PU I, PU II and PU III)



B

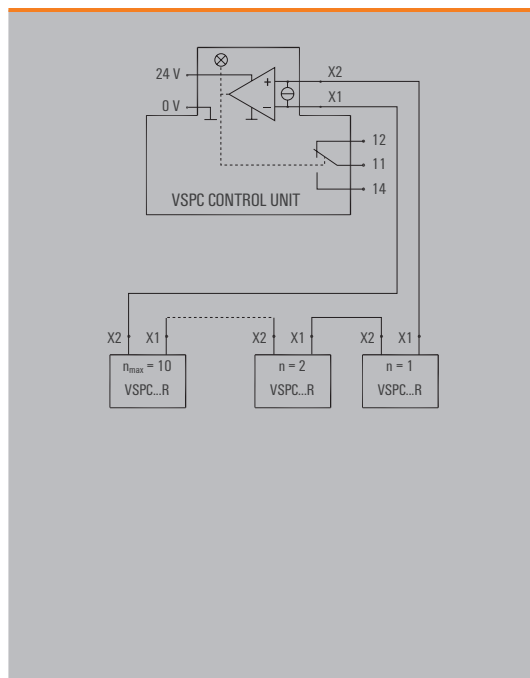

#### Technical data

<b>Input</b>	
Rated voltage (DC)	18 V...24 V DC...31 V DC
Rated current	max. 50 mA
Power rating	1.5 W
<b>Output</b>	
Current loop	8 mA at < 51 V
Monitoring option	1...10 VSPC modules
<b>Signal output</b>	
Type	1 CO contact
Max. switching voltage / continuous current	250 V / 1 A
<b>Diagnostics</b>	
Operating status	Green LED
Defect at current loop	Red LED (control unit and defective module)
Wire breakage	Red/green LED, flashing
<b>General data</b>	
Terminal rail	TS 35
Design, Protection class	Insta-enclosure, IP 20
Type of connection	BL / SL
Storage temperature	-40 °C...+80 °C
Ambient temperature (operational)	-40 °C...+70 °C
Rel. humidity	5 %...96 % RH
Start-up time after fault correction	60 s

<b>Dimensions</b>	
Dimensions incl. enclosure H x W x D	mm 102 x 18 x 71.5
<b>Note</b>	

#### Application

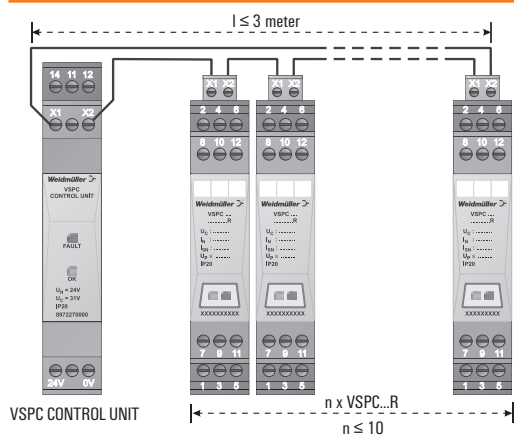

#### Status indication

LED green	LED red	Function	
		OK	✓
		Error (one or more VSPC ... R are defective)	
		Line break in the monitoring circuit; arrester pulled out or plug not in base	

#### Ordering data

Type	VSPC CONTROL UNIT 24Vdc
Order No.	<b>8972270000</b>
Qty.	1 piece
<b>Note</b>	

#### VSPC CONTROL UNIT 24 V DC

Type	VSPC CONTROL UNIT 24Vdc
Order No.	<b>8972270000</b>
Qty.	1 piece
<b>Note</b>	



## V-TEST

### Testing device from the VARITECTOR Series

#### A testing device for pluggable surge protection: for testing in compliance with the IEC 62305-3 standard

The V-TEST is a compact, easily carried, testing device for pluggable protection modules from the VARITECTOR SPC family. The testing device can be used to test the protective function of the overvoltage protection components in accordance with the test intervals required in IEC 62305-3. It provides information regarding the functional status of the protective components.

The backlit display shows the measured reading per component (GDT, MOV, TAZ) as "OK" or "not OK". This function allows you to detect ageing components as it highlights possible damage right away. Thus total protection is guaranteed.

The V-TEST is equipped with a charger and a battery set which allows autonomous use in the field. A comfortable and protective carry bag is delivered free with the tester.



#### Always delivers precise readings

The V-TEST self-calibrates when it is turned on, ensuring that it can always deliver precise measurement and test values.



#### Portable

The compact device comes with an integrated rechargeable battery and protective case – making it perfect for use in the field.



**Ensures timely testing intervals**

The portable V-TEST can be used to carry out repeated testing in compliance with IEC 62305-3.

Lightning protection level (LPL)	Interval for complete testing	Interval for visual inspection
I	2 years	1 year
II	4 years	2 years
III/IV	6 years	3 years

**Quick and easy to operate**

It only takes a few simple menu steps (in German or English) to navigate directly to the measurement function.



**V-TEST****VSPC accessories****V-TEST**

- Instrument for testing the protective functions of series: PU I, PU II and VSPC
- Device for realising standard IEC 62305 (periodic testing)
- Handy device with integrated battery set for local measurements
- Result display via LCD display
- Bilingual menu
- Including protective bag and power supply
- Intuitive user navigation in German and English

The V-TEST is a compact, portable instrument for the Varitector SPC pluggable surge protection (VSPC series) and surge protection for power distribution, PUI and II series. With this instrument, Weidmüller surge protection solutions can be tested for protective function in accordance with the required test periods as stipulated by IEC62305 (DIN VDE 185 Part 3). In a backlit display, the measurement result is indicated with "OK" or "not OK" for each component.

**Technical data**

Rated voltage	100...240 V AC
Accumulator set	8 NiMH with 2600 mA
Storage temperature	0 °C ... 40 °C
Ambient temperature (operational)	0 °C ... 40 °C
Degree of protection	IP 20
Measuring range	U < 1000 V / I = 1 mA
UL94 flammability class	V0

**General tolerances of measurement range**

Gas discharge tube	+/- 10%
Varistor	+/- 5%
TVS-diode	+/- 5%

**Note****Ordering data**

<b>Dimensions</b>	
Height x Width x Depth	mm
<b>Ordering data</b>	
Type	
Order No.	
Qty.	

**Note****V-TEST**

	230 x 122 x 65
	V-TEST
	<b>8951860000</b>
	1

# VARITECTOR SSC

## Surge protection in a terminal block: for measurement and control systems

### VARITECTOR SSC

Weidmüller's VARITECTOR SSC series for surge protection (VSSC4 and VSSC6) is well suited for protecting measurement and control circuits. It features good protective functionality in a compact terminal-block design. This is due to its 6.2 mm width. The combined Torx®/ slotted screw ensures that the proper nominal or max. torque is applied to the connection. The required screwdrivers are available from Weidmüller under the following order numbers:

4-mm slotted SD 0.8 x 4.0 x 100 (order no. 9008340000) or T15 Torx® (order no. 9009170000). The VSSC can be snapped on, to directly earth it to the DIN rail. The VSSC series is available with four clamping yokes (VSSC4) and six clamping yokes (VSSC6). The screw terminal has a nominal torque of 0.5 Nm, but it can be tightened to 0.8 Nm. The VARITECTOR SSC series is optimally designed for compact installation locations in process automation, industrial automation or building automation.

The two-stage surge protection terminals are equipped with gas discharge tubes (GDT), suppressor diodes (TVS) and decoupling components. Individual protective components (such as gas-filled spark gaps, varistors and suppressor diodes) supplement this product line. Our VARITECTOR SSC surge protectors are available for components with nominal voltages of 12 V, 24 V, 48 V to 230 V. Please contact us for other voltages or special applications.

The two-stage surge protection terminals are equipped with gas discharge tubes (GDT), suppressor diodes (TVS) and decoupling components. Individual protective

components (such as gas-filled spark gaps, varistors and suppressor diodes) supplement this product line. Our VARITECTOR SSC surge protectors are available for components with nominal voltages of 12 V, 24 V, 48 V to 230 V. Please contact us for other voltages or special applications. The PE contact is established by snapping onto an earthed DIN rail. The TS 35 must be earthed in order to ensure safe power discharging via the terminals of up to 20 kA (8/20  $\mu$ s) and 2.5 kA (10/350  $\mu$ s). The DIN rail must be screwed onto the earthed mounting plate to ensure EMC. The best protection is achieved when a PE contact is established every 60 cm / 24 inch using the terminal at the VARITECTOR SSC terminals with direct equipotential bonding. The cable should correspond to the max. cross-section of the VSSC connection. The four-port VARITECTOR SSC terminal can be used for binary and / or analogue signal circuits. The six-port VARITECTOR SSC can also be used to open signal circuits via an isolated level and monitor them using the optional built-in LED.

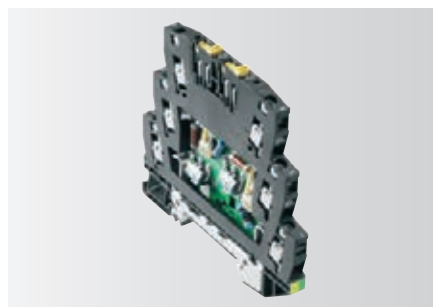

VARITECTOR SSC6



VARITECTOR SSC4

### Overview of model types

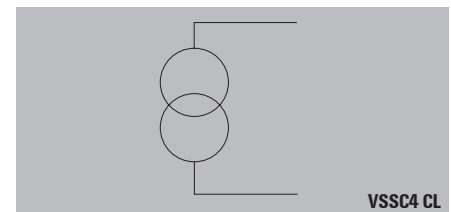

The **VSSC4 CL** is a two-stage protective combination that has a suppressor diode between the current paths. This VSSC4 CL limits the surge voltage in **an analogue signal circuit** (e.g. a current loop).

The **VSSC4 CL FG** is a two-stage protective combination that has a suppressor diode between the current paths. The gas discharge tube to the PE provides a high-resistance earthing for the protective circuitry. Thus the current loop can be operated with a floating ground. This VSSC4 CL FG limits the surge voltage in **an analogue unearthed signal circuit** (e.g. a current loop).

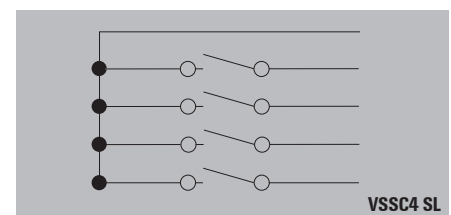

The basic principle of a binary current circuit

The **VSSC4 SL** is a two-stage protective combination with a suppressor diode for each stage from the current path to PE. This **VSSC4 SL** limits the surge voltage in an **earthed binary signal** (e.g. for alert contacts). The VSSC4 SL FG is used for **non-earthed signal circuits**.

# VARITECTOR SSC

The **VSSC4 SL FG** is a two-stage protective combination with a suppressor between the current paths and common return wire. The gas discharge tube to the PE provides a high-resistance earthing for the protective circuitry. Thus the protective circuitry can be operated with a floating earth. This VSSC4 SL FG limits the surge voltage in **a binary floating signal circuit**.

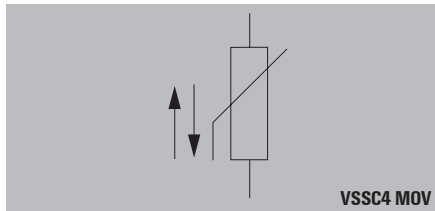

The **VSSC4 MOV** provides one-stage protection with a varistor (MOV) for the current path to PE. This **VSSC4 MOV** limits the surge voltage in **a circuit** (e.g. for solenoid valves). The thermally monitored MOV is available in voltages of 12 V, 24 V, 48 V, 60 V, 120 V, 150 V and 240 V.

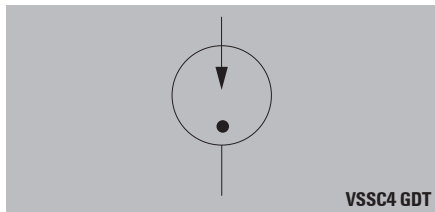

The **VSSC4 GDT** provides one-stage protection with a gas discharge tube (GDT) for the current path to PE. This **VSSC4 GDT** limits the surge voltage in **a circuit**. This terminal is used where no leakage current is permitted to flow to the earth, or where a high-impedance cable shield is connected to the earth. The GDT is available in voltages of 90 V, 110 V and 240 V.

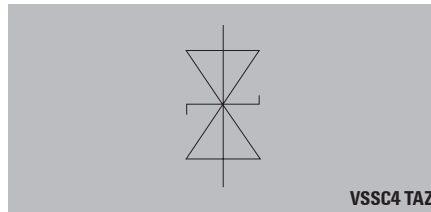

The **VSSC4 TAZ** provides one-stage protection with a quick-response (<10 ps) suppressor diode (TAZ) for the current path to PE. This **VSSC4 TAZ** limits the surge voltage in **a circuit** (e.g. for digital inputs). The TAZ is available in voltages of 12 V, 24 V, 48 V and 60 V.

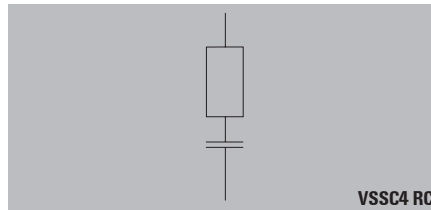

**VSSC4 RC** is the final protective variant in the VSSC series. This variant combines a thermally monitored varistor and an RC combination. It can be used for spark suppression on inductive loads. The VSSC4 RC is available in 24 V and 240 V.

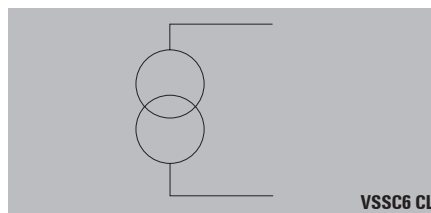

The **VSSC6 CL** is a two-stage protective combination that has a suppressor diode between the current paths. This VSSC6 CL limits the surge voltage in **an analogue signal circuit** (e.g. a current loop). The PE potential can be provided on terminal point 3/6 by snapping the terminal on an earthed DIN rail. This allows a shield connection to be connected. This version is also available as the **VSSC6 CL FG** floating-ground protective circuit.

The **VSSC6 TR CL** is built like the VSSC6 CL and also has two isolators. The 2.3-mm PS 2.3 (order number 018040000) can be plugged into the Torx® screw head. The isolation makes it possible to take measurements in the field, in the electrical cabinet or via the surge protection. This version is also available as the **VSSC6 TR CL FG** floating-ground protective circuit.

The **VSSC6 SL LD** is a two-stage protective combination with a suppressor between the current paths and common return wire. This VSSC6 SL limits the surge voltage in **two binary signal circuits**. The signal status for each signal circuit is indicated by an LED.

The **VSSC6 TR SL LD** is built like the VSSC6 L LD but also has two isolators. The 2.3-mm plug uses the screws to provide easy signal measurements. This version is also available as the **VSSC6 TR SL FG** floating-ground protective circuit.

The **VSSC6 MOV** provides one-stage protection with two thermally monitored varistors (MOV) between the current paths and common return wire. This VSSC6 MOV limits the surge voltage in **two binary signal circuits**.

The **VSSC6 TR LD MOV** provides one-stage protection with two thermally monitored varistors (MOV) between the current paths and common return wire. The VSSC6 MOV limits the surge voltage in **two binary signal circuits** and also has an isolator and an LED for each signal circuit.



The **VSSC6 GDT** provides one-stage protection with two gas discharge tubes (GDT) between the current paths and common return wire. This VSSC6 GDT limits the surge voltage in **two binary signal circuits**.

The **VSSC6 TR LD GDT** provides two-stage protection with two gas discharge tubes (GDT) between the current paths and common return wire. The VSSC6 GDT limits the surge voltage in **two binary signal circuits** and also has an isolator for each signal circuit.

The **VSSC6 TAZ** provides one-stage protection with two suppressor diodes (TAZ) between the current paths and common return wire. The VSSC6 TAZ limits the surge voltage in **two binary signal circuits** and also has an isolator and an LED for each signal circuit.

The **VSSC6 TR LD TAZ** provides one-stage protection with two suppressor diodes (TAZ) between the current paths and common return wire. The VSSC6 TAZ limits the surge voltage in **two binary signal circuits** and also has an isolator and an LED for each signal circuit.

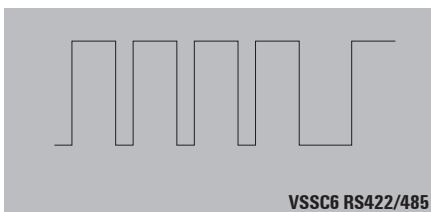

The **VSSC6 RS485** is a two-stage protective combination that has suppressor diodes between the current paths. This VSSC6 RS485 limits the surge voltage in **two high-frequency signal circuits** with common return wires. The VSSC6 RS485 is available in the PROFIBUS PA and DP variants.

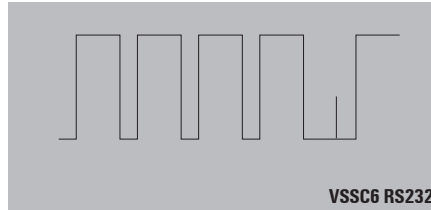

The **VSSC6 RS232** is a two-stage protective combination that has suppressor diodes between the current paths. This VSSC6 RS232 limits the surge voltage in **a signal circuit**.

Black Material PA6.6 with UL94 V0 is used for the VSSC4 and VSSC6 series so that they are suitable for use in many applications. They are suitable for use in temperatures ranging from -40 to +70 °C.

#### Discharge capacity

Tested in compliance with standard IEC 61643-21 for providing surge protection in signalling networks with voltage and current pulses. The VSSC series has been tested to comply with IEC 61643-21 and EN 61643-21. Modules were tested with categories C1, C2 and C3: with quick-rising edges with up to 300 pulses. Category D1 describes high-power testing (10/350 µs), so that the VSSC series can be used in compliance with IEC 62305-4. The VSSC is colour-coded so that it is easy to detect the voltage level (or the signal location SL or CL).

#### Colour coding

Voltage level	Colour
≤ 12 V	green
24 V Binary	blue
24 V Analogue	yellow
48 V	red
≥ 60 V	violet
Special function	white

#### Installation

The VSSC series is used to protect signal circuits. In order to achieve a complete protective strategy for the facility, the power feed must be protected with Type II surge protection (for example, by using the VPU II series).

For existing lightning protection facilities, Type I protection must be used (for example, by using the VPU I series). Type II protection (for example, the VPU II) is sufficient when there is no lightning protection facility.

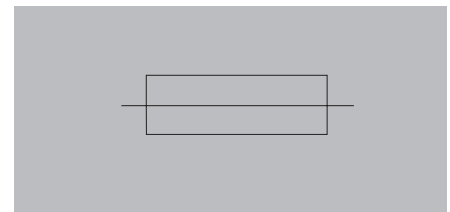

#### Fusing

The VSPC surge protection modules are designed so that they are decoupled between the individual protective stages. When relying on an external fuse, make sure to maintain the following:

- Maximum nominal current
- Derating curve
- Type of installation
- Application

#### Category

**IEC 61643-21  
C1, C2, C3, D1**

# VARITECTOR SSC

Category	Testing pulse	Surge voltage	Surge current	Pulse	Type
C1	Quick rising edge	0,5 < 2 kV with 1.2/50 µs	0.25 < 1 kA with 8/20 µs	300	Surge voltage arrester
C2	Quick rising edge	2 < 10 kV with 1.2/50 µs	1 < 5 kA with 8/20 µs	10	Surge voltage arrester
C3	Quick rising edge	≥ 1 kV with 1 kV/µs	10 < 100 A with 10/10.000 µs	300	Surge voltage arrester
D1	High power	≥ 1 kV	0.5 < 2.5 kA with 10/350 µs	2	Arrester for lightning current and surge voltages

Category C reflects the interference pulses with quick-rising edges and minimised power. Category D uses quick-rising edges and high power to detail the interference pulses. This energy simulates the high-power load that stems from coupled partial lightning currents.

## General technical data

Storage temperature: -40 °C ... +80 °C  
 Operating temperature:  
 -40 °C ... +70 °C  
 Humidity: 5 % ... 96 % 5 %...96 %  
 RH without condensation  
 Material: VO, IP 20

Connection: VSSC4 and VSSC6  
 Torx®: T15 900917  
 Slotted: 0.8 x 4  
 (order number 9008340000)  
 Nominal torque: 0.5 Nm  
 Max. Drehmoment: 1 Nm  
 Max. torque: 10 mm  
 Solid core: 0.5...6 mm<sup>2</sup>  
 Stranded: 0.5 ... 4 mm<sup>2</sup>  
 Finely stranded: 0.5 .... 4 mm<sup>2</sup>  
 Finely stranded with ferrule:  
 0.5 .... 4 mm<sup>2</sup>

## Dimensions

### VSSC4:

Width: 6.1 mm  
 Width with frame: 12.2 mm  
 Height: 76 mm  
 Depth: 58.5 mm with TS 35 x 7.5

Top connections:

Unprotected: 1  
 Protected: 4

Bottom connections:

Unprotected: 2  
 Protected: 3

### VSSC6:

Width: 6.1 mm  
 Width with frame: 12.2 mm  
 Height: 88.5 mm  
 Depth: 81 mm with TS 35 x 7.5

Top connections:

Unprotected: 1  
 Protected: 4

Mid-level connections:

Unprotected: 2  
 Protected: 5

Bottom connections:

Unprotected: 3  
 Protected: 6

## Markers for VSSC4 and VSSC6:

Dekafix: DEK 5 for the connections  
 WS 10/6 middle as device marker  
 SNAPMARK only for the VSSC6 and  
 DEK5/5 for the terminal points.

## Derating curves

### VSSC4 GDT MOV TAZ

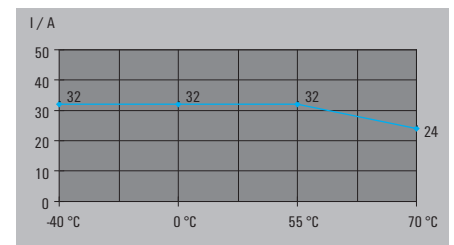

### VSSC4 RC

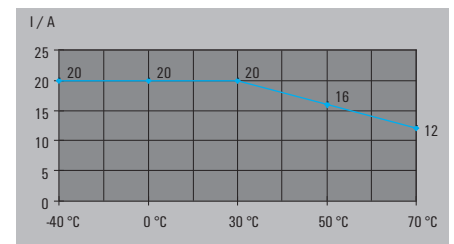

### VSSC6 GDT MOV

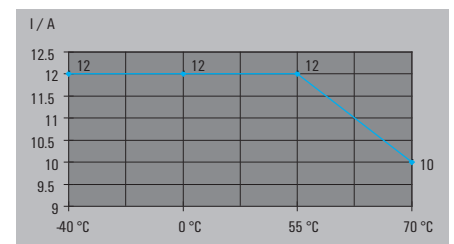

## Other VSSC4 und VSS

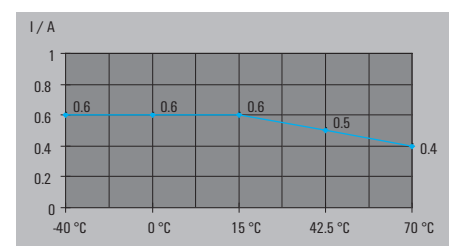

# Quick product selection for the VARITECTOR SSC

## Technical data

Interface	Product designation	Order No.
0(4) ... 20 mA / 0 ... 10 V	VSSC4 CL 24 V UC 0.5 A	1063730000
	VSSC6 CL 24 V UC 0.5 A	1064170000
	VSSC6TR CL FG 24 V UC 0.5 A	1064310000
	VSSC4 CL FG 24 V UC 0.5 A	1063770000
	VSSC6 CL FG 24 V UC 0.5 A	1064270000
	VSSC6TR CL FG 24 V UC 0.5 A	1064310000
ARCNET (Plus)	VSSC6 RS485	1064980000
BLN (Building Level Network)	see 0(4) ... 20 mA / 0 ... 10 V	
DeviceNet	VSSC6 RS485	1064980000
DIN measurement bus	see 0(4) ... 20 mA / 0 ... 10 V	
Dupline / Miniplex	VSSC6 CL 12 V DC 0.5 A	1064150000
EIB (European Instalation Bus)	VSSC6 GDT 110 V UC 10 kA	1064690000
EIB (European Instalation Bus)	VSSC6 GDT 110 V UC 20 kA	1064700000
ET200	VSSC6 CL 12 V DC 0.5 A	1064150000
Genius I/O Bus	see 0(4) ... 20 mA / 0 ... 10 V	
Hart	see 0(4) ... 20 mA / 0 ... 10 V	
Cathodic corrosion protection	VSSC6 GDT 230 V UC 20 kA	1064720000
LON™ (Works)	VSSC6 CL 48 V UC 0.5 A	1064190000
M-Bus (Remote meter reading)	see 0(4) ... 20 mA / 0 ... 10 V	
MPI Bus	VSSC6 RS485	1064980000
N2 Bus	VSSC6 SL LD 12 V DC 0.5 A	1064340000
Procontic CS31	VSSC6TR CL FG 12 V DC 0.5 A	1064300000
Profibus DP (FMS)	VSSC6 RS485 DP	
PT100	VSSC6 RTD	1139710000
PSM-EG-RS422...	VSSC6 RS485 DP	1065010000
PSM-EG-RS485...	VSSC6 RS485 DP	1065010000
RS422A, V.11, X.27, RS423A	VSSC6 RS485 DP	1065010000
RS485	VSSC6 RS485 DP	1065010000
RS232-C / V.24	VSSC6 RS232	1064990000
SecurILan-LON™-Bus	see 0(4) ... 20 mA / 0 ... 10 V	
(Profibus DP)	VSSC6 RS485 DP	1065010000
TTY, 0(4) - 20 mA	see 0(4) ... 20 mA / 0 ... 10 V	
U-BUS	VSSC6 GDT 110 V UC 20 kA	1064700000

**Note:** This tables contains selection recommendations. Our technical consultants will be glad to assist you with your individual application requirements.

# VARIRECTOR SSC 6AN

## Lightning and surge protection in terminal block design

### Lightning and surge protection in 6 mm overall width for measurement and control circuits including isolation/measuring function

B

The VARIRECTOR SSC combined surge protection, a direct PE contact function, separation of signal paths and operational status indication in one module. It is suitable for C&I applications.

The disconnect lever in the terminal guarantees that the measurement/control circuit can be quickly and precisely switched off to test the signal path. Using a test plug (PS 2.3 mm), the measuring instrument can be easily inserted into the integrated test socket on Torx®/Slot headed screws. The shield can be attached onto the additional lower level of the VSSC 6AN which then leads directly to the PE potential on the mounting rail. Permanent shielding can be implemented easily using the EMC set. Weidmüller's SNAPMARK device marker can be snapped onto a terminal so that the equipment identification can be easily read regardless of the installation position. The VSSC 6AN features all the advantages found in the VARIRECTOR SSC product line: a thin 6.2 mm width, quick PE contact to rail (with up to 20 kA discharge capacity), simple colour coding for quick identification, large-surface versatile markers, and the new Torx®/slot headed screw.

All VARIRECTOR products comply with the latest IEC 61643-21:2008 requirement for a new overstress mode and with categories D1, C3, C2 and C1 according to IEC 61643-22.

#### Convenient

Connection convenience is assured by a clamping range of 0.5 mm<sup>2</sup> to 6 mm<sup>2</sup> with a Torx®/slot headed screw and a 0.8 Nm tightening torque.



#### Space-saving

A terminal of just 6.2 mm for two binary signals or one analogue signals. Terminals can be fitted side by side.

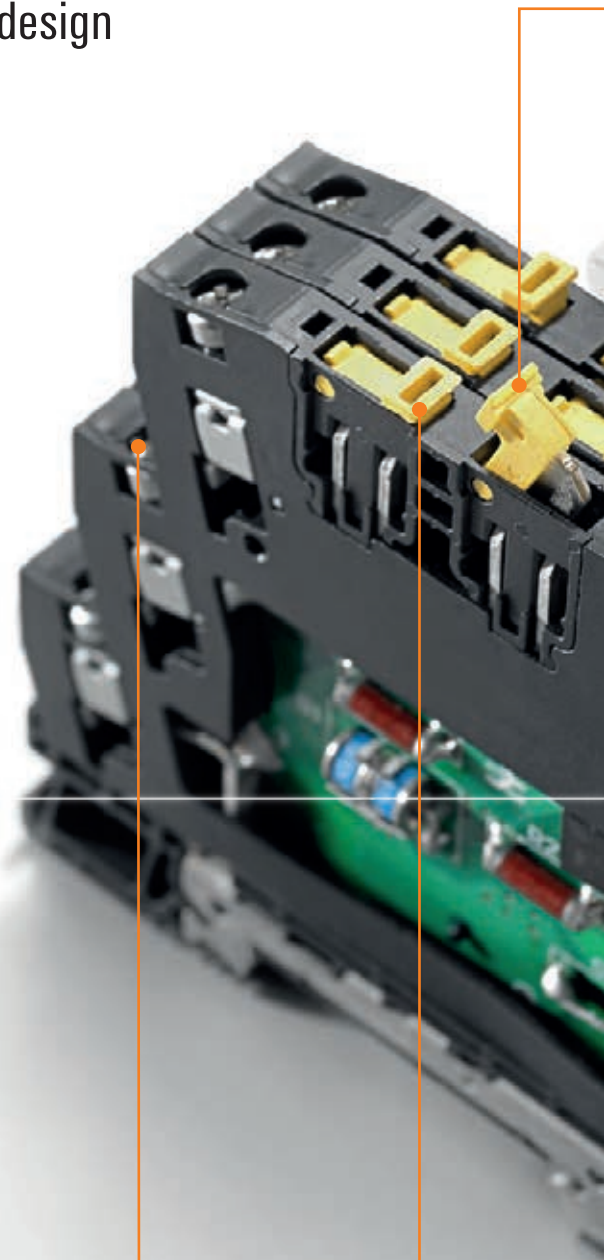

**Simple and precise isolation**

The disconnect lever guarantees a simple signal path disconnection and a safe disconnect point that is easy to see.

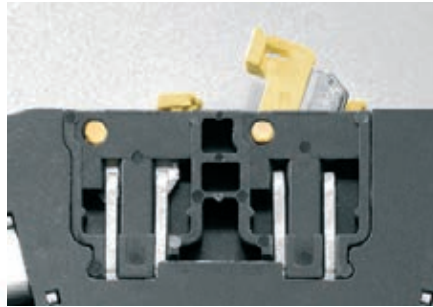
**Fast identification**

Versatile marking options: markers for equipment and terminals and SNAPMARK markers that are easy to read in any installation position.

B

**Testing and measuring**

To enable simple testing it is possible to insert the test plug (PS 2.3 mm) of the measuring instrument into the integrated test socket of the Torx®/slot headed screw.

**Easy and safe**

A shield can be mounted on both sides of the unit which will provide direct connection to PE. It features a very high discharge current of up to 20 kA for increased plant safety.

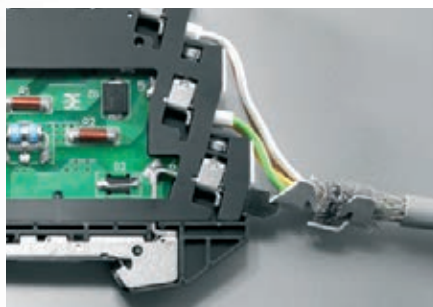

## VARITECTOR SSC 6AN

### VSSC 6 CL and CL FG - protection for analogue signals

- Two-stage surge protection with screw connection for measurement and control signals
- Surge protection in terminal block design
- Modular width of only 6.2 mm
- Space-saving design: 1 analogue signal
- Torx® slotted screw connection
- Can be used in compliance with installation standard IEC 62305
- Tested in accordance with IEC 61643-21: D1, C2, C3
- Integrated PE foot, safely discharges up to 20 kA (8/20 µs) and 2.5 kA (10/350 µs) to PE

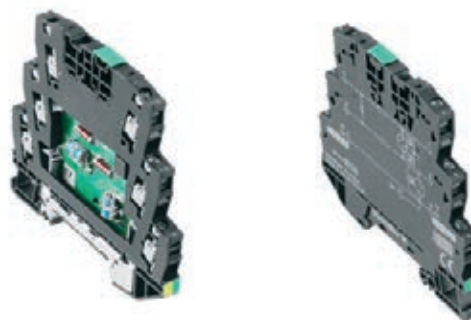

## B

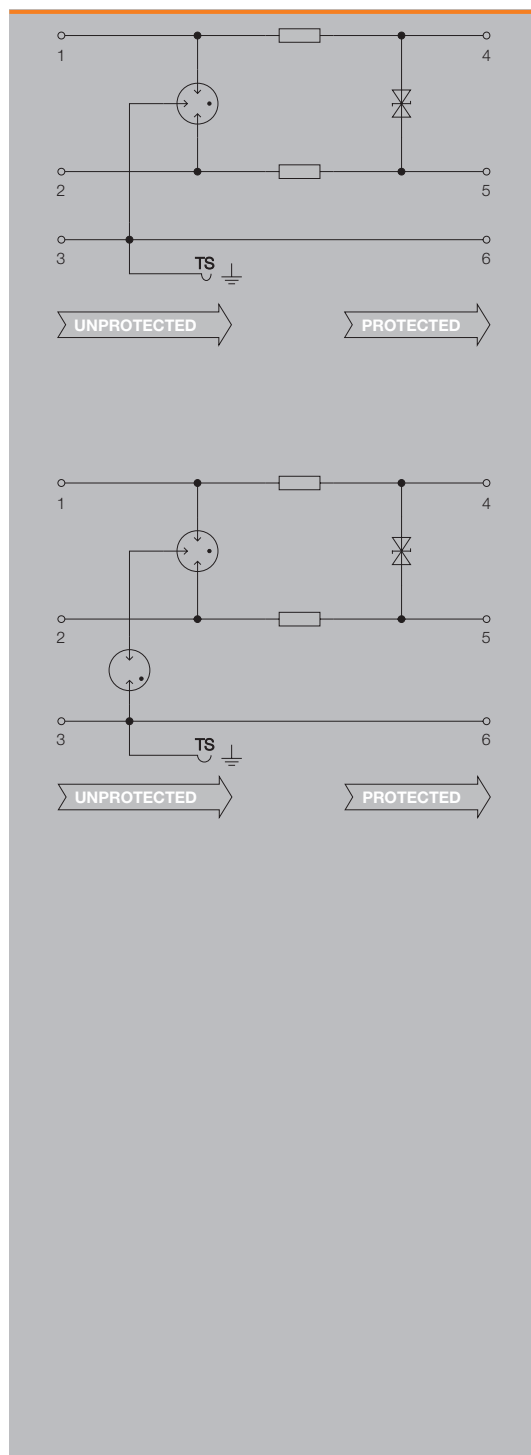

### Technical data

Rated current	500 mA
Dielectric strength at FG against PE	≥ 500 V
Volume resistance	1.8 Ω 10 %
Overload - failure mode	Modus 2
Requirements category acc. to IEC 61643-21	C2, C3, D1
Standards	IEC 61643-21
Surge current-carrying capacity C1	
Surge current-carrying capacity C2	2.5 kA
Surge current-carrying capacity C3	50 A
Surge current-carrying capacity D1	0.5 kA
Discharge current $I_t$ (8/20 µs) wire-wire/wire-PE/GND-PE	2.5 kA / 2.5 kA /
Discharge $I_{max}$ (8/20 µs) wire-wire/wire-PE/GND-PE	5 kA / 5 kA /
Lightning test $I_{imp}$ (10/350 µs) wire-wire/wire-PE/GND-PE	/ 0.5 kA /
Storage temperature	-40 °C...+80 °C
Ambient temperature (operational)	-40 °C...+70 °C
Protection degree	IP 20
UL 94 flammability rating	V-0
<b>Connection data</b>	
Type of connection	Screw connection, Torx® T15, Slotted 0.8 x 4
Tightening torque	0.5 Nm
Wire connection cross section, finely stranded, max.	4 mm <sup>2</sup>
Wire connection cross-section, finely stranded, min.	0.5 mm <sup>2</sup>
Wire cross-section, solid, max.	6 mm <sup>2</sup>
Wire cross-section, solid, min.	0.5 mm <sup>2</sup>
Wire cross-section, stranded, max.	4 mm <sup>2</sup>
Wire cross-section, stranded, min.	0.5 mm <sup>2</sup>
Stripping length	10 mm
Mounting rail	TS 35
<b>Failure probability</b>	
λges	19
MTTF	6008
SIL in compliance with IEC 61508	2
<b>Approvals</b>	
Approvals	CE; GOSTME25; OEVE; TUEV; UL; ROHS
Standards	IEC 61643-21

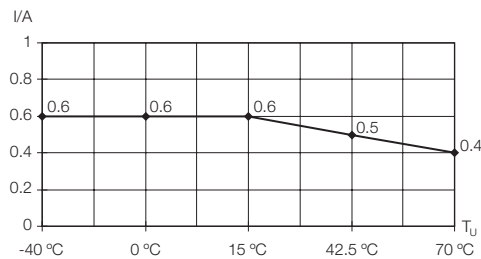

### Dimensions

Height x width x depth mm 88.5 / 6.1 / 81

### Note

VSSC 6 CL and CL FG

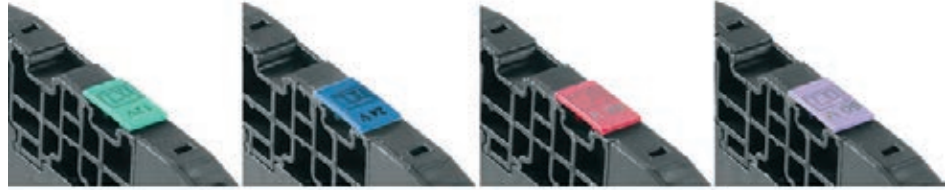

Ordering data

Rated voltage (AC)
Rated voltage (DC)
Max. continuous voltage, U <sub>c</sub> (AC)
Max. continuous voltage, U <sub>c</sub> (DC)
Rated current
Optical function display
Isolating function
Input attenuation
Pulse-reset capacity
Residual voltage, U <sub>r</sub> , typical

	CL 12 V DC	CL 24 V UC	CL 48 V UC	CL 60 V UC
Rated voltage (AC)		24 V	48 V	60 V
Rated voltage (DC)	12 V	34 V	68 V	85 V
Max. continuous voltage, U <sub>c</sub> (AC)		30 V	60 V	75 V
Max. continuous voltage, U <sub>c</sub> (DC)	15 V	42 V	85 V	106 V
Rated current	500 mA	500 mA	500 mA	500 mA
Optical function display	No	No	No	No
Isolating function	No	No	No	No
Input attenuation	≤ 700 kHz	3.4 MHz	5 Mhz	6.8 MHz
Pulse-reset capacity	≤ 20 ms	≤ 170 ms	≤ 150 ms	≤ 20 ms
Residual voltage, U <sub>r</sub> , typical	900 V	900 V	764 V	777 V

Ordering data

Type	VSSC6 CL 12VDC 0.5A	VSSC6 CL 24VAC/DC 0.5A	VSSC6 CL 48VAC/DC 0.5A	VSSC6 CL 60VAC/DC 0.5A
Order No.	<b>1064150000</b>	<b>1064170000</b>	<b>1064190000</b>	<b>1064210000</b>
Qty.	10 ST	10 ST	10 ST	10 ST
Note	End plate AP VSSC6 1063110000	End plate AP VSSC6 1063110000	End plate AP VSSC6 1063110000	End plate AP VSSC6 1063110000

Ordering data

Rated voltage (AC)
Rated voltage (DC)
Max. continuous voltage, U <sub>c</sub> (AC)
Max. continuous voltage, U <sub>c</sub> (DC)
Rated current
Optical function display
Isolating function
Input attenuation
Pulse-reset capacity
Residual voltage, U <sub>r</sub> , typical

	CLFG 12 V DC	CLFG 24 V UC	CLFG 48 V UC	CLFG 60 V UC
Rated voltage (AC)		24 V	48 V	60 V
Rated voltage (DC)	12 V	34 V	68 V	85 V
Max. continuous voltage, U <sub>c</sub> (AC)		30 V	60 V	75 V
Max. continuous voltage, U <sub>c</sub> (DC)	15 V	42 V	85 V	106 V
Rated current	500 mA	500 mA	500 mA	500 mA
Optical function display	No	No	No	No
Isolating function	No	No	No	No
Input attenuation	≤ 700 kHz	3.4 MHz	5 Mhz	6.8 MHz
Pulse-reset capacity	≤ 20 ms	≤ 20 ms	≤ 20 ms	≤ 20 ms
Residual voltage, U <sub>r</sub> , typical	1600 V	1632 V	1506 V	1512 V

Ordering data

Type	VSSC6 CLFG 12VDC 0.5A	VSSC6 CLFG24VAC/DC0.5A	VSSC6 CLFG48VAC/DC0.5A	VSSC6 CLFG60VAC/DC0.5A
Order No.	<b>1064260000</b>	<b>1064270000</b>	<b>1064280000</b>	<b>1064290000</b>
Qty.	10 ST	10 ST	10 ST	10 ST
Note	End plate AP VSSC6 1063110000	End plate AP VSSC6 1063110000	End plate AP VSSC6 1063110000	End plate AP VSSC6 1063110000



## VARITECTOR SSC 6AN

### VSSC 6 TR CL and TR CL FG - protection for floating current loops

- Two-stage surge protection with screw connection for measurement and control signals
- Surge protection in terminal block design
- Modular width of only 6.2 mm
- Space-saving design: 1 analogue signal
- Torx® slotted screw connection
- Can be used in compliance with installation standard IEC 62305
- Tested in accordance with IEC 61643-21: D1, C2, C3
- Integrated PE foot, safely discharges up to 20 kA (8/20 μs) and 2.5 kA (10/350 μs) to PE

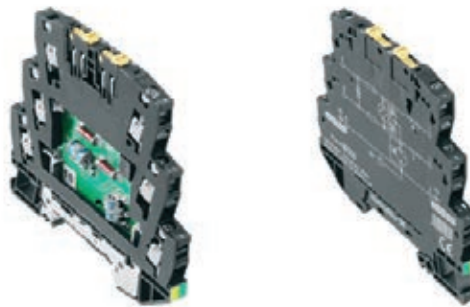

**B**

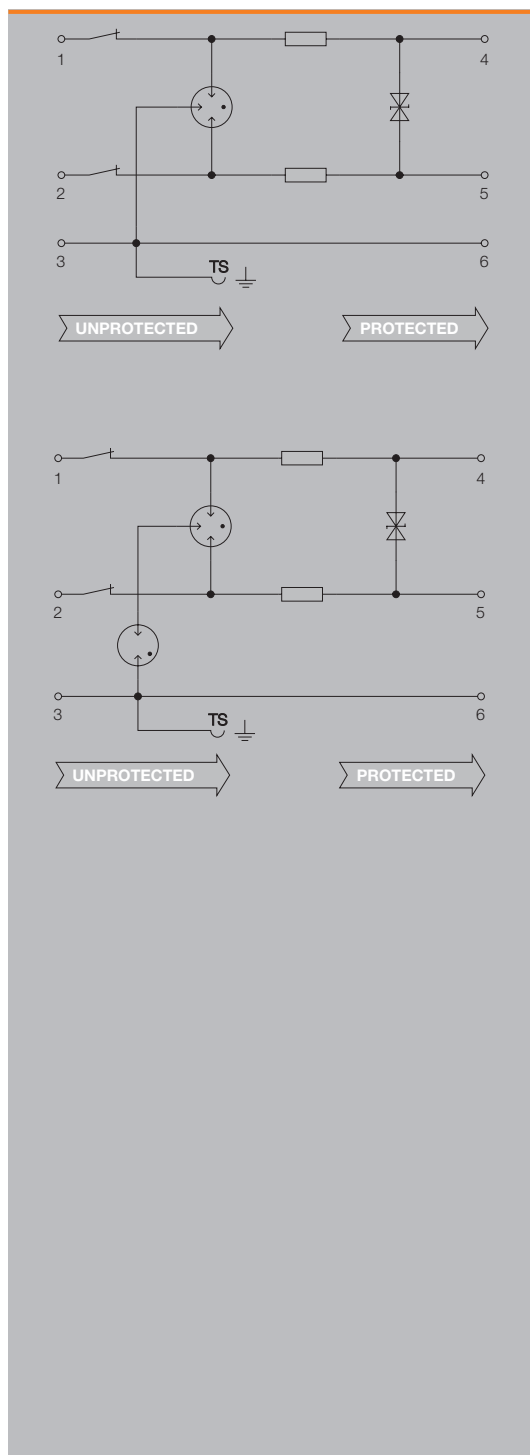

### Technical data

Rated current	500 mA
Dielectric strength at FG against PE	≥ 500 V
Volume resistance	1.8 Ω 10 %
Overload - failure mode	Modus 2
Requirements category acc. to IEC 61643-21	C2, C3, D1
Standards	IEC 61643-21
<b>Surge current-carrying capacity C1</b>	
Surge current-carrying capacity C2	2.5 kA 8/20 μs 5 kV 1.2/50 μs
Surge current-carrying capacity C3	50 A 10/1000 μs
Surge current-carrying capacity D1	0.5 kA 10/350 μs
Discharge current I <sub>d</sub> (8/20 μs) wire-wire/wire-PE/GND-PE	2.5 kA / 2.5 kA /
Discharge I <sub>max</sub> (8/20 μs) wire-wire/wire-PE/GND-PE	5 kA / 5 kA /
Lightning test I <sub>imp</sub> (10/350 μs) wire-wire/wire-PE/GND-PE	/ 0.5 kA /
Storage temperature	-40 °C...+80 °C
Ambient temperature (operational)	-40 °C...+70 °C
Protection degree	IP 20
UL 94 flammability rating	V-0
<b>Connection data</b>	
Type of connection	Screw connection, Torx® T15, Slotted 0.8 x 4
Tightening torque	0.5 Nm
Wire connection cross section, finely stranded, max.	4 mm <sup>2</sup>
Wire connection cross-section, finely stranded, min.	0.5 mm <sup>2</sup>
Wire cross-section, solid, max.	6 mm <sup>2</sup>
Wire cross-section, solid, min.	0.5 mm <sup>2</sup>
Wire cross-section, stranded, max.	4 mm <sup>2</sup>
Wire cross-section, stranded, min.	0.5 mm <sup>2</sup>
Stripping length	10 mm
Mounting rail	TS 35
<b>Failure probability</b>	
λges	19
MTTF	6008
SIL in compliance with IEC 61508	2
<b>Approvals</b>	
Approvals	CE; GOSTME25; OEVE; TUEV; UL; ROHS
Standards	IEC 61643-21

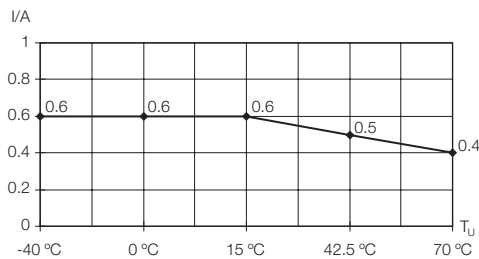

### Dimensions

Height x width x depth mm 88.5 / 6.1 / 81

### Note

## VSSC 6TR CL and TR CL FG

## Ordering data

	TR CL 12 V DC	TR CL 24 V UC	TR CL 48 V UC	TR CL 60 V UC
Rated voltage (AC)		24 V	48 V	60 V
Rated voltage (DC)	12 V	34 V	68 V	85 V
Max. continuous voltage, U <sub>c</sub> (AC)		30 V	60 V	75 V
Max. continuous voltage, U <sub>c</sub> (DC)	15 V	42 V	85 V	106 V
Rated current	500 mA	500 mA	500 mA	500 mA
Optical function display	No	No	No	No
Isolating function	Yes	Yes	Yes	Yes
Input attenuation	270 Mhz	270 Mhz	270 Mhz	270 Mhz
Pulse-reset capacity	≤ 20 ms	≤ 170 ms	≤ 150 ms	≤ 20 ms
Residual voltage, U <sub>r</sub> , typical	900 V	900 V	764 V	777 V

## Ordering data

	TR CL 12 V DC	TR CL 24 V UC	TR CL 48 V UC	TR CL 60 V UC
Type	VSSC6 TR CL 12VDC 0.5A	VSSC6 TRCL24VAC/DC0.5A	VSSC6 TRCL48VAC/DC0.5A	VSSC6 TRCL60VAC/DC0.5A
Order No.	<b>1064220000</b>	<b>1064230000</b>	<b>1064240000</b>	<b>1064250000</b>
Qty.	10 ST	10 ST	10 ST	10 ST
Note	End plate AP VSSC6 1063110000	End plate AP VSSC6 1063110000	End plate AP VSSC6 1063110000	End plate AP VSSC6 1063110000

## Ordering data

	TR CLFG 12 V DC	TR CLFG 24 V UC	TR CLFG 48 V UC	TR CLFG 60 V UC
Rated voltage (AC)		24 V	48 V	60 V
Rated voltage (DC)	12 V	34 V	68 V	85 V
Max. continuous voltage, U <sub>c</sub> (AC)		30 V	60 V	75 V
Max. continuous voltage, U <sub>c</sub> (DC)	15 V	42 V	85 V	106 V
Rated current	500 mA	500 mA	500 mA	500 mA
Optical function display	No	No	No	No
Isolating function	Yes	Yes	Yes	Yes
Input attenuation	270 Mhz	270 Mhz	270 Mhz	270 Mhz
Pulse-reset capacity	≤ 20 ms	≤ 20 ms	≤ 20 ms	≤ 20 ms
Residual voltage, U <sub>r</sub> , typical	900 V	1632 V	1506 V	1512 V

## Ordering data

	TR CLFG 12 V DC	TR CLFG 24 V UC	TR CLFG 48 V UC	TR CLFG 60 V UC
Type	VSSC6TRCLFG12VDC0.5A	VSSC6TRCLFG24VAC/DC0.5A	VSSC6TRCLFG48VAC/DC0.5A	VSSC6TRCLFG60VAC/DC0.5A
Order No.	<b>1064300000</b>	<b>1064310000</b>	<b>1064320000</b>	<b>1064330000</b>
Qty.	10 ST	10 ST	10 ST	10 ST
Note	End plate AP VSSC6 1063110000	End plate AP VSSC6 1063110000	End plate AP VSSC6 1063110000	End plate AP VSSC6 1063110000

## VARITECTOR SSC 6AN

### VSSC 6 SL and SL FG - protection for binary signals with signal display

- One-stage surge protection with screw connection for measurement and control signals
- Surge protection in terminal block design
- Modular width of only 6.2 mm
- Space-saving design for two signals
- Torx® slotted screw connection
- Can be used in compliance with installation standard IEC 62305
- Tested in accordance with IEC 61643-21: C1, C2
- Integrated PE foot, safely discharges up to 20 kA (8/20 μs) and 2.5 kA (10/350 μs) to PE

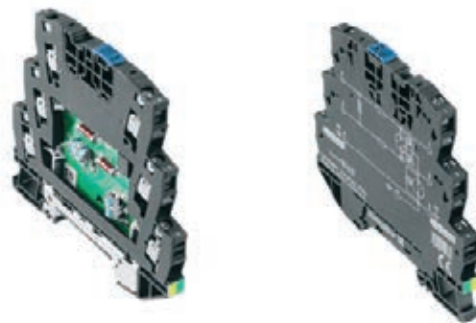

**B**

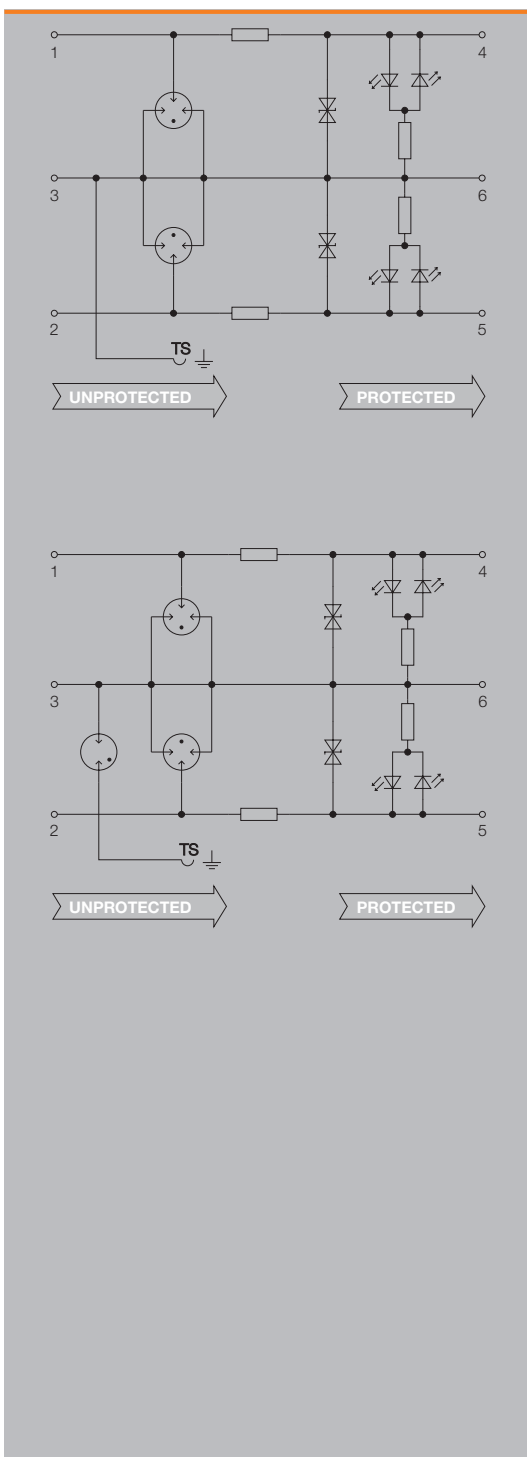

### Technical data

Rated current	500 mA
Dielectric strength at FG against PE	≥ 500 V
Volume resistance	1.8 Ω 10 %
Overload - failure mode	Modus 2
Requirements category acc. to IEC 61643-21	C2, C3, D1
Standards	IEC 61643-21
Surge current-carrying capacity C1	
Surge current-carrying capacity C2	2.5 kA 8/20 μs
Surge current-carrying capacity C3	10 A 10/1000 μs
Surge current-carrying capacity D1	1 kA 10/350 μs
Discharge current I <sub>d</sub> (8/20 μs) wire-wire/wire-PE/GND-PE	/ 2.5 kA /
Discharge I <sub>max</sub> (8/20 μs) wire-wire/wire-PE/GND-PE	/ 10 kA /
Lightning test I <sub>imp</sub> (10/350 μs) wire-wire/wire-PE/GND-PE	/ 1 kA /
Storage temperature	-40 °C...+80 °C
Ambient temperature (operational)	-40 °C...+70 °C
Protection degree	IP 20
UL 94 flammability rating	V-0

### Connection data

Type of connection	Screw connection, Torx® T15, Slotted 0.8 x 4
Tightening torque	0.5 Nm
Wire connection cross section, finely stranded, max.	4 mm <sup>2</sup>
Wire connection cross-section, finely stranded, min.	0.5 mm <sup>2</sup>
Wire cross-section, solid, max.	6 mm <sup>2</sup>
Wire cross-section, solid, min.	0.5 mm <sup>2</sup>
Wire cross-section, stranded, max.	4 mm <sup>2</sup>
Wire cross-section, stranded, min.	0.5 mm <sup>2</sup>
Stripping length	10 mm
Mounting rail	TS 35

### Failure probability

λges	54
MTTF	2114
SIL in compliance with IEC 61508	3

### Approvals

Approvals	CE; GOSTME25; OEVE; TUEV; UL; ROHS
Standards	IEC 61643-21

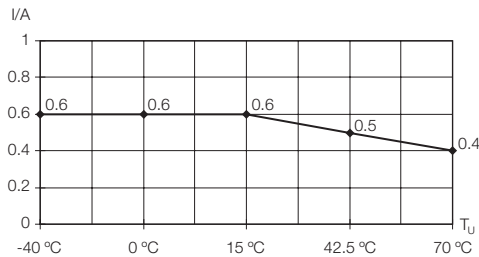

### Dimensions

Height x width x depth	mm	88.5 / 6.1 / 81
------------------------	----	-----------------

### Note

VSSC 6 SL and SL FG

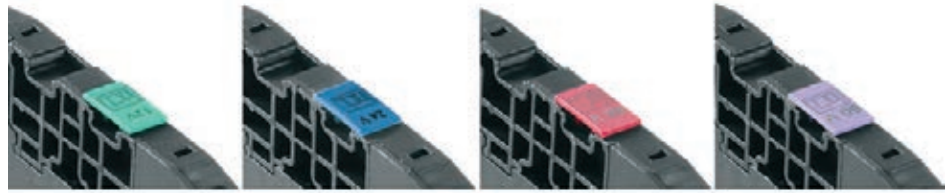

Lightning and surge protection for control and instrumentation signals



**Ordering data**

Rated voltage (AC)  
 Rated voltage (DC)  
 Max. continuous voltage, U<sub>c</sub> (AC)  
 Max. continuous voltage, U<sub>c</sub> (DC)  
 Rated current  
 Optical function display  
 Isolating function  
 Input attenuation  
 Pulse-reset capacity  
 Residual voltage, U<sub>r</sub> typical

	SL LD 12 V DC	SL LD 24 V UC	SL LD 48 V UC	SL LD 60 V UC
Rated voltage (AC)		24 V	48 V	60 V
Rated voltage (DC)	12 V	34 V	68 V	85 V
Max. continuous voltage, U <sub>c</sub> (AC)		30 V	60 V	75 V
Max. continuous voltage, U <sub>c</sub> (DC)	15 V	42 V	85 V	106 V
Rated current	500 mA	500 mA	500 mA	500 mA
Optical function display	Yes	Yes	Yes	Yes
Isolating function	No	No	No	No
Input attenuation	750 KHz	3.2 MHz	4.6 MHz	5.5 MHz
Pulse-reset capacity	≤ 20 ms	≤ 20 ms	≤ 20 ms	≤ 20 ms
Residual voltage, U <sub>r</sub> typical	74 V	110 V	174 V	222 V

**Ordering data**

Type  
 Order No.  
 Qty.

VSSC6SL LD 12VDC/0.5A	VSSC6SL LD24VAC/DC0.5A	VSSC6SL LD48VAC/DC0.5A	VSSC6SL LD60VAC/DC0.5A
<b>1064340000</b>	<b>1064350000</b>	<b>1064360000</b>	<b>1064370000</b>
10 ST	10 ST	10 ST	10 ST
End plate AP VSSC6 1063110000	End plate AP VSSC6 1063110000	End plate AP VSSC6 1063110000	End plate AP VSSC6 1063110000

**Note**

**Ordering data**

Rated voltage (AC)  
 Rated voltage (DC)  
 Max. continuous voltage, U<sub>c</sub> (AC)  
 Max. continuous voltage, U<sub>c</sub> (DC)  
 Rated current  
 Optical function display  
 Isolating function  
 Input attenuation  
 Pulse-reset capacity  
 Residual voltage, U<sub>r</sub> typical

	SLFG LD 12 V DC	SLFG LD 24 V UC	SLFG LD 48 V UC	SLFG LD 60 V UC
Rated voltage (AC)		24 V	48 V	60 V
Rated voltage (DC)	12 V	34 V	68 V	85 V
Max. continuous voltage, U <sub>c</sub> (AC)		30 V	60 V	75 V
Max. continuous voltage, U <sub>c</sub> (DC)	15 V	42 V	85 V	106 V
Rated current	500 mA	200 mA	10 mA	1.5 mA
Optical function display	Yes	Yes	Yes	Yes
Isolating function	No	No	No	No
Input attenuation	750 KHz	3.2 MHz	4.6 MHz	5.5 MHz
Pulse-reset capacity	≤ 20 ms	≤ 20 ms	≤ 20 ms	≤ 20 ms
Residual voltage, U <sub>r</sub> typical	74 V	110 V	174 V	222 V

**Ordering data**

Type  
 Order No.  
 Qty.

VSSC6SL FG LD12VDC0.5A	VSSC6SLFGLD24VAC/DC0.5A	VSSC6SLFGLD48VAC/DC0.5A	VSSC6SLFGLD60VAC/DC0.5A
<b>1064420000</b>	<b>1064430000</b>	<b>1064440000</b>	<b>1064470000</b>
10 ST	10 ST	10 ST	10 ST
End plate AP VSSC6 1063110000	End plate AP VSSC6 1063110000	End plate AP VSSC6 1063110000	End plate AP VSSC6 1063110000

**Note**



**VARITECTOR SSC 6AN**

**VSSC 6 TR SL and TR SL FG - protection for floating signals with signal display**

- Two-stage surge protection with screw connection for measurement and control signals with signal display
- Surge protection in terminal block design
- Modular width of only 6.2 mm
- Space-saving design for two signals
- Torx® slotted screw connection
- Can be used in compliance with installation standard IEC 62305
- Tested in accordance with IEC 61643-21: D1, C2, C3
- Integrated PE foot, safely discharges up to 20 kA (8/20 μs) and 2.5 kA (10/350 μs) to PE

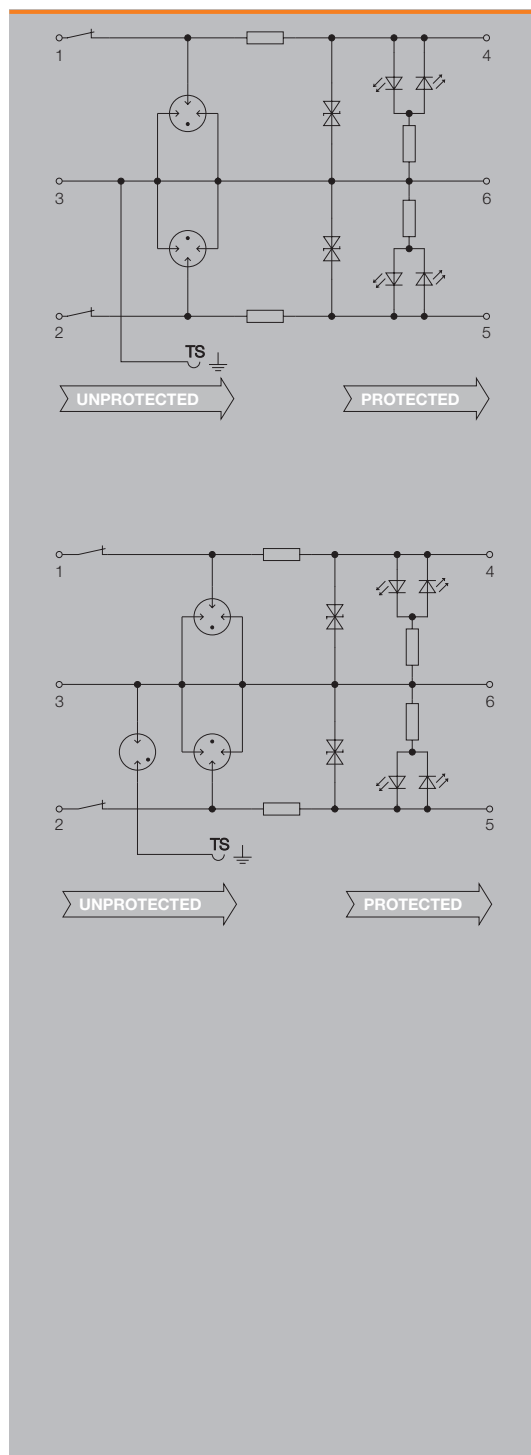

**Technical data**

Rated current	500 mA
Dielectric strength at FG against PE	≥ 500 V
Volume resistance	1.8 Ω 10 %
Overload - failure mode	Modus 2
Requirements category acc. to IEC 61643-21	C2, C3, D1
Standards	IEC 61643-21
Surge current-carrying capacity C1	
Surge current-carrying capacity C2	2.5 kA 8/20 μs 5 kV 1.2/50 μs
Surge current-carrying capacity C3	10 A 10/1000 μs
Surge current-carrying capacity D1	1 kA 10/350 μs
Discharge current I <sub>d</sub> (8/20 μs) wire-wire/wire-PE/GND-PE	/ 2.5 kA /
Discharge I <sub>max</sub> (8/20 μs) wire-wire/wire-PE/GND-PE	/ 10 kA /
Lightning test I <sub>imp</sub> (10/350 μs) wire-wire/wire-PE/GND-PE	/ 1 kA /
Storage temperature	-40 °C...+80 °C
Ambient temperature (operational)	-40 °C...+70 °C
Protection degree	IP 20
UL 94 flammability rating	V-0

**Connection data**

Type of connection	Screw connection, Torx® T15, Slotted 0.8 x 4
Tightening torque	0.5 Nm
Wire connection cross section, finely stranded, max.	4 mm <sup>2</sup>
Wire connection cross-section, finely stranded, min.	0.5 mm <sup>2</sup>
Wire cross-section, solid, max.	6 mm <sup>2</sup>
Wire cross-section, solid, min.	0.5 mm <sup>2</sup>
Wire cross-section, stranded, max.	4 mm <sup>2</sup>
Wire cross-section, stranded, min.	0.5 mm <sup>2</sup>
Stripping length	10 mm
Mounting rail	TS 35

**Failure probability**

λges	54
MTTF	2114
SIL in compliance with IEC 61508	3

**Approvals**

Approvals	CE; OEVE; TUEV; UL; ROHS
Standards	IEC 61643-21

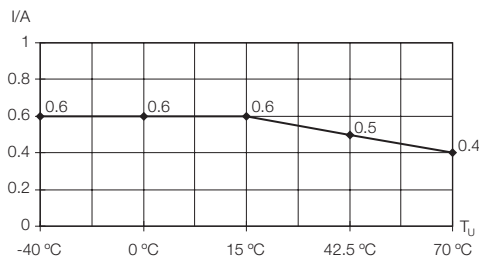

**Dimensions**

Height x width x depth	mm	88.5 / 6.1 / 81
------------------------	----	-----------------

**Note**

## VSSC 6 TR SL and TR CL FG

## Ordering data

	TR SL LD 12 V DC	TR SL LD 24 V UC	TR SL LD 48 V UC	TR SL LD 60 V UC
Rated voltage (AC)		24 V	48 V	60 V
Rated voltage (DC)	12 V	34 V	68 V	85 V
Max. continuous voltage, U <sub>c</sub> (AC)		30 V	60 V	75 V
Max. continuous voltage, U <sub>c</sub> (DC)	15 V	42 V	85 V	106 V
Rated current	500 mA	500 mA	500 mA	500 mA
Optical function display	Yes	Yes	Yes	Yes
Isolating function	Yes	Yes	Yes	Yes
Input attenuation	750 KHz	3.2 MHz	4.6 MHz	5.5 MHz
Pulse-reset capacity	≤ 20 ms	≤ 20 ms	≤ 20 ms	≤ 20 ms
Residual voltage, U <sub>r</sub> typical	74 V	110 V	174 V	222 V

## Ordering data

	TR SL LD 12 V DC	TR SL LD 24 V UC	TR SL LD 48 V UC	TR SL LD 60 V UC
Type	VSSC6TRSLLD12VDC0.5A	VSSC6TRSLLD24VAC/DC0.5A	VSSC6TRSLLD48VAC/DC0.5A	VSSC6TRSLLD60VAC/DC0.5A
Order No.	<b>1064380000</b>	<b>1064390000</b>	<b>1064400000</b>	<b>1064410000</b>
Qty.	10 ST	10 ST	10 ST	10 ST
Note	End plate AP VSSC6 1063110000	End plate AP VSSC6 1063110000	End plate AP VSSC6 1063110000	End plate AP VSSC6 1063110000

## Ordering data

	TR SLFG LD 12 V DC	TR SLFG LD 24 V UC	TR SLFG LD 48 V UC	TR SLFG LD 60 V UC
Rated voltage (AC)		24 V	48 V	60 V
Rated voltage (DC)	12 V	34 V	68 V	85 V
Max. continuous voltage, U <sub>c</sub> (AC)		30 V	60 V	75 V
Max. continuous voltage, U <sub>c</sub> (DC)	15 V	42 V	85 V	106 V
Rated current	500 mA	200 mA	10 mA	1.5 mA
Optical function display	Yes	Yes	Yes	Yes
Isolating function	Yes	Yes	Yes	Yes
Input attenuation	750 KHz	3.2 MHz	4.6 MHz	5.5 MHz
Pulse-reset capacity	≤ 20 ms	≤ 20 ms	≤ 20 ms	≤ 20 ms
Residual voltage, U <sub>r</sub> typical	74 V	110 V	174 V	222 V

## Ordering data

	TR SLFG LD 12 V DC	TR SLFG LD 24 V UC	TR SLFG LD 48 V UC	TR SLFG LD 60 V UC
Type	VSSC6TRSLFGLD12VDC0.5A	VSSC6TRSLFGLD24VUC 0.5A	VSSC6TRSLFGLD48VUC 0.5A	VSSC6TRSLFGLD60VUC 0.5A
Order No.	<b>1064490000</b>	<b>1064500000</b>	<b>1064510000</b>	<b>1064520000</b>
Qty.	10 ST	10 ST	10 ST	10 ST
Note	End plate AP VSSC6 1063110000	End plate AP VSSC6 1063110000	End plate AP VSSC6 1063110000	End plate AP VSSC6 1063110000



**VARITECTOR SSC 6AN**

**VSSC 6 MOV - protection with Varistor (MOV)**

- One-stage surge protection with screw connection for measurement and control signals
- Surge protection in terminal block design
- Modular width of only 6.2 mm
- Space-saving design for two signals
- Torx® slotted screw connection
- Can be used in compliance with installation standard IEC 62305
- Tested in accordance with IEC 61643-21: C1, C2
- Integrated PE foot, safely discharges up to 20 kA (8/20 μs) and 2.5 kA (10/350 μs) to PE

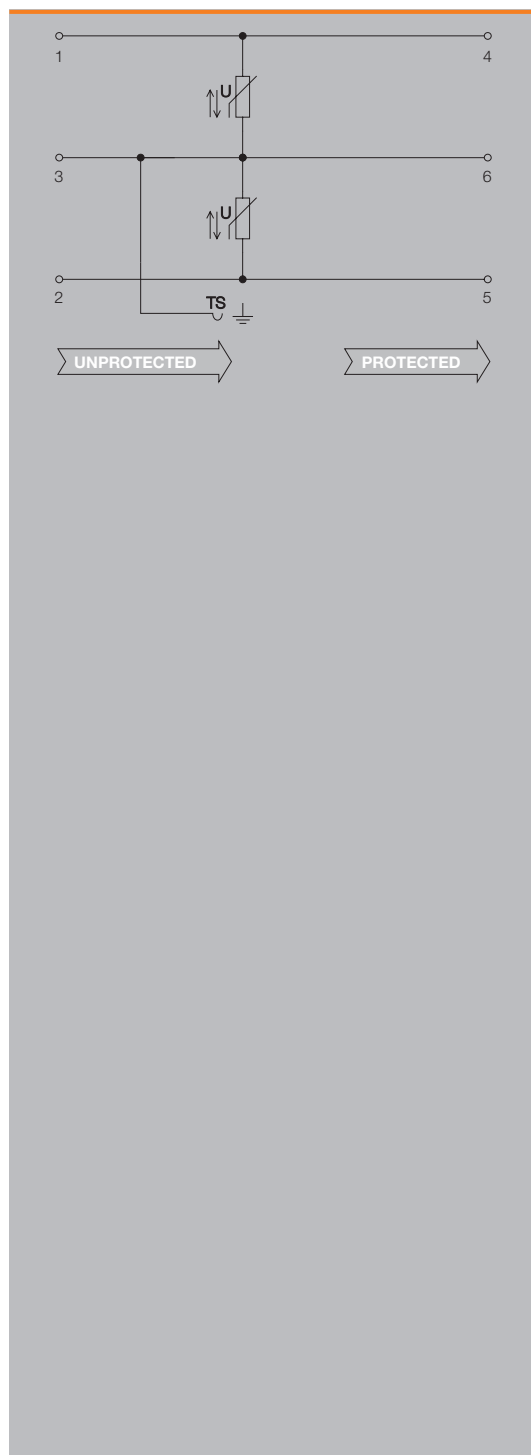
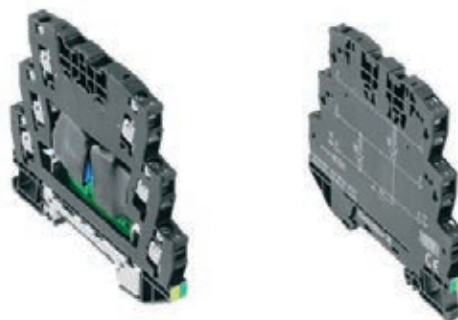

**Technical data**

Rated current	12 A
Dielectric strength at FG against PE	
Volume resistance	< 0.1 Ω
Overload - failure mode	Mode 1
Requirements category acc. to IEC 61643-21	C1
Standards	According to IEC61643-21
Surge current-carrying capacity C1	0.25 kA 8/20 μs 0.5 kV 1.2/50 μs
Surge current-carrying capacity C2	
Surge current-carrying capacity C3	
Surge current-carrying capacity D1	
Discharge current I <sub>d</sub> (8/20 μs) wire-wire/wire-PE/GND-PE	/ 0.5 kA /
Discharge I <sub>max</sub> (8/20 μs) wire-wire/wire-PE/GND-PE	/ 1 kA /
Lightning test I <sub>imp</sub> (10/350 μs) wire-wire/wire-PE/GND-PE	
Storage temperature	-40 °C...+80 °C
Ambient temperature (operational)	-40 °C...+70 °C
Protection degree	IP 20
UL 94 flammability rating	V-0
<b>Connection data</b>	
Type of connection	Screw connection, Torx® T15, Slotted 0.8 x 4
Tightening torque	0.5 Nm
Wire connection cross section, finely stranded, max.	4 mm <sup>2</sup>
Wire connection cross-section, finely stranded, min.	0.5 mm <sup>2</sup>
Wire cross-section, solid, max.	6 mm <sup>2</sup>
Wire cross-section, solid, min.	0.5 mm <sup>2</sup>
Wire cross-section, stranded, max.	4 mm <sup>2</sup>
Wire cross-section, stranded, min.	0.5 mm <sup>2</sup>
Stripping length	10 mm
Mounting rail	TS 35
<b>Failure probability</b>	
λges	26
MTTF	4391
SIL in compliance with IEC 61508	3
<b>Approvals</b>	
Approvals	CE; GOSTME25; OEVE; TUEV; UL; ROHS
Standards	According to IEC61643-21
Height x depth	

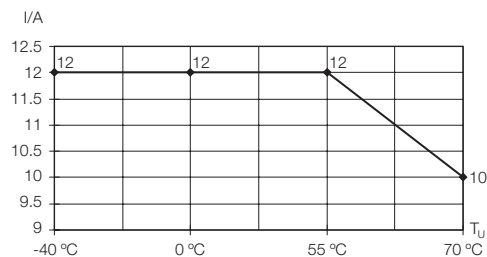

**Dimensions**

Height x depth mm 88.5 / 81

**Note**

VSSC 6 MOV

Ordering data

	MOV 12 V DC	MOV 24 V UC	MOV 48 V UC	MOV 60 V UC
Rated voltage (AC)		24 V	48 V	60 V
Rated voltage (DC)	12 V	34 V	60 V	85 V
Max. continuous voltage, U <sub>c</sub> (AC)		30 V	60 V	75 V
Max. continuous voltage, U <sub>c</sub> (DC)	15 V	42 V	85 V	106 V
Rated current	12 A	12 A	12 A	12 A
Optical function display	No	No	No	No
Isolating function	No	No	No	No
Input attenuation				
Pulse-reset capacity				
Residual voltage, U <sub>r</sub> typical	57 V	120 V	213 V	269 V
Capacitance	10.8 nF	4.6 nF	2.0 nF	1.78 nF
Width	7.1	7.1	7.1	7.1

Ordering data	VSSC6 MOV 12VDC	VSSC6 MOV 24VAC/DC	VSSC6 MOV 48VAC/DC	VSSC6 MOV 60VAC/DC
Type	VSSC6 MOV 12VDC	VSSC6 MOV 24VAC/DC	VSSC6 MOV 48VAC/DC	VSSC6 MOV 60VAC/DC
Order No.	<b>1064530000</b>	<b>1064540000</b>	<b>1064570000</b>	<b>1064600000</b>
Qty.	8 ST	8 ST	8 ST	8 ST
Note	End plate AP VSSC6 1063110000	End plate AP VSSC6 1063110000	End plate AP VSSC6 1063110000	End plate AP VSSC6 1063110000

Ordering data

	MOV 120 V UC	MOV 150 V UC	MOV 240 V UC
Rated voltage (AC)	120 V	150 V	240 V
Rated voltage (DC)	170 V	212 V	339 V
Max. continuous voltage, U <sub>c</sub> (AC)	150 V	188 V	288 V
Max. continuous voltage, U <sub>c</sub> (DC)	212 V	266 V	407 V
Rated current	12 A	12 A	12 A
Optical function display	No	No	No
Isolating function	No	No	No
Input attenuation			
Pulse-reset capacity			
Residual voltage, U <sub>r</sub> typical	543 V	641 V	1022 V
Capacitance	283 pF	0.8 nF	0.5 nF
Width	12.2	12.2	12.2

Ordering data	VSSC6 MOV 120VAC/DC	VSSC6 MOV 150VAC/DC	VSSC6 MOV 240VAC/DC
Type	VSSC6 MOV 120VAC/DC	VSSC6 MOV 150VAC/DC	VSSC6 MOV 240VAC/DC
Order No.	<b>1064610000</b>	<b>1064620000</b>	<b>1064630000</b>
Qty.	5 ST	5 ST	5 ST
Note	End plate AP VSSC6 1063110000	End plate AP VSSC6 1063110000	End plate AP VSSC6 1063110000



## VARITECTOR SSC 6AN

### VSSC 6 TR LD MOV - protection with varistor (MOV)

- One-stage surge protection with screw connection for measurement and control signals
- Surge protection in terminal block design
- Modular width of only 6.2 mm
- Space-saving design for two signals
- Torx® slotted screw connection
- Can be used in compliance with installation standard IEC 62305
- Tested in accordance with IEC 61643-21: C1, C2
- Integrated PE foot, safely discharges up to 20 kA (8/20 μs) and 2.5 kA (10/350 μs) to PE

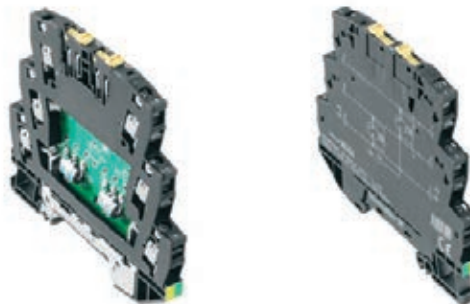

**B**

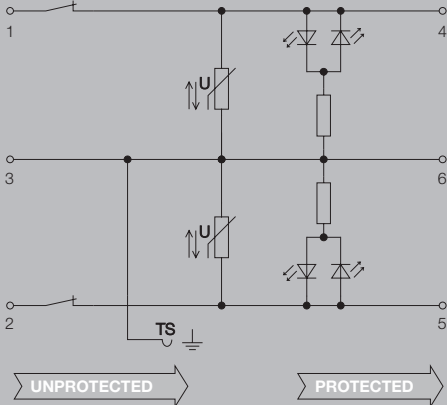

### Technical data

Rated current	12 A
Dielectric strength at FG against PE	
Volume resistance	< 0.1 Ω
Overload - failure mode	Mode 1
Requirements category acc. to IEC 61643-21	C1
Standards	IEC 61643-21
Surge current-carrying capacity C1	0.25 kA 8/20 μs 0.5 kV 1.2/50 μs
Surge current-carrying capacity C2	
Surge current-carrying capacity C3	
Surge current-carrying capacity D1	
Discharge current $I_t$ (8/20 μs) wire-wire/wire-PE/GND-PE	/ 0.5 kA /
Discharge $I_{max}$ (8/20 μs) wire-wire/wire-PE/GND-PE	/ 1 kA /
Lightning test $I_{imp}$ (10/350 μs) wire-wire/wire-PE/GND-PE	
Storage temperature	-40 °C...+80 °C
Ambient temperature (operational)	-40 °C...+70 °C
Protection degree	IP 20
UL 94 flammability rating	V-0
<b>Connection data</b>	
Type of connection	Screw connection, Torx® T15, Slotted 0.8 x 4
Tightening torque	0.5 Nm
Wire connection cross section, finely stranded, max.	4 mm <sup>2</sup>
Wire connection cross-section, finely stranded, min.	0.5 mm <sup>2</sup>
Wire cross-section, solid, max.	6 mm <sup>2</sup>
Wire cross-section, solid, min.	0.5 mm <sup>2</sup>
Wire cross-section, stranded, max.	4 mm <sup>2</sup>
Wire cross-section, stranded, min.	0.5 mm <sup>2</sup>
Stripping length	10 mm
Mounting rail	TS 35
<b>Failure probability</b>	
λges	37
MTTF	3085
SIL in compliance with IEC 61508	3
<b>Approvals</b>	
Approvals	CE; GOSTME25; OEVE; TUEV; UL; ROHS
Standards	IEC 61643-21

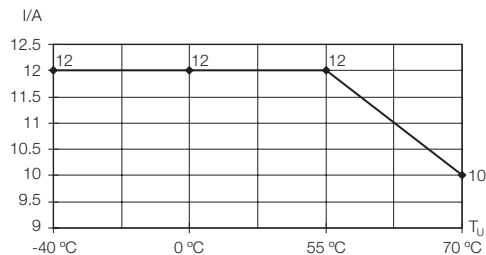

### Dimensions

Height x depth mm 88.5 / 81

### Note

VSSC 6 TR LD MOV

Ordering data

	TR LD MOV 12 V DC	TR LD MOV 24 V UC	TR LD MOV 48 V UC	TR LD MOV 60 V UC
Rated voltage (AC)		24 V	48 V	60 V
Rated voltage (DC)	12 V	34 V	68 V	85 V
Max. continuous voltage, U <sub>c</sub> (AC)		30 V	60 V	75 V
Max. continuous voltage, U <sub>c</sub> (DC)	15 V	42 V	85 V	106 V
Rated current	12 A	12 A	12 A	12 A
Optical function display	Yes	Yes	Yes	Yes
Isolating function	Yes	Yes	Yes	Yes
Input attenuation				
Pulse-reset capacity				
Residual voltage, U <sub>r</sub> typical	57 V	120 V	213 V	269 V
Capacitance	10.8 nF	4.6 nF	2.0 nF	1.78 nF
Width	7.1	7.1	7.1	7.1

Ordering data	VSSC6 TRLDMOV 12VDC	VSSC6 TRLDMOV 24VAC/DC	VSSC6 TRLDMOV 48VAC/DC	VSSC6 TRLDMOV60VAC/DC
Type	VSSC6 TRLDMOV 12VDC	VSSC6 TRLDMOV 24VAC/DC	VSSC6 TRLDMOV 48VAC/DC	VSSC6 TRLDMOV60VAC/DC
Order No.	<b>1064800000</b>	<b>1064810000</b>	<b>1064820000</b>	<b>1064830000</b>
Qty.	8 ST	8 ST	8 ST	8 ST
Note	End plate AP VSSC6 1063110000	End plate AP VSSC6 1063110000	End plate AP VSSC6 1063110000	End plate AP VSSC6 1063110000

Ordering data

	TR LD MOV 120 V UC	TR LD MOV 150 V UC	TR LD MOV 240 V UC
Rated voltage (AC)	120 V	150 V	240 V
Rated voltage (DC)	170 V	212 V	339 V
Max. continuous voltage, U <sub>c</sub> (AC)	150 V	188 V	288 V
Max. continuous voltage, U <sub>c</sub> (DC)	212 V	266 V	407 V
Rated current	12 A	12 A	12 A
Optical function display	Yes	Yes	Yes
Isolating function	Yes	Yes	Yes
Input attenuation			
Pulse-reset capacity			
Residual voltage, U <sub>r</sub> typical	543 V	641 V	1022 V
Capacitance	283 pF	0.8 nF	0.5 nF
Width	12.2	12.2	12.2

Ordering data	VSSC6 TRLDMOV120VAC/DC	VSSC6 TRLDMOV150VAC/DC	VSSC6 TRLDMOV240VAC/DC
Type	VSSC6 TRLDMOV120VAC/DC	VSSC6 TRLDMOV150VAC/DC	VSSC6 TRLDMOV240VAC/DC
Order No.	<b>1064840000</b>	<b>1064850000</b>	<b>1064860000</b>
Qty.	5 ST	5 ST	5 ST
Note	End plate AP VSSC6 1063110000	End plate AP VSSC6 1063110000	End plate AP VSSC6 1063110000



## VARITECTOR SSC 6AN

### VSSC 6 GDT - protection with sparkover gap (GDT)

- One-stage surge protection with screw connection for measurement and control signals
- Surge protection in terminal block design
- Modular width of only 12.4 mm
- Space-saving design for two signals
- Torx® slotted screw connection
- Can be used in compliance with installation standard IEC 62305
- Tested in accordance with IEC 61643-21: D1, C2, C3
- Integrated PE foot, safely discharges up to 20 kA (8/20 µs) and 2.5 kA (10/350 µs) to PE

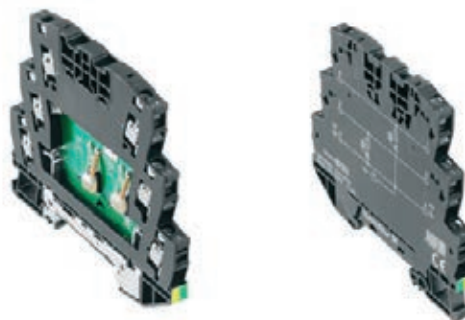

**B**

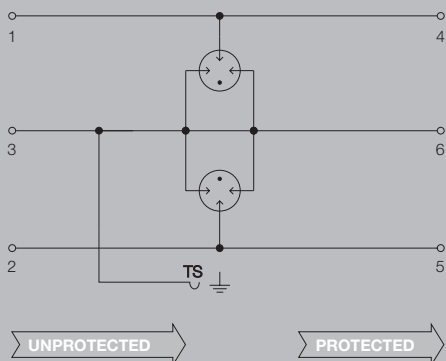

### Technical data

Rated current	12 A
Dielectric strength at FG against PE	
Volume resistance	< 0.1 Ω
Overload - failure mode	Modus 2
Requirements category acc. to IEC 61643-21	C2, C3, D1
Standards	IEC 61643-21
Surge current-carrying capacity C1	
Surge current-carrying capacity C2	2.5 kA 8/20 µs 5 kV 1.2/50 µs
Surge current-carrying capacity C3	50 A 10/1000 µs
Surge current-carrying capacity D1	1 kA 10/350 µs
Discharge current $I_t$ (8/20 µs) wire-wire/wire-PE/GND-PE	/ 2.5 kA /
Discharge $I_{max}$ (8/20 µs) wire-wire/wire-PE/GND-PE	/ 10 kA /
Lightning test $I_{imp}$ (10/350 µs) wire-wire/wire-PE/GND-PE	/ 1 kA /
Storage temperature	-40 °C...+80 °C
Ambient temperature (operational)	-40 °C...+70 °C
Protection degree	IP 20
UL 94 flammability rating	V-0
<b>Connection data</b>	
Type of connection	Screw connection, Torx® T15, Slotted 0.8 x 4
Tightening torque	0.5 Nm
Wire connection cross section, finely stranded, max.	4 mm <sup>2</sup>
Wire connection cross-section, finely stranded, min.	0.5 mm <sup>2</sup>
Wire cross-section, solid, max.	6 mm <sup>2</sup>
Wire cross-section, solid, min.	0.5 mm <sup>2</sup>
Wire cross-section, stranded, max.	4 mm <sup>2</sup>
Wire cross-section, stranded, min.	0.5 mm <sup>2</sup>
Stripping length	10 mm
Mounting rail	TS 35
<b>Failure probability</b>	
λges	10
MTTF	11416
SIL in compliance with IEC 61508	3
<b>Approvals</b>	
Approvals	CE; GOSTME25; TUEV; ROHS
Standards	IEC 61643-21

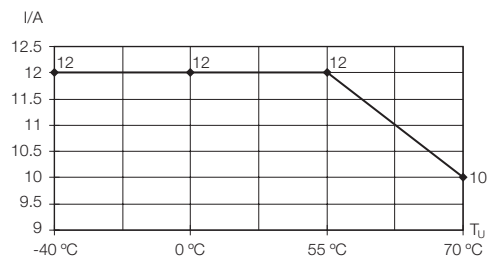

### Dimensions

Height x width x depth mm 88.5 / 6.1 / 81

### Note

VSSC 6 GDT

Ordering data

	GDT 24 V UC 10 kA	GDT 110 V UC 10 kA	GDT 240 V UC 10 kA	GDT 24 V UC 20 kA
Rated voltage (AC)	24 V	110 V	240 V	24 V
Rated voltage (DC)	34 V	156 V	339 V	34 V
Max. continuous voltage, U <sub>c</sub> (AC)	30 V	138 V	288 V	30 V
Max. continuous voltage, U <sub>c</sub> (DC)	42 V	195 V	407 V	42 V
Rated current	12 A	12 A	12 A	12 A
Optical function display	No	No	No	No
Isolating function	No	No	No	No
Input attenuation				
Pulse-reset capacity				
Residual voltage, U <sub>r</sub> typical	976 V	1153 V	1792 V	949 V
Capacitance	1.5 nF	4.2 nF	3.0 nF	5.3 nF

Ordering data				
Type	VSSC6 GDT 24VAC/DC 10kA	VSSC6 GDT 110VAC/DC10kA	VSSC6 GDT 240VAC/DC10kA	VSSC6 GDT 24VAC/DC 20kA
Order No.	<b>1064640000</b>	<b>1064690000</b>	<b>1064710000</b>	<b>1064670000</b>
Qty.	10 ST	10 ST	5 ST	5 ST
Note	End plate AP VSSC6 1063110000	End plate AP VSSC6 1063110000	End plate AP VSSC6 1063110000	End plate AP VSSC6 1063110000

Ordering data

	GDT 110 V UC 20 kA	GDT 240 V UC 20 kA
Rated voltage (AC)	110 V	240 V
Rated voltage (DC)	156 V	339 V
Max. continuous voltage, U <sub>c</sub> (AC)	138 V	288 V
Max. continuous voltage, U <sub>c</sub> (DC)	195 V	407 V
Rated current	12 A	12 A
Optical function display	No	No
Isolating function	No	No
Input attenuation		
Pulse-reset capacity		
Residual voltage, U <sub>r</sub> typical	992 V	1288 V
Capacitance	2.5 nF	2.4 nF

Ordering data		
Type	VSSC6 GDT 110VAC/DC20kA	VSSC6 GDT 240VAC/DC20kA
Order No.	<b>1064700000</b>	<b>1064720000</b>
Qty.	5 ST	5 ST
Note	End plate AP VSSC6 1063110000	End plate AP VSSC6 1063110000



## VARITECTOR SSC 6AN

### VSSC 6 TR GDT - protection with sparkover gap (GDT)

- One-stage surge protection with screw connection for measurement and control signals
- Surge protection in terminal block design
- Modular width of only 6.2 mm or 12.4 mm
- Space-saving design for two signals
- Torx® slotted screw connection
- Can be used in compliance with installation standard IEC 62305
- Tested in accordance with IEC 61643-21: D1, C2, C3
- Integrated PE foot, safely discharges up to 20 kA (8/20 μs) and 2.5 kA (10/350 μs) to PE

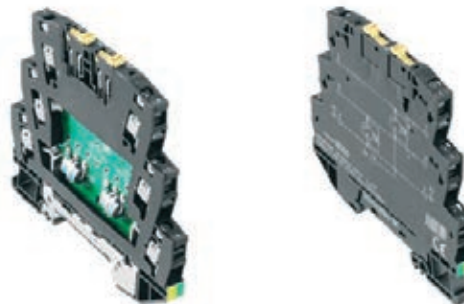

## B

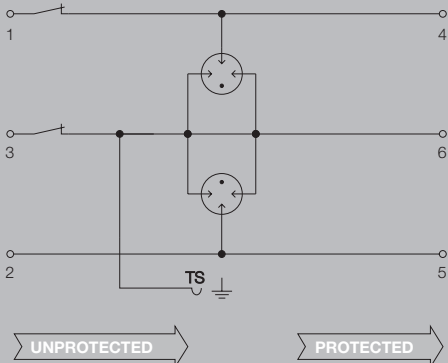

### Technical data

Rated current	12 A
Dielectric strength at FG against PE	
Volume resistance	< 0.1 Ω
Overload - failure mode	Modus 2
Requirements category acc. to IEC 61643-21	C2, C3, D1
Standards	IEC 61643-21
Surge current-carrying capacity C1	
Surge current-carrying capacity C2	2.5 kA 8/20 μs 5 kV 1.2/50 μs
Surge current-carrying capacity C3	50 A 10/1000 μs
Surge current-carrying capacity D1	1 kA 10/350 μs
Discharge current $I_t$ (8/20 μs) wire-wire/wire-PE/GND-PE	/ 2.5 kA /
Discharge $I_{max}$ (8/20 μs) wire-wire/wire-PE/GND-PE	/ 10 kA /
Lightning test $I_{imp}$ (10/350 μs) wire-wire/wire-PE/GND-PE	/ 1 kA /
Storage temperature	-40 °C...+80 °C
Ambient temperature (operational)	-40 °C...+80 °C
Protection degree	IP 20
UL 94 flammability rating	V-0
<b>Connection data</b>	
Type of connection	Screw connection, Torx® T15, Slotted 0.8 x 4
Tightening torque	0.5 Nm
Wire connection cross section, finely stranded, max.	4 mm <sup>2</sup>
Wire connection cross-section, finely stranded, min.	0.5 mm <sup>2</sup>
Wire cross-section, solid, max.	6 mm <sup>2</sup>
Wire cross-section, solid, min.	0.5 mm <sup>2</sup>
Wire cross-section, stranded, max.	4 mm <sup>2</sup>
Wire cross-section, stranded, min.	0.5 mm <sup>2</sup>
Stripping length	10 mm
Mounting rail	TS 35
<b>Failure probability</b>	
λges	10
MTTF	11416
SIL in compliance with IEC 61508	3
<b>Approvals</b>	
Approvals	CE; GOSTME25; TUEV; ROHS
Standards	IEC 61643-21

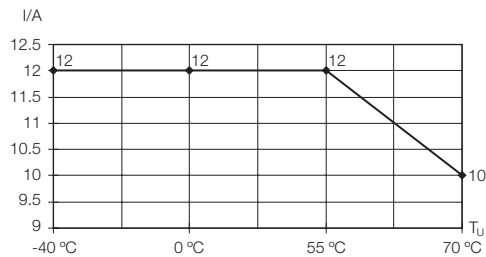

### Dimensions

Height x width x depth mm 88.5 / 6.1 / 81

### Note

VSSC 6 TR GDT

Ordering data

	TR GDT 24 V UC 10 kA	TR GDT 110 V UC 10 kA	TR GDT 240 V UC 10 kA
Rated voltage (AC)	24 V	110 V	240 V
Rated voltage (DC)	34 V	156 V	339 V
Max. continuous voltage, U <sub>c</sub> (AC)	30 V	138 V	288 V
Max. continuous voltage, U <sub>c</sub> (DC)	42 V	195 V	407 V
Rated current	12 A	12 A	12 A
Optical function display	No	No	No
Isolating function	Yes	Yes	Yes
Input attenuation			
Pulse-reset capacity			
Residual voltage, U <sub>r</sub> typical	976 V	1153 V	1792 V
Capacitance	1.5 nF	4.2 nF	3.0 nF

Ordering data			
Type	VSSC6TRGDT24VAC/DC10kA	VSSC6TRGDT110VAC/DC10kA	VSSC6TRGDT240VAC/DC10kA
Order No.	<b>1064870000</b>	<b>1064890000</b>	<b>1064920000</b>
Qty.	10 ST	10 ST	5 ST
Note	End plate AP VSSC6 1063110000	End plate AP VSSC6 1063110000	End plate AP VSSC6 1063110000



## VARITECTOR SSC 6AN

### VSSC 6 TAZ and TR TAZ - suppressor diode, with and without isolation option (TR)

- Two-stage surge protection with screw connection for PROFIBUS RS422/485 data interfaces
- Surge protection in terminal block design
- Modular width of only 6.2 mm
- Space-saving design: 1 signal
- Torx® slotted screw connection
- Can be used in compliance with installation standard IEC 62305
- Tested in accordance with IEC 61643-21: D1, C2, C3
- Integrated PE foot, safely discharges up to 20 kA (8/20 μs) and 2.5 kA (10/350 μs) to PE

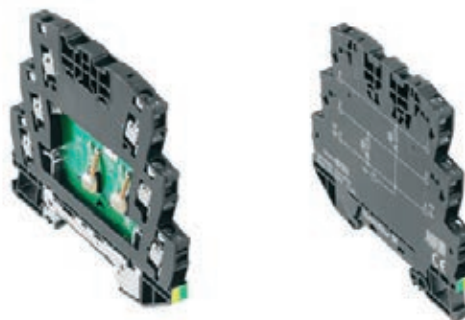

**B**

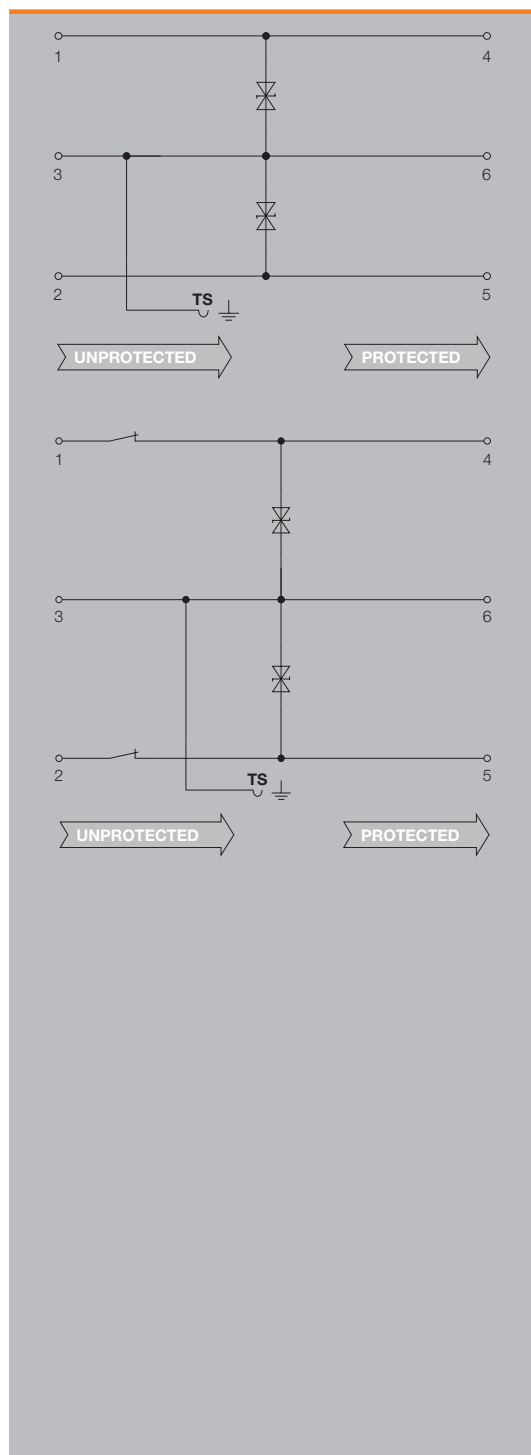

### Technical data

Rated current	12 A
Dielectric strength at FG against PE	
Volume resistance	< 0.1 Ω
Overload - failure mode	Mode 1
Requirements category acc. to IEC 61643-21	C3
Standards	According to IEC61643-21
Surge current-carrying capacity C1	
Surge current-carrying capacity C2	
Surge current-carrying capacity C3	50 A 10/1000 μs
Surge current-carrying capacity D1	
Discharge current $I_t$ (8/20 μs) wire-wire/wire-PE/GND-PE	/ 0.2 kA /
Discharge $I_{max}$ (8/20 μs) wire-wire/wire-PE/GND-PE	/ 0.5 kA /
Lightning test $I_{imp}$ (10/350 μs) wire-wire/wire-PE/GND-PE	
Storage temperature	-40 °C...+80 °C
Ambient temperature (operational)	-40 °C...+70 °C
Protection degree	IP 20
UL 94 flammability rating	V-0
<b>Connection data</b>	
Type of connection	Screw connection, Torx® T15, Slotted 0.8 x 4
Tightening torque	0.5 Nm
Wire connection cross section, finely stranded, max.	4 mm <sup>2</sup>
Wire connection cross-section, finely stranded, min.	0.5 mm <sup>2</sup>
Wire cross-section, solid, max.	6 mm <sup>2</sup>
Wire cross-section, solid, min.	0.5 mm <sup>2</sup>
Wire cross-section, stranded, max.	4 mm <sup>2</sup>
Wire cross-section, stranded, min.	0.5 mm <sup>2</sup>
Stripping length	10 mm
Mounting rail	TS 35
<b>Failure probability</b>	
λges	32
MTTF	3567
SIL in compliance with IEC 61508	3
<b>Approvals</b>	
Approvals	CE; GOSTME25; OEVE; TUEV; UL; ROHS
Standards	According to IEC61643-21

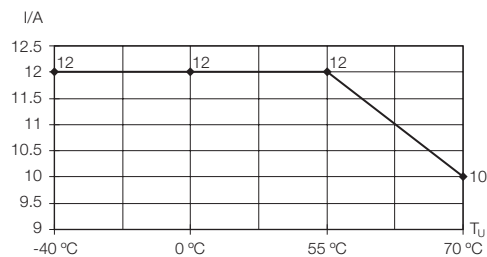

### Dimensions

Height x width x depth mm 88.5 / 6.1 / 81

### Note

## VSSC 6 TAZ and TR LD TAZ

## Ordering data

	TAZ 12 V DC	TAZ 24 V UC	TAZ 48 V UC	TAZ 60 V UC
Rated voltage (AC)		24 V	48 V	60 V
Rated voltage (DC)	12 V	34 V	68 V	85 V
Max. continuous voltage, U <sub>c</sub> (AC)		30 V	60 V	75 V
Max. continuous voltage, U <sub>c</sub> (DC)	15 V	42 V	85 V	106 V
Rated current	12 A	12 A	12 A	12 A
Optical function display	No	No	No	No
Isolating function	No	No	No	No
Residual voltage, U <sub>r</sub> typical	26 V	62 V	85 V	100 V
Capacitance	4.9 pF	0.8 nF	0.4 nF	0.3 nF

## Ordering data

	VSSC6 TAZ 12VDC	VSSC6 TAZ 24VAC/DC	VSSC6 TAZ 48VAC/DC	VSSC6 TAZ 60VAC/DC
Type	VSSC6 TAZ 12VDC	VSSC6 TAZ 24VAC/DC	VSSC6 TAZ 48VAC/DC	VSSC6 TAZ 60VAC/DC
Order No.	<b>1064730000</b>	<b>1064740000</b>	<b>1064770000</b>	<b>1064790000</b>
Qty.	10 ST	10 ST	10 ST	10 ST
Note	End plate AP VSSC6 1063110000	End plate AP VSSC6 1063110000	End plate AP VSSC6 1063110000	End plate AP VSSC6 1063110000

## Ordering data

	TR LD TAZ 12 V DC	TR LD TAZ 24 V UC	TR LD TAZ 48 V UC	TR LD TAZ 60 V UC
Rated voltage (AC)		24 V	48 V	60 V
Rated voltage (DC)	12 V	34 V	68 V	85 V
Max. continuous voltage, U <sub>c</sub> (AC)		30 V	60 V	75 V
Max. continuous voltage, U <sub>c</sub> (DC)	15 V	42 V	85 V	106 V
Rated current	12 A	12 A	12 A	12 A
Optical function display	Yes	Yes	Yes	Yes
Isolating function	Yes	Yes	Yes	Yes
Residual voltage, U <sub>r</sub> typical	26 V	62 V	85 V	100 V
Capacitance	4.8 nF	0.8 nF	0.4 nF	0.3 nF

## Ordering data

	VSSC6 TRLDTAZ 12VDC	VSSC6 TRLDTAZ 24VAC/DC	VSSC6 TRLDTAZ 48VAC/DC	VSSC6 TRLDTAZ 60VAC/DC
Type	VSSC6 TRLDTAZ 12VDC	VSSC6 TRLDTAZ 24VAC/DC	VSSC6 TRLDTAZ 48VAC/DC	VSSC6 TRLDTAZ 60VAC/DC
Order No.	<b>1064940000</b>	<b>1064950000</b>	<b>1064960000</b>	<b>1064970000</b>
Qty.	10 ST	10 ST	10 ST	10 ST
Note	End plate AP VSSC6 1063110000	End plate AP VSSC6 1063110000	End plate AP VSSC6 1063110000	End plate AP VSSC6 1063110000

## VARITECTOR SSC 6AN

### VSSC 6 RS485 - protection for RS232/RS485 signal interfaces

- Two-stage surge protection with screw connection for RS422/RS485 data interfaces
- Surge protection in terminal block design
- Modular width of only 6.2 mm
- Space-saving design: 1 signal
- Torx® slotted screw connection
- Can be used in compliance with installation standard IEC 62305
- Tested in accordance with IEC 61643-21: D1, C2, C3
- Integrated PE foot, safely discharges up to 20 kA (8/20 μs) and 2.5 kA (10/350 μs) to PE



Similar to illustration

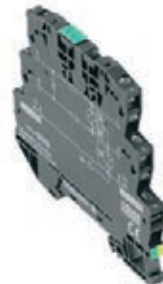

Similar to illustration

## B

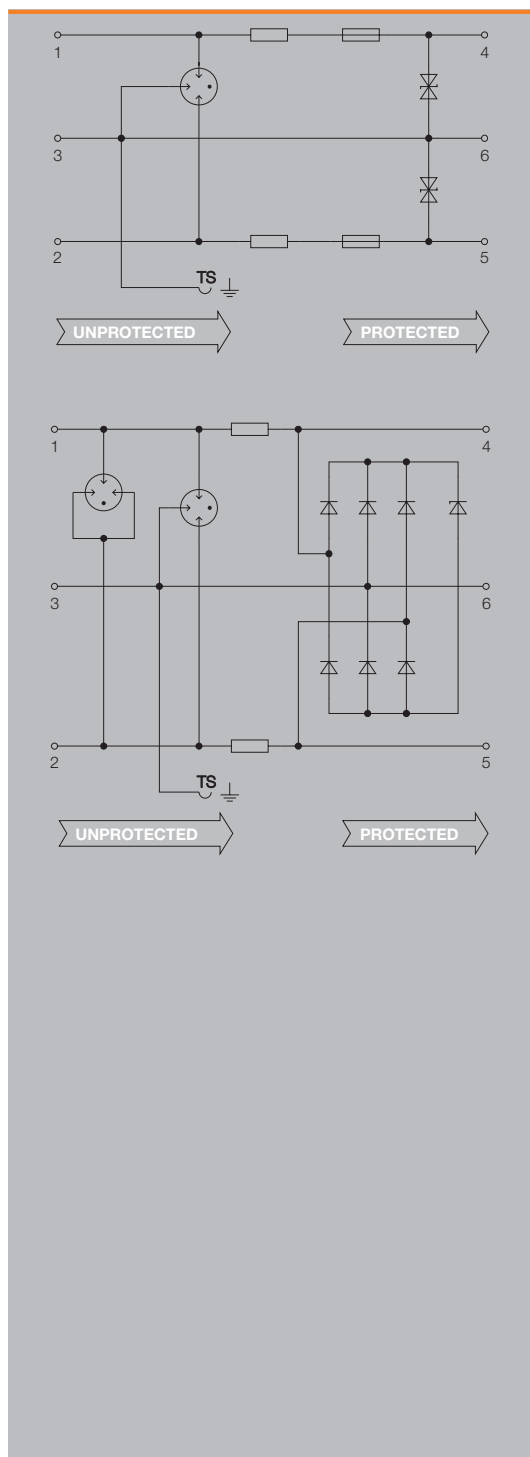

### Technical data

Rated current	500 mA
Dielectric strength at FG against PE	
Volume resistance	1.8 Ω 10 %
Overload - failure mode	Modus 2
Requirements category acc. to IEC 61643-21	C2, C3, D1
Standards	IEC 61643-21
Surge current-carrying capacity C1	
Surge current-carrying capacity C2	2.5 kA 8/20 μs 5 kV 1.2/50 μs
Surge current-carrying capacity C3	10 A 10/1000 μs
Surge current-carrying capacity D1	0.5 kA 10/350 μs
Discharge current I <sub>d</sub> (8/20 μs) wire-wire/wire-PE/GND-PE	2.5 kA / 2.5 kA /
Discharge I <sub>max</sub> (8/20 μs) wire-wire/wire-PE/GND-PE	10 kA / 10 kA /
Lightning test I <sub>imp</sub> (10/350 μs) wire-wire/wire-PE/GND-PE	/ 0.5 kA /
Storage temperature	-40 °C...+80 °C
Ambient temperature (operational)	-40 °C...+70 °C
Protection degree	IP 20
UL 94 flammability rating	V-0
<b>Connection data</b>	
Type of connection	Screw connection, Torx® T15, Slotted 0.8 x 4
Tightening torque	0.5 Nm
Wire connection cross section, finely stranded, max.	4 mm <sup>2</sup>
Wire connection cross-section, finely stranded, min.	0.5 mm <sup>2</sup>
Wire cross-section, solid, max.	6 mm <sup>2</sup>
Wire cross-section, solid, min.	0.5 mm <sup>2</sup>
Wire cross-section, stranded, max.	4 mm <sup>2</sup>
Wire cross-section, stranded, min.	0.5 mm <sup>2</sup>
Stripping length	10 mm
Mounting rail	TS 35
<b>Failure probability</b>	
λges	60
MTTF	1903
SIL in compliance with IEC 61508	3
<b>Approvals</b>	
Approvals	CE; GOSTME25; OEVE; TUEV; UL; ROHS
Standards	IEC 61643-21

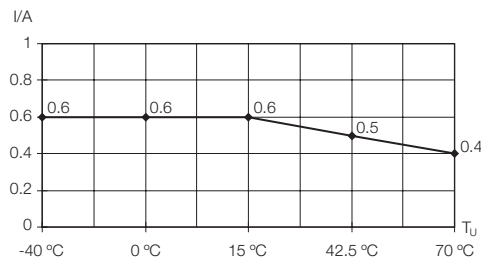

### Dimensions

Height x width x depth mm 88.5 / 6.1 / 81

### Note

## VSSC 6 RS485, RS485 DP and RS232

## Ordering data

	RS485	RS485 DP	RS232
Rated voltage (AC)			
Rated voltage (DC)	12 V	12 V	12 V
Max. continuous voltage, U <sub>c</sub> (AC)			
Max. continuous voltage, U <sub>c</sub> (DC)	15 V	15 V	15 V
Rated current	500 mA	500 mA	500 mA
Optical function display	No	No	No
Isolating function	No	No	No
Input attenuation	113.6 MHz	113.6 MHz	1.4 MHz
Pulse-reset capacity	≤ 15 ms	≤ 15 ms	≤ 15 ms
Residual voltage, U <sub>r</sub> , typical	94 V	94 V	80 V

## Ordering data

	RS485	RS485 DP	RS232
Type	VSSC6 RS485	VSSC6 RS485 DP	VSSC6 RS232
Order No.	<b>1064980000</b>	<b>1065010000</b>	<b>1064990000</b>
Qty.	10 ST	10 ST	10 ST
Note	End plate AP VSSC6 1063110000	End plate AP VSSC6 1063110000	End plate AP VSSC6 1063110000



## VARITECTOR SSC 6AN

### VSSC 6 RTD - protection for PT100 signal interfaces

- One-stage surge protection with screw connection for measurement and control signals
- Surge protection in terminal block design
- Modular width of only 6.2 mm
- Space-saving design for two signals
- Torx® slotted screw connection
- Can be used in compliance with installation standard IEC 62305
- Tested in accordance with IEC 61643-21: C1, C2
- Integrated PE foot, safely discharges up to 20 kA (8/20 μs) and 2.5 kA (10/350 μs) to PE



Similar to illustration



Similar to illustration

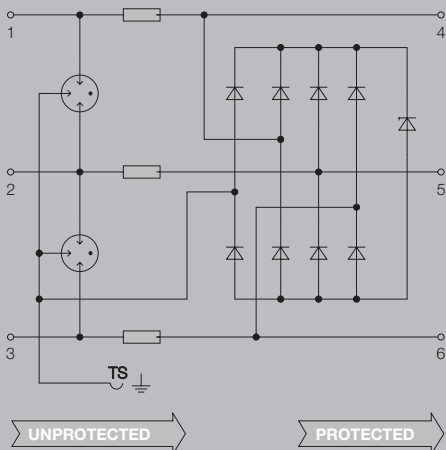

### Technical data

Rated current	300 mA
Dielectric strength at FG against PE	
Volume resistance	1.8 Ω 10 %
Overload - failure mode	Modus 2
Requirements category acc. to IEC 61643-21	C2, C3, D1
Standards	IEC 61643-21
Surge current-carrying capacity C1	
Surge current-carrying capacity C2	2.5 kA 8/20 μs 5 kV 1.2/50 μs
Surge current-carrying capacity C3	10 A 10/1000 μs
Surge current-carrying capacity D1	0.5 kA 10/350 μs
Discharge current I <sub>d</sub> (8/20 μs) wire-wire/wire-PE/GND-PE	2.5 kA / 2.5 kA /
Discharge I <sub>max</sub> (8/20 μs) wire-wire/wire-PE/GND-PE	5 kA / 5 kA /
Lightning test I <sub>imp</sub> (10/350 μs) wire-wire/wire-PE/GND-PE	
Storage temperature	-40 °C...+80 °C
Ambient temperature (operational)	-40 °C...+70 °C
Protection degree	IP 20
UL 94 flammability rating	V-0
<b>Connection data</b>	
Type of connection	Screw connection, Torx® T15, Slotted 0.8 x 4
Tightening torque	Nm
Wire connection cross section, finely stranded, max.	4 mm <sup>2</sup>
Wire connection cross-section, finely stranded, min.	0.5 mm <sup>2</sup>
Wire cross-section, solid, max.	6 mm <sup>2</sup>
Wire cross-section, solid, min.	0.5 mm <sup>2</sup>
Wire cross-section, stranded, max.	4 mm <sup>2</sup>
Wire cross-section, stranded, min.	0.5 mm <sup>2</sup>
Stripping length	10 mm
Mounting rail	TS 35
<b>Failure probability</b>	
λges	63
MTTF	1812
SIL in compliance with IEC 61508	3
<b>Approvals</b>	
Approvals	CE; GOSTME25; OEVE; TUEV; UL; ROHS
Standards	IEC 61643-21

### Dimensions

Height x width x depth mm 88.5 / 6.1 / 81

### Note

VSSC 6 RTD

Ordering data

Rated voltage (AC)  
 Rated voltage (DC)  
 Max. continuous voltage, U<sub>c</sub> (AC)  
 Max. continuous voltage, U<sub>c</sub> (DC)  
 Rated current  
 Optical function display  
 Isolating function  
 Input attenuation  
 Residual voltage, U<sub>r</sub> typical

RTD	
	1 V
	5 V
	300 mA
	No
	113.6 MHz
	126 V

Ordering data

Type  
 Order No.  
 Qty.

VSSC6 RTD
<b>1139710000</b>
10 ST
End plate AP VSSC6 1063110000

Note

End plate AP VSSC6 1063110000



## VARITECTOR SSC

### Lightning and surge protection in terminal block design

**The new and comprehensive surge protection family for measurement and control technology in 6 mm overall width**

The interfaces in C&I applications must be protected against surges, since coupling of surges on lines can interfere with or destroy signal inputs. It is therefore necessary that C&I devices be protected in their immediate vicinity. For this purpose, VARITECTOR SSC, with its compact terminal-block format, is ideal for this application. The protective circuits are matched to the current loops and to binary signals.

The VARITECTOR SSC products are tested according to the latest standards (IEC61643-21): They satisfy the safe short-circuit mode in the event of overload by AC currents in classes D1, C2 and C1. The products are ATEX-tested for use in intrinsically safe circuits.

#### Easy to use

The clamping area of 0.5 mm<sup>2</sup> – 6 mm<sup>2</sup> is covered with combined Torx®/Slot headed screw and a tightening torque of 0.8 Nm.



#### Space-saving

Modular width of terminals just 6.2 mm for two binary signals or per analogue signal.



**Large variety**

A solution for every type of surge protection:  
More than 100 variations: current loops and  
binary signals for 5 V, 12 V, 24 V, 48 V and  
60 V, with integrated components, e.g. varistors.

**Quick identification**

Large-area marking options: marking of devices  
and single connections as well as colour-  
coded marking of the voltage levels for fast  
identification in the switching cabinet.

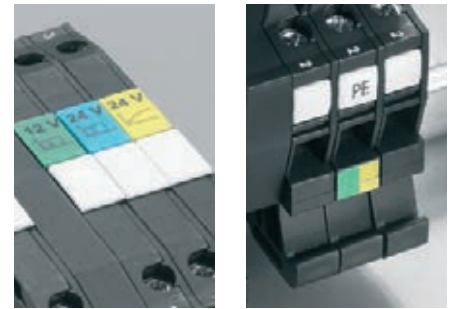
**Simple and safe**

Simple installation and high safety through  
direct PE contact when mounting on the  
terminal rail, with a very high discharge current  
of up to 20 kA.



## VARITECTOR SSC 4AN

### VSSC 4 CL and CL FG - protection for current loops

- Two-stage surge protection with screw connection for measurement and control signals
- Surge protection in terminal block design
- Modular width of only 6.2 mm
- Space-saving design: 1 analogue signal
- Torx® slotted screw connection
- Can be used in compliance with installation standard IEC 62305
- Integrated PE foot, safely discharges up to 20 kA (8/20 μs) and 2.5 kA (10/350 μs) to PE



**B**

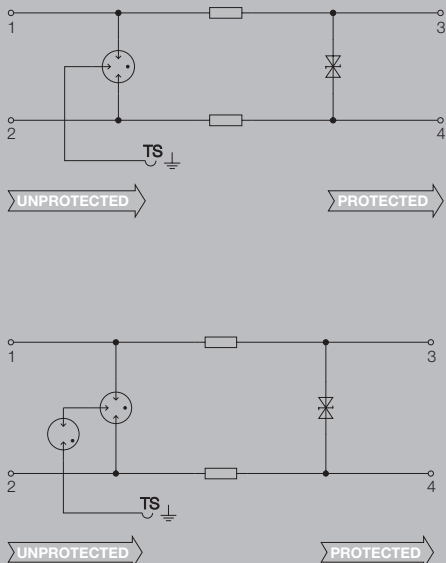

### Technical data

Rated current	500 mA
Dielectric strength at FG against PE	≥ 500 V
Volume resistance	1.8 Ω 10 %
Overload - failure mode	Modus 2
Requirements category acc. to IEC 61643-21	C2, C3, D1
Standards	IEC 61643-21
<b>Surge current-carrying capacity C1</b>	
Surge current-carrying capacity C2	2.5 kA 8/20 μs 5 kV 1.2/50 μs
Surge current-carrying capacity C3	50 A 10/1000 μs
Surge current-carrying capacity D1	0.5 kA 10/350 μs
Discharge current $I_t$ (8/20 μs) wire-wire/wire-PE/GND-PE	2.5 kA / 2.5 kA /
Discharge $I_{max}$ (8/20 μs) wire-wire/wire-PE/GND-PE	5 kA / 5 kA /
Lightning test $I_{imp}$ (10/350 μs) wire-wire/wire-PE/GND-PE	/ 0.5 kA /
Storage temperature	-40 °C...+80 °C
Ambient temperature (operational)	-40 °C...+70 °C
Protection degree	IP 20
UL 94 flammability rating	V-0
<b>Connection data</b>	
Type of connection	Screw connection, Torx® T15, Slotted 0.8 x 4
Tightening torque	0.5 Nm
Wire connection cross section, finely stranded, max.	4 mm <sup>2</sup>
Wire connection cross-section, finely stranded, min.	0.5 mm <sup>2</sup>
Wire cross-section, solid, max.	6 mm <sup>2</sup>
Wire cross-section, solid, min.	0.5 mm <sup>2</sup>
Wire cross-section, stranded, max.	4 mm <sup>2</sup>
Wire cross-section, stranded, min.	0.5 mm <sup>2</sup>
Stripping length	10 mm
Mounting rail	TS 35
<b>Failure probability</b>	
λges	19
MTTF	6008
SIL in compliance with IEC 61508	2
<b>Approvals</b>	
Approvals	CE; GOSTME25; OEVE; TUEV; UL; ROHS
Standards	IEC 61643-21

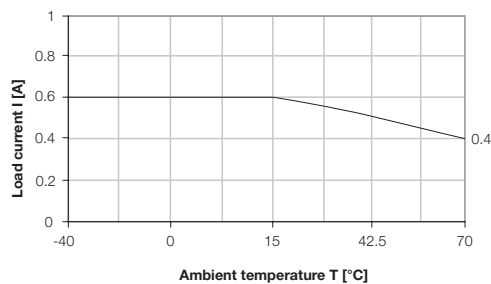

### Dimensions

Height x width x depth mm 76 / 6.1 / 58.5

### Note

VSSC 4 CL and CL FG

Ordering data

	VSSC4 CL 12 V DC 0.5 A	VSSC4 CL 24 V UC 0.5 A	VSSC4 CL 48 V UC 0.5 A	VSSC4 CL 60 V UC 0.5 A
Rated voltage (AC)		24 V	48 V	60 V
Rated voltage (DC)	12 V	34 V	68 V	85 V
Max. continuous voltage, U <sub>c</sub> (AC)		30 V	60 V	75 V
Max. continuous voltage, U <sub>c</sub> (DC)	15 V	42 V	85 V	106 V
Rated current	500 mA	500 mA	500 mA	500 mA
Optical function display	No	No	No	No
Isolating function	No	No	No	No
Input attenuation	750 KHz	3.4 MHz	5 Mhz	6.8 MHz
Pulse-reset capacity	≤ 20 ms	≤ 150 ms	≤ 110 ms	≤ 20 ms
Residual voltage, U <sub>r</sub> typical	912 V	918 V	773 V	770 V

Ordering data

	VSSC4 CL 12VDC 0.5A	VSSC4 CL 24VAC/DC 0.5A	VSSC4 CL 48VAC/DC 0.5A	VSSC4 CL 60VAC/DC 0.5A
Type	VSSC4 CL 12VDC 0.5A	VSSC4 CL 24VAC/DC 0.5A	VSSC4 CL 48VAC/DC 0.5A	VSSC4 CL 60VAC/DC 0.5A
Order No.	<b>1063720000</b>	<b>1063730000</b>	<b>1063740000</b>	<b>1063750000</b>
Qty.	10 ST	10 ST	10 ST	10 ST
Note	End plate AP VSSC4 1063120000	End plate AP VSSC4 1063120000	End plate AP VSSC4 1063120000	End plate AP VSSC4 1063120000

Ordering data

	VSSC4 CL FG 12 V DC 0.5 A	VSSC4 CL FG 24 V UC 0.5 A	VSSC4 CL FG 48 V UC 0.5 A	VSSC4 CL FG 60 V UC 0.5 A
Rated voltage (AC)		24 V	48 V	60 V
Rated voltage (DC)	12 V	34 V	68 V	85 V
Max. continuous voltage, U <sub>c</sub> (AC)		30 V	60 V	75 V
Max. continuous voltage, U <sub>c</sub> (DC)	15 V	42 V	85 V	106 V
Rated current	500 mA	500 mA	500 mA	500 mA
Optical function display	No	No	No	No
Isolating function	No	No	No	No
Input attenuation	750 KHz	3.4 MHz	5 Mhz	6.8 MHz
Pulse-reset capacity	≤ 20 ms	≤ 20 ms	≤ 20 ms	≤ 20 ms
Residual voltage, U <sub>r</sub> typical	1434 V	1407 V	1419 V	1398 V

Ordering data

	VSSC4 CL FG 12VDC 0.5A	VSSC4 CL FG24VAC/DC0.5A	VSSC4 CL FG48VAC/DC0.5A	VSSC4 CL FG60VAC/DC0.5A
Type	VSSC4 CL FG 12VDC 0.5A	VSSC4 CL FG24VAC/DC0.5A	VSSC4 CL FG48VAC/DC0.5A	VSSC4 CL FG60VAC/DC0.5A
Order No.	<b>1063760000</b>	<b>1063770000</b>	<b>1063780000</b>	<b>1063790000</b>
Qty.	10 ST	10 ST	10 ST	10 ST
Note	End plate AP VSSC4 1063120000	End plate AP VSSC4 1063120000	End plate AP VSSC4 1063120000	End plate AP VSSC4 1063120000



B

## VARITECTOR SSC 4AN

### VSSC 4 SL and SL FG - protection for binary signal

- Two-stage surge protection with screw connection for measurement and control signals
- Surge protection in terminal block design
- Modular width of only 6.2 mm
- Space-saving design: 1 binary signal
- Torx® slotted screw connection
- Can be used in compliance with installation standard IEC 62305
- Tested in accordance with IEC 61643-21:08 D1, C1, C2, C3
- Integrated PE foot, safely discharges up to 20 kA (8/20 μs) and 2.5 kA (10/350 μs) to PE



**B**

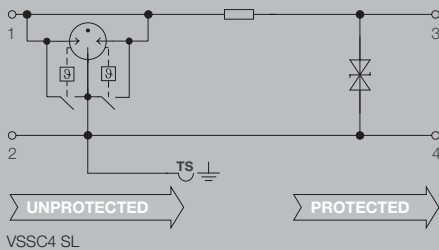

VSSC4 SL

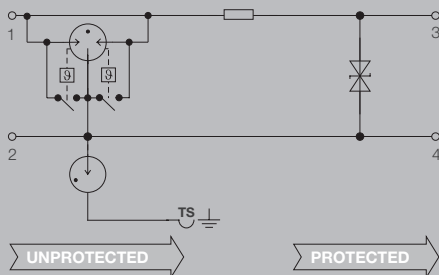

VSSC SL FG

### Technical data

Rated current	500 mA
Dielectric strength at FG against PE	≥ 500 V
Volume resistance	1.8 Ω 10 %
Overload - failure mode	Modus 2
Requirements category acc. to IEC 61643-21	C2, C3, D1
Standards	IEC 61643-21
Surge current-carrying capacity C1	
Surge current-carrying capacity C2	2.5 kA 8/20 μs 5 kV 1.2/50 μs
Surge current-carrying capacity C3	10 A 10/1000 μs
Surge current-carrying capacity D1	1 kA 10/350 μs
Discharge current $I_t$ (8/20 μs) wire-wire/wire-PE/GND-PE	/ 2.5 kA /
Discharge $I_{max}$ (8/20 μs) wire-wire/wire-PE/GND-PE	/ 10 kA /
Lightning test $I_{imp}$ (10/350 μs) wire-wire/wire-PE/GND-PE	/ 0.5 kA /
Storage temperature	-40 °C...+80 °C
Ambient temperature (operational)	-40 °C...+70 °C
Protection degree	IP 20
UL 94 flammability rating	V-0
<b>Connection data</b>	
Type of connection	Screw connection, Torx® T15, Slotted 0.8 x 4
Tightening torque	0.5 Nm
Wire connection cross section, finely stranded, max.	4 mm <sup>2</sup>
Wire connection cross-section, finely stranded, min.	0.5 mm <sup>2</sup>
Wire cross-section, solid, max.	6 mm <sup>2</sup>
Wire cross-section, solid, min.	0.5 mm <sup>2</sup>
Wire cross-section, stranded, max.	4 mm <sup>2</sup>
Wire cross-section, stranded, min.	0.5 mm <sup>2</sup>
Stripping length	10 mm
Mounting rail	TS 35
<b>Failure probability</b>	
λges	43
MTTF	2655
SIL in compliance with IEC 61508	3
<b>Approvals</b>	
Approvals	CE; GOSTME25; OEVE; TUEV; UL; ROHS
Standards	IEC 61643-21

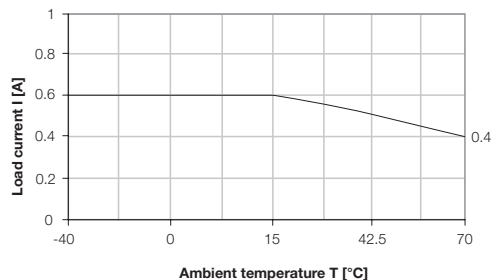

### Dimensions

Height x width x depth mm 76 / 6.2 / 58.5

### Note

## VSSC 4 SL and SL FG

## Ordering data

	VSSC4 SL 12 V DC 0.5 A	VSSC4 SL 24 V UC 0.5 A	VSSC4 SL 48 V UC 0.5 A	VSSC4 SL 60 V UC 0.5 A
Rated voltage (AC)		24 V	48 V	60 V
Rated voltage (DC)	12 V	34 V	68 V	85 V
Max. continuous voltage, U <sub>c</sub> (AC)		30 V	60 V	75 V
Max. continuous voltage, U <sub>c</sub> (DC)	15 V	42 V	85 V	106 V
Rated current	500 mA	500 mA	500 mA	500 mA
Optical function display	No	No	No	No
Isolating function	No	No	No	No
Input attenuation	860 KHz	3.4 MHz	5.2 MHz	6.6 MHz
Pulse-reset capacity	≤ 20 ms	≤ 35 ms	≤ 20 ms	≤ 20 ms
Residual voltage, U <sub>r</sub> typical	66 V	106 V	160 V	223 V

## Ordering data

	VSSC4 SL 12VDC 0.5A	VSSC4 SL 24VAC/DC 0.5A	VSSC4 SL 48VAC/DC 0.5A	VSSC4 SL 60VAC/DC 0.5A
Type	VSSC4 SL 12VDC 0.5A	VSSC4 SL 24VAC/DC 0.5A	VSSC4 SL 48VAC/DC 0.5A	VSSC4 SL 60VAC/DC 0.5A
Order No.	<b>1063830000</b>	<b>1063840000</b>	<b>1063860000</b>	<b>1063870000</b>
Qty.	10 ST	10 ST	10 ST	10 ST
Note	End plate AP VSSC4 1063120000	End plate AP VSSC4 1063120000	End plate AP VSSC4 1063120000	End plate AP VSSC4 1063120000

## Ordering data

	VSSC4 SL FG 12 V DC 0.5 A	VSSC4 SL FG 24 V UC 0.5 A	VSSC4 SL FG 48 V UC 0.5 A	VSSC4 SL FG 60 V UC 0.5 A
Rated voltage (AC)		24 V	48 V	60 V
Rated voltage (DC)	12 V	34 V	68 V	85 V
Max. continuous voltage, U <sub>c</sub> (AC)		30 V	60 V	75 V
Max. continuous voltage, U <sub>c</sub> (DC)	15 V	42 V	85 V	106 V
Rated current	500 mA	500 mA	500 mA	500 mA
Optical function display	No	No	No	No
Isolating function	No	No	No	No
Input attenuation	860 KHz	3.4 MHz	5.2 MHz	6.6 MHz
Pulse-reset capacity	≤ 20 ms	≤ 20 ms	≤ 35 ms	≤ 20 ms
Residual voltage, U <sub>r</sub> typical	66 V	106 V	160 V	223 V

## Ordering data

	VSSC4 SL FG 12VDC 0.5A	VSSC4 SL FG24VAC/DC0.5A	VSSC4 SL FG48VAC/DC0.5A	VSSC4 SL FG60VAC/DC0.5A
Type	VSSC4 SL FG 12VDC 0.5A	VSSC4 SL FG24VAC/DC0.5A	VSSC4 SL FG48VAC/DC0.5A	VSSC4 SL FG60VAC/DC0.5A
Order No.	<b>1063880000</b>	<b>1063890000</b>	<b>1063910000</b>	<b>1063920000</b>
Qty.	10 ST	10 ST	10 ST	10 ST
Note	End plate AP VSSC4 1063120000	End plate AP VSSC4 1063120000	End plate AP VSSC4 1063120000	End plate AP VSSC4 1063120000

B





**VARITECTOR SSC 4AN**

**VSSC 4 MOV - protection with Varistor (MOV)**

- One-stage surge protection with screw connection for measurement and control signals
- Surge protection in terminal block design
- Modular width of only 6.2 mm
- Space-saving design for one signal
- Torx® slotted screw connection
- Can be used in compliance with installation standard IEC 62305
- Tested in accordance with IEC 61643-21:08 : C1, C2, C3
- Integrated PE foot, safely discharges up to 20 kA (8/20 µs) and 2.5 kA (10/350 µs) to PE

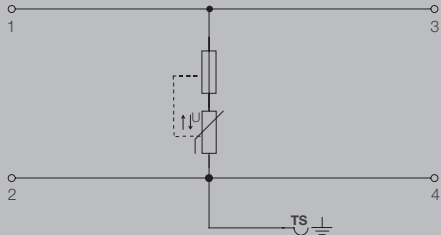

VSSC4 MOV

**Technical data**

Rated current	32 A
Dielectric strength at FG against PE	
Volume resistance	< 0.1 Ω
Overload - failure mode	Mode 1
Requirements category acc. to IEC 61643-21	C1
Standards	IEC 61643-21
Surge current-carrying capacity C1	0.25 kA 8/20 µs 0.5 kV 1.2/50 µs
Surge current-carrying capacity C2	1 kA 8/20 µs
Surge current-carrying capacity C3	
Surge current-carrying capacity D1	
Discharge current $I_t$ (8/20 µs) wire-wire/wire-PE/GND-PE	/ 0.5 kA /
Discharge $I_{max}$ (8/20 µs) wire-wire/wire-PE/GND-PE	/ 1 kA /
Lightning test $I_{imp}$ (10/350 µs) wire-wire/wire-PE/GND-PE	
Storage temperature	-40 °C...+80 °C
Ambient temperature (operational)	-40 °C...+70 °C
Protection degree	IP 20
UL 94 flammability rating	V-0
<b>Connection data</b>	
Type of connection	Screw connection, Torx® T15, Slotted 0.8 x 4
Tightening torque	0.5 Nm
Wire connection cross section, finely stranded, max.	4 mm <sup>2</sup>
Wire connection cross-section, finely stranded, min.	0.5 mm <sup>2</sup>
Wire cross-section, solid, max.	6 mm <sup>2</sup>
Wire cross-section, solid, min.	0.5 mm <sup>2</sup>
Wire cross-section, stranded, max.	4 mm <sup>2</sup>
Wire cross-section, stranded, min.	0.5 mm <sup>2</sup>
Stripping length	10 mm
Mounting rail	TS 35
<b>Failure probability</b>	
λges	26
MTTF	4391
SIL in compliance with IEC 61508	3
<b>Approvals</b>	
Approvals	CE; GOSTME25; OEVE; TUEV; UL; ROHS
Standards	IEC 61643-21

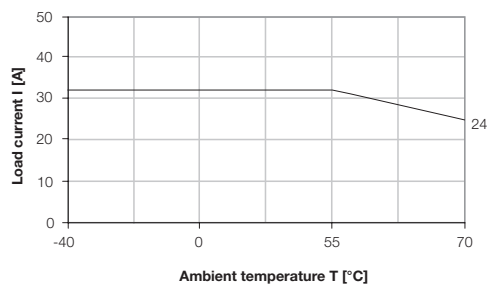

**Dimensions**

Height x width x depth mm 76 / 6.1 / 58.5

**Note**

VSSC MOV 4 - components

Ordering data

	VSSC4 MOV 12 V DC	VSSC4 MOV 24 V UC	VSSC4 MOV 48 V UC	VSSC4 MOV 60 V UC
Rated voltage (AC)		24 V	48 V	60 V
Rated voltage (DC)	12 V	34 V	68 V	85 V
Max. continuous voltage, U <sub>c</sub> (AC)		30 V	60 V	75 V
Max. continuous voltage, U <sub>c</sub> (DC)	15 V	42 V	85 V	106 V
Rated current	32 A	32 A	32 A	32 A
Optical function display	No	No	No	No
Isolating function	No	No	No	No
Requirements category acc. to IEC 61643-21	C1	C1	C1, C2	C1, C2
Pulse-reset capacity				
Residual voltage, U <sub>r</sub> typical	55 V	116 V	206 V	246 V
Capacitance	11.2 nF	4.8 nF	1.9 nF	1.7 nF

Ordering data	VSSC4 MOV 12VDC	VSSC4 MOV 24VAC/DC	VSSC4 MOV 48VAC/DC	VSSC4 MOV 60VAC/DC
Type	VSSC4 MOV 12VDC	VSSC4 MOV 24VAC/DC	VSSC4 MOV 48VAC/DC	VSSC4 MOV 60VAC/DC
Order No.	<b>1063950000</b>	<b>1063960000</b>	<b>1063970000</b>	<b>1063980000</b>
Qty.	10 ST	10 ST	10 ST	10 ST
Note	End plate AP VSSC4 1063120000	End plate AP VSSC4 1063120000	End plate AP VSSC4 1063120000	End plate AP VSSC4 1063120000

Ordering data

	VSSC4 MOV 120 V UC	VSSC4 MOV 150 V UC	VSSC4 MOV 240 V UC
Rated voltage (AC)	120 V	150 V	240 V
Rated voltage (DC)	170 V	212 V	339 V
Max. continuous voltage, U <sub>c</sub> (AC)	150 V	188 V	288 V
Max. continuous voltage, U <sub>c</sub> (DC)	212 V	266 V	407 V
Rated current	32 A	32 A	32 A
Optical function display	No	No	No
Isolating function	No	No	No
Requirements category acc. to IEC 61643-21	C1, C2	C1, C2	C1, C2
Pulse-reset capacity			
Residual voltage, U <sub>r</sub> typical	526 V	638 V	1022 V
Capacitance	1.48 nF	0.97 nF	0.7 nF

Ordering data	VSSC4 MOV 120VAC/DC	VSSC4 MOV 150VAC/DC	VSSC4 MOV 240VAC/DC
Type	VSSC4 MOV 120VAC/DC	VSSC4 MOV 150VAC/DC	VSSC4 MOV 240VAC/DC
Order No.	<b>1063990000</b>	<b>1064010000</b>	<b>1064020000</b>
Qty.	5 ST	5 ST	5 ST
Note	End plate AP VSSC4 1063120000	End plate AP VSSC4 1063120000	End plate AP VSSC4 1063120000



B

## VARITECTOR SSC 4AN

## VSSC 4 GDT - protection with sparkover gap (GDT)

- One-stage surge protection with screw connection for measurement and control signals
- Surge protection in terminal block design
- Modular width of only 12.4 mm
- Space-saving design for one signal
- Torx® slotted screw connection
- Can be used in compliance with installation standard IEC 62305
- Tested in accordance with IEC 61643-21:08 : C1, C2, C3
- Integrated PE foot, safely discharges up to 20 kA (8/20  $\mu$ s) and 2.5 kA (10/350  $\mu$ s) to PE

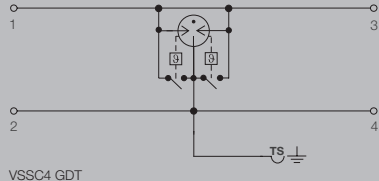
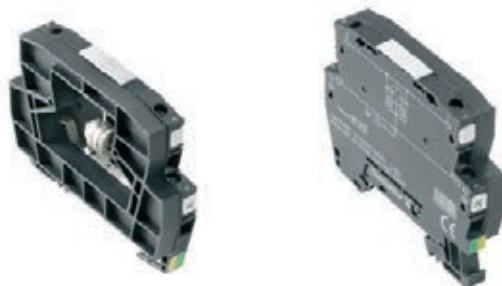

## Technical data

Rated current	32 A
Dielectric strength at FG against PE	
Volume resistance	< 0.1 $\Omega$
Overload - failure mode	Modus 2
Requirements category acc. to IEC 61643-21	C2, C3, D1
Standards	IEC 61643-21
Surge current-carrying capacity C1	
Surge current-carrying capacity C2	5 kA 8/20 $\mu$ s
Surge current-carrying capacity C3	100 A 10/1000 $\mu$ s
Surge current-carrying capacity D1	2.5 kA 10/350 $\mu$ s
Discharge current $I_t$ (8/20 $\mu$ s) wire-wire/wire-PE/GND-PE	/ 5 kA /
Discharge $I_{max}$ (8/20 $\mu$ s) wire-wire/wire-PE/GND-PE	/ 20 kA /
Lightning test $I_{imp}$ (10/350 $\mu$ s) wire-wire/wire-PE/GND-PE	/ 2.5 kA /
Storage temperature	-40 °C...+80 °C
Ambient temperature (operational)	-40 °C...+70 °C
Protection degree	IP 20
UL 94 flammability rating	V-0
<b>Connection data</b>	
Type of connection	Screw connection, Torx® T15, Slotted 0.8 x 4
Tightening torque	0.5 Nm
Wire connection cross section, finely stranded, max.	4 mm <sup>2</sup>
Wire connection cross-section, finely stranded, min.	0.5 mm <sup>2</sup>
Wire cross-section, solid, max.	6 mm <sup>2</sup>
Wire cross-section, solid, min.	0.5 mm <sup>2</sup>
Wire cross-section, stranded, max.	4 mm <sup>2</sup>
Wire cross-section, stranded, min.	0.5 mm <sup>2</sup>
Stripping length	10 mm
Mounting rail	TS 35
<b>Failure probability</b>	
$\lambda$ ges	10
MTTF	11416
SIL in compliance with IEC 61508	3
<b>Approvals</b>	
Approvals	CE; GOSTME25; TUEV; ROHS
Standards	IEC 61643-21

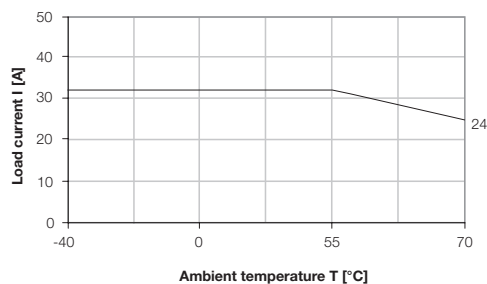

## Dimensions

Height x width x depth mm 76 / 12.2 / 58.5

## Note

VSSC 4 GDT - components

Ordering data

	VSSC4 GDT 110 V UC 20 kA	VSSC4 GDT 240 V UC 20 kA
Rated voltage (AC)	110 V	240 V
Rated voltage (DC)	156 V	339 V
Max. continuous voltage, U <sub>c</sub> (AC)	138 V	288 V
Max. continuous voltage, U <sub>c</sub> (DC)	195 V	407 V
Rated current	32 A	32 A
Optical function display	No	No
Isolating function	No	No
Residual voltage, U <sub>r</sub> typical	845 V	1144 V
Capacitance	4.65 pF	4.65 pF

Ordering data	VSSC4 GDT 110VAC/DC20kA	VSSC4 GDT 240VAC/DC20kA
Type	VSSC4 GDT 110VAC/DC20kA	VSSC4 GDT 240VAC/DC20kA
Order No.	<b>1064050000</b>	<b>1064060000</b>
Qty.	5 ST	5 ST
Note	End plate AP VSSC4 1063120000	End plate AP VSSC4 1063120000



## VARITECTOR SSC 4AN

## VSSC 4 TAZ - protection with suppressor diode (TAZ)

- One-stage surge protection with screw connection for measurement and control signals
- Surge protection in terminal block design
- Modular width of only 6.2 mm
- Space-saving design for one signal
- Torx® slotted screw connection
- Can be used in compliance with installation standard IEC 62305
- Tested in accordance with IEC 61643-21:08 : C1, C2, C3
- Integrated PE foot, safely discharges up to 20 kA (8/20 μs) and 2.5 kA (10/350 μs) to PE

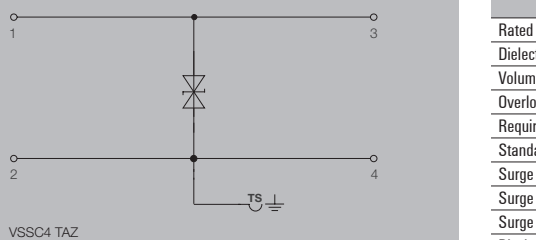

## Technical data

Rated current	32 A
Dielectric strength at FG against PE	
Volume resistance	< 0.1 Ω
Overload - failure mode	Mode 1
Requirements category acc. to IEC 61643-21	C3
Standards	IEC 61643-21
Surge current-carrying capacity C1	
Surge current-carrying capacity C2	
Surge current-carrying capacity D1	
Discharge current $I_1$ (8/20 μs) wire-wire/wire-PE/GND-PE	/ 0.2 kA /
Discharge $I_{max}$ (8/20 μs) wire-wire/wire-PE/GND-PE	/ 0.5 kA /
Lightning test $I_{imp}$ (10/350 μs) wire-wire/wire-PE/GND-PE	
Storage temperature	-40 °C...+80 °C
Ambient temperature (operational)	-40 °C...+70 °C
Protection degree	IP 20
UL 94 flammability rating	V-0
<b>Connection data</b>	
Type of connection	Screw connection, Torx® T15, Slotted 0.8 x 4
Tightening torque	0.5 Nm
Wire connection cross section, finely stranded, max.	4 mm <sup>2</sup>
Wire connection cross-section, finely stranded, min.	0.5 mm <sup>2</sup>
Wire cross-section, solid, max.	6 mm <sup>2</sup>
Wire cross-section, solid, min.	0.5 mm <sup>2</sup>
Wire cross-section, stranded, max.	4 mm <sup>2</sup>
Wire cross-section, stranded, min.	0.5 mm <sup>2</sup>
Stripping length	10 mm
Mounting rail	TS 35
<b>Failure probability</b>	
λges	32
MTTF	3567
SIL in compliance with IEC 61508	3
<b>Approvals</b>	
Approvals	CE; GOSTME25; OEVE; TUEV; UL; ROHS
Standards	IEC 61643-21

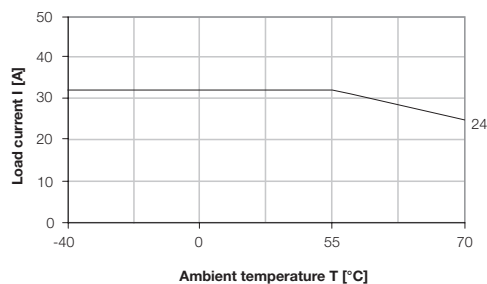

## Dimensions

Height x width x depth mm 76 / 6.1 / 58.5

## Note

VSSC 4 TAZ - components

Ordering data

	VSSC4 TAZ 12 V DC	VSSC4 TAZ 24 V UC	VSSC4 TAZ 48 V UC	VSSC4 TAZ 60 V UC
Rated voltage (AC)		24 V	48 V	60 V
Rated voltage (DC)	12 V	34 V	75 V	85 V
Max. continuous voltage, U <sub>c</sub> (AC)		30 V	60 V	75 V
Max. continuous voltage, U <sub>c</sub> (DC)	15 V	42 V	85 V	106 V
Rated current	32 A	32 A	32 A	32 A
Optical function display	No	No	No	No
Isolating function	No	No	No	No
Residual voltage, U <sub>r</sub> typical	22 V	61 V	80 V	100 V
Capacitance	5.06 nF	0.82 nF	0.45 nF	0.36 nF
Surge current-carrying capacity C3	50 A	15 A	15 A	15 A

Ordering data	VSSC4 TAZ 12VDC	VSSC4 TAZ 24VAC/DC	VSSC4 TAZ 48VAC/DC	VSSC4 TAZ 60VAC/DC
Type	VSSC4 TAZ 12VDC	VSSC4 TAZ 24VAC/DC	VSSC4 TAZ 48VAC/DC	VSSC4 TAZ 60VAC/DC
Order No.	<b>1064070000</b>	<b>1064080000</b>	<b>1064090000</b>	<b>1064110000</b>
Qty.	10 ST	10 ST	10 ST	10 ST
Note	End plate AP VSSC4 1063120000	End plate AP VSSC4 1063120000	End plate AP VSSC4 1063120000	End plate AP VSSC4 1063120000



## VARITECTOR SSC 4AN

## VSSC 4 RC - protection with a combination of resistors and capacitors

- Two-stage surge protection with screw connection for measurement and control signals
- Surge protection in terminal block design
- Modular width of only 12.4 mm
- Space-saving design for one signal
- Torx® slotted screw connection
- Can be used in compliance with installation standard IEC 62305
- Tested in accordance with IEC 61643-21:08
- Integrated PE foot, safely discharges up to 20 kA (8/20  $\mu$ s) and 2.5 kA (10/350  $\mu$ s) to PE

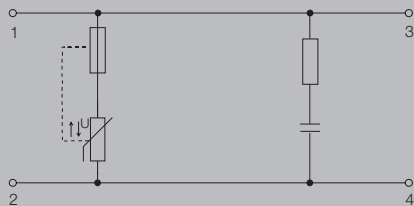
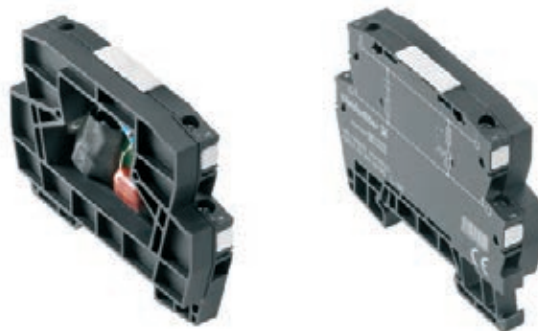

VSSC4 RC

## Technical data

Rated current	20 A
Dielectric strength at FG against PE	
Volume resistance	< 0.1 $\Omega$
Overload - failure mode	Mode 1
Requirements category acc. to IEC 61643-21	C1
Standards	IEC 61643-21
Surge current-carrying capacity C1	0.25 kA 8/20 $\mu$ s 0.5 kV 1.2/50 $\mu$ s
Surge current-carrying capacity C2	
Surge current-carrying capacity C3	
Surge current-carrying capacity D1	
Discharge current $I_d$ (8/20 $\mu$ s) wire-wire/wire-PE/GND-PE	/ 0.5 kA /
Discharge $I_{max}$ (8/20 $\mu$ s) wire-wire/wire-PE/GND-PE	
Lightning test $I_{imp}$ (10/350 $\mu$ s) wire-wire/wire-PE/GND-PE	
Storage temperature	-40 °C...+80 °C
Ambient temperature (operational)	-40 °C...+70 °C
Protection degree	IP 20
UL 94 flammability rating	V-0
<b>Connection data</b>	
Type of connection	Screw connection, Torx® T15, Slotted 0.8 x 4
Tightening torque	0.5 Nm
Wire connection cross section, finely stranded, max.	4 mm <sup>2</sup>
Wire connection cross-section, finely stranded, min.	0.5 mm <sup>2</sup>
Wire cross-section, solid, max.	6 mm <sup>2</sup>
Wire cross-section, solid, min.	0.5 mm <sup>2</sup>
Wire cross-section, stranded, max.	4 mm <sup>2</sup>
Wire cross-section, stranded, min.	0.5 mm <sup>2</sup>
Stripping length	10 mm
Mounting rail	TS 35
<b>Failure probability</b>	
$\lambda_{ges}$	28
MTTF	4048
SIL in compliance with IEC 61508	3
<b>Approvals</b>	
Approvals	CE; GOSTME25; OEVE; TUEV; UL; ROHS
Standards	IEC 61643-21

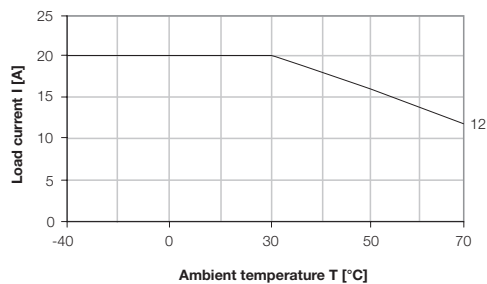

## Dimensions

Height x width x depth mm 76 / 12.2 / 58.5

## Note

VSSC 4 RC - components

Ordering data

	VSSC4 RC 24 V UC	VSSC4 RC 240 V UC
Rated voltage (AC)	24 V	240 V
Rated voltage (DC)	34 V	339 V
Max. continuous voltage, U <sub>c</sub> (AC)	30 V	275 V
Max. continuous voltage, U <sub>c</sub> (DC)	42 V	388 V
Rated current	20 A	20 A
Optical function display	No	No
Isolating function	No	No
Input attenuation		
Pulse-reset capacity		
Residual voltage, U <sub>r</sub> typical	119 V	500 V
Capacitance	8.5 nF	15.9 nF

Ordering data	VSSC4 RC 24VAC/DC	VSSC4 RC 240VAC/DC
Type	VSSC4 RC 24VAC/DC	VSSC4 RC 240VAC/DC
Order No.	<b>1064120000</b>	<b>1064130000</b>
Qty.	5 ST	5 ST
Note	End plate AP VSSC4 1063120000	End plate AP VSSC4 1063120000



# Narrow surge protection terminals with tension-clamp wire connections for measurement and control systems

Weidmüller MCZ surge protection terminals are characterised by their maximum protective function, and a compact design of only 6 mm. The tension spring connection and direct earthing via the terminal rail contact results in time-savings during installation.

The MCZ OVP terminals are suitable for installing in the tightest of places in automated process, industrial and building services systems.

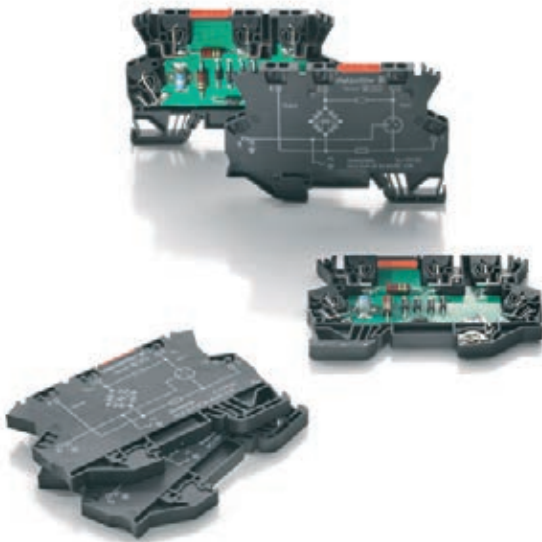

The three-stage surge protection terminals are fitted with gas discharge tubes, varistors, suppression diodes (TAZ) and decoupling inductors. Individual protective components such as varistors and suppression diodes complement the range. The MCZ OVP surge protection terminals are available with rated voltages of 24, 48, 115 and 230 V. The response time for the 3-stage MCZ OVP is typically 100 ps. The earth contact is produced by clipping the terminal to an earthed terminal rail. To guarantee a safe energy discharge of up to 10 kA (8/20  $\mu$ s) via these terminals, the TS 35 rail must be earthed.

EMC regulations require the terminal rail to be securely screwed to an earthed mounting plate. Optimum protection is achieved when the PE contact is made via a tension spring terminal every 600 mm.

## The different models

**MCZ OVP HF** is a two-stage protective combination with a bridge circuit consisting of suppressor diodes. With this circuitry, high transmission rates of up to 100 Mhz can be reached in 100 Ohm systems.

The protective circuitry is particularly suitable for protecting high-speed data transmission systems and high-speed analogue systems.

**MCZ OVP CL** is a three-stage protective combination with a suppression diode between the current paths. It limits the surge in analogue signal circuits, e.g. current loops.

**MCZ OVP SL** is a three-stage protective combination with two suppression diodes, each from the signal line to earth. It limits the surge in binary circuits, e.g. for actuators.

**MCZ OVP CL FG** is a three-stage protective combination with a suppression diode between the current paths. It limits the surge in analogue signal circuits. A high-resistance earth connection is achieved with a gas discharge tube.

**MCZ-OVP Filter-Terminals** contain selected varistors, capacitors and series inductances. They form reliable noise filters. Coupled interference in the kHz range is safely discharged to earth. For example, the signal inputs of a PLC, which can be protected against interference voltages and RF interference.

## Attenuation chart MCZ OVP Filter

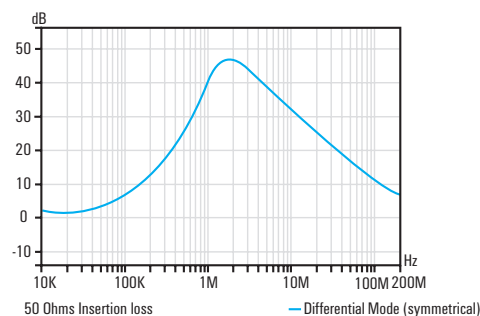



**MCZ OVP SL FG** is a three-stage protective combination with two suppression diodes, each from the signal line to earth. It limits the surge in binary circuits, e.g. for actuators. A high-resistance earth connection is achieved with three gas discharge tubes.

**Derating curve MCZ OVP**

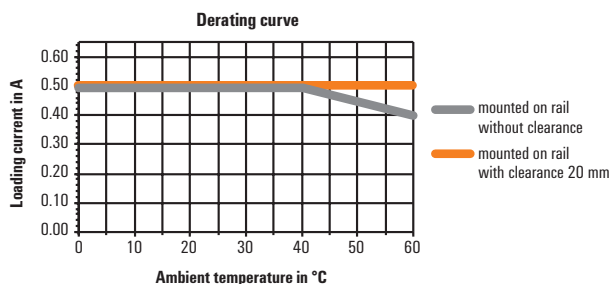

**Derating curve MCZ OVP**

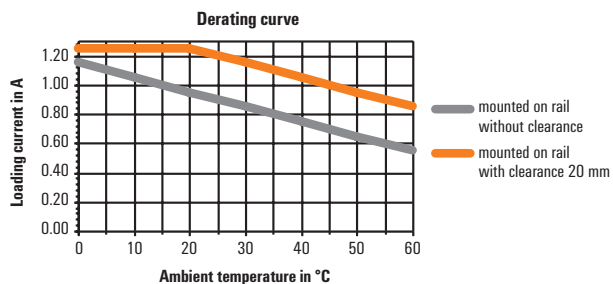

# MCZ OVP

## Lightning and surge protection for data interfaces

Weidmüller's "MCZ OVP" surge protection for industrial bus systems and data interfaces: Narrow surge-protection terminals with tension-clamp connections for PROFIBUS, Interbus, CAN, DeviceNet and LON™ – with no signal delay. The Omega stainless steel spring used for DIN rail contact ensures outstanding discharging characteristics that are consistent and reliable.

B

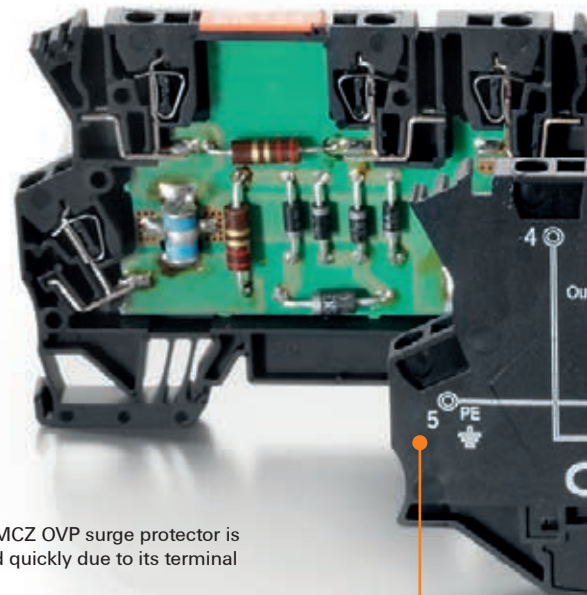

### Space-saving

The narrow 6-mm MCZ OVP surge protector is installed simply and quickly due to its terminal block design.

### Quick to connect

Maintenance-free tension-clamp wire connection: providing strong contact force and quick wiring times. This ensures a more securely clamped wire across the entire clamping area.

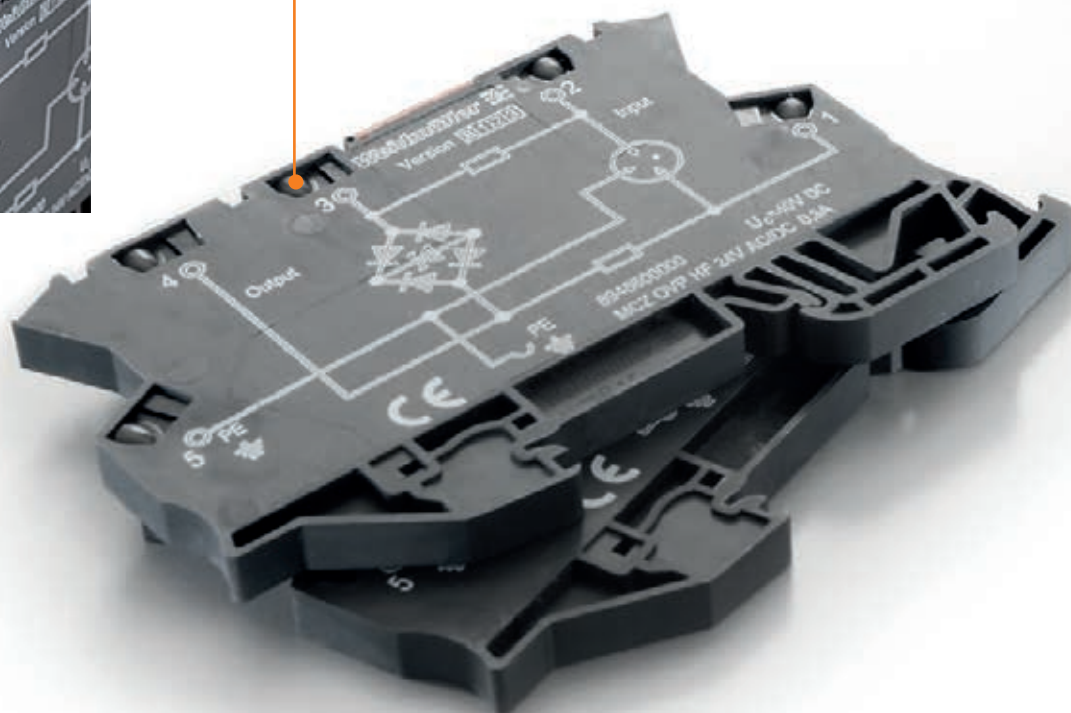

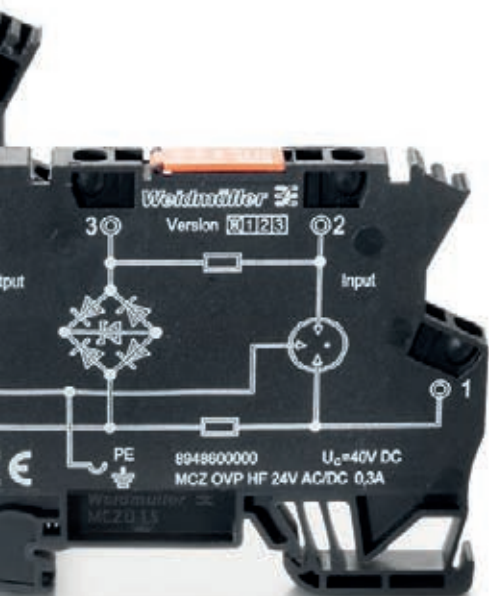

**Vibration-resistant PE contact**

Up to 10 kA (8/20  $\mu$ s) of surge voltage can be reliably discharged via the stainless steel Omega spring. This contact snaps onto the rail and requires no tools to install.

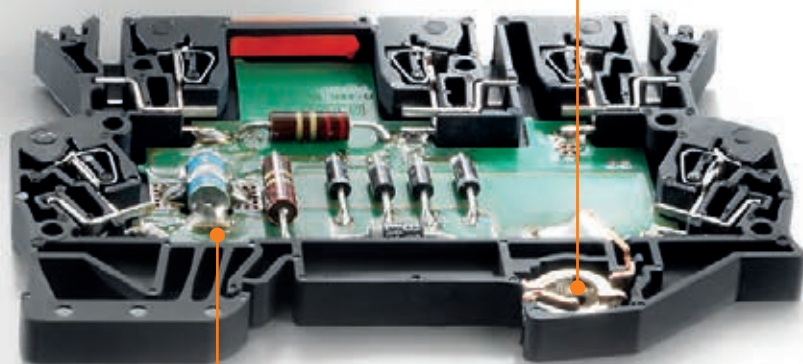
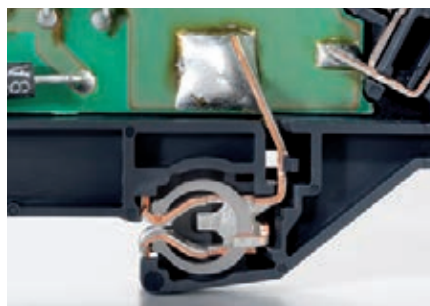

**High transfer rates with protection**

Variants are available for protecting data lines (including the following industrial bus systems: PROFIBUS, PROFINET, Interbus, C-Bus, MODBUS, LON™, CAN, DeviceNet, etc.)

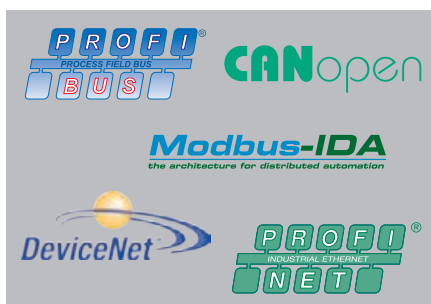

## MCZ OVP series

### 2-stage protection with tension clamp

#### connection

- Slim overvoltage protection terminal with tension clamp connection
- 6 mm slim fine overvoltage protection
- Fast wiring thanks to TS contact and tension clamp connections

### MCZ OVP HF 5 V 0.3 A

### MCZ OVP HF 12 V 0.3 A

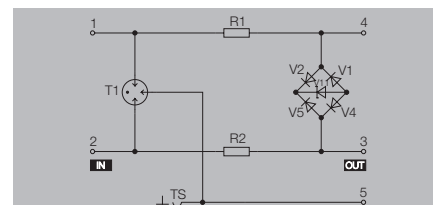
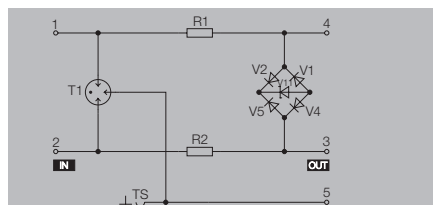

#### Technical data

Rated voltage (AC) / Rated voltage (DC)  
 Max. continuous voltage,  $U_c$  (AC)  
 Max. continuous voltage,  $U_c$  (DC)  
 Operating current,  $I_{max}$   
 Volume resistance  
 Gas discharge tube  
 Limiting frequency (-3 dB) at load resistance  
 Discharge current, max. (8/20  $\mu$ s)  
 Lightning test current  $I_{imp}$  (10/350  $\mu$ s)  
 Requirements category acc. to IEC 61643-21  
 Storage temperature  
 Ambient temperature (operational)

7 V / 5 V  
 7 V  
 10 V  
 0.3 A  
 2.50  $\Omega$   
 Yes  
 100 MHz (measured in 100- $\Omega$  system)  
 5 kA

13 V / 12 V  
 13 V  
 18.5 V  
 0.3 A  
 2.50  $\Omega$   
 Yes  
 100 MHz (measured in 100- $\Omega$  system)  
 5 kA

#### Protection level

Wire-PE 1 kV/ $\mu$ s, typically  
 Wire-PE 8/20  $\mu$ s, typically  
 Wire-wire 1 kV/ $\mu$ s, typically  
 Wire-wire 8/20  $\mu$ s, typically

D1, C3, C2, C1  
 -40 °C...+85 °C  
 -40 °C...+60 °C

C3, D1, C2, C1  
 -40 °C...+85 °C  
 -40 °C...+60 °C

#### Approvals

Approvals

CE; GOSTME25

CE; GOSTME25

#### Dimensions

Height x width x depth mm

91 / 6 / 63.5

91 / 6 / 63.5

#### Note

#### Ordering data

Type	Qty.	Order No.
MCZ OVP HF 5V 0,3A	10	8948620000

Type	Qty.	Order No.
MCZ OVP HF 12V 0,3A	10	8948610000

#### Note

#### Accessories

##### Note

End plate  
 AP MCZ 1,5 SW: 1046410000

End plate  
 AP MCZ 1,5 SW: 1046410000

## 2-stage protection with tension clamp

### connection

- Slim overvoltage protection terminal with tension clamp connection
- 6 mm slim fine overvoltage protection
- Fast wiring thanks to TS contact and tension clamp connections

## MCZ OVP HF 24 V 0.3 A

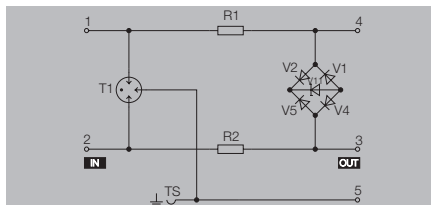

### Technical data

Rated voltage (AC) / Rated voltage (DC)  
 Max. continuous voltage, U<sub>c</sub> (AC)  
 Max. continuous voltage, U<sub>c</sub> (DC)  
 Operating current, I<sub>max</sub>  
 Volume resistance  
 Gas discharge tube  
 Limiting frequency (-3 dB) at load resistance  
 Discharge current, max. (8/20 μs)  
 Lightning test current I<sub>imp</sub> (10/350 μs)  
 Requirements category acc. to IEC 61643-21  
 Storage temperature  
 Ambient temperature (operational)

28 V / 24 V  
 28 V  
 40 V  
 0.3 A  
 2.50 Ω  
 Yes  
 100 MHz (measured in 100-Ω system)  
 5 kA  
 C3, D1, C2, C1  
 -40 °C...+85 °C  
 -40 °C...+60 °C

### Protection level

Wire-PE 1 kV/μs, typically  
 Wire-PE 8/20 μs, typically  
 Wire-wire 1 kV/μs, typically  
 Wire-wire 8/20 μs, typically

80 V  
 150 V  
 80 V  
 80 V

### Approvals

Approvals

CE; GOSTME25

### Dimensions

Height x width x depth mm

91 / 6 / 63.5

### Note

### Ordering data

Type	Qty.	Order No.
MCZ OVP HF 24V 0,3A	10	8948600000

### Note

### Accessories

#### Note

End plate  
 AP MCZ 1,5 SW: 1046410000

## MCZ OVP series

### 3- or 1-stage protection with tension clamp connection

- Slim overvoltage protection terminal with tension clamp connection
- 6 mm slim fine overvoltage protection
- Fast wiring thanks to TS contact and tension clamp connections

### MCZ OVP CL 24 V DC 0.5 A

Protection for current loops

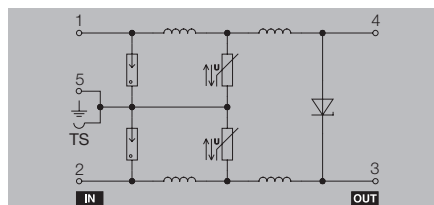

### MCZ OVP CL 24 V AC 0.5 A

Protection for current loops

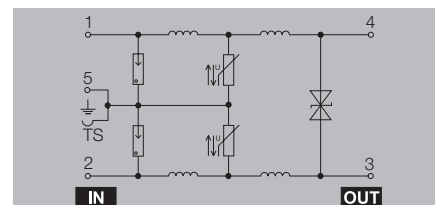

#### Technical data

Rated voltage (AC)	24 V
Rated voltage (DC)	28 V
Max. continuous voltage, U <sub>c</sub> (AC)	38 V
Operating current, I <sub>max</sub>	0.5 A
Volume resistance	2.50 Ω
Gas discharge tube	Yes
Varistor	Yes
Suppression diodes	Yes
Limiting frequency (-3 dB) at load resistance	500 kHz 240 Ω
Discharge current, max. (8/20 μs)	5 kA
Lightning test current I <sub>imp</sub> (10/350 μs)	1 kA
Requirements category acc. to IEC 61643-21	D1
Design	Terminal
Storage temperature	-40 °C...+85 °C
Ambient temperature (operational)	-40 °C...+60 °C

#### Protection level

Wire-PE 1kV/μs, typically	40 V
Wire-PE 8/20 μs, typically	65 V
Wire-wire 1 kV/μs, typically	40 V
Wire-wire 8/20 μs, typically	65 V

#### Approvals

Approvals

Rated voltage (AC)	24 V
Rated voltage (DC)	28 V
Max. continuous voltage, U <sub>c</sub> (AC)	38 V
Operating current, I <sub>max</sub>	0.5 A
Volume resistance	2.50 Ω
Gas discharge tube	Yes
Varistor	Yes
Suppression diodes	Yes
Limiting frequency (-3 dB) at load resistance	500 kHz 240 Ω
Discharge current, max. (8/20 μs)	5 kA
Lightning test current I <sub>imp</sub> (10/350 μs)	1 kA
Requirements category acc. to IEC 61643-21	D1
Design	Terminal
Storage temperature	-40 °C...+85 °C
Ambient temperature (operational)	-40 °C...+60 °C

Wire-PE 1kV/μs, typically	40 V
Wire-PE 8/20 μs, typically	65 V
Wire-wire 1 kV/μs, typically	40 V
Wire-wire 8/20 μs, typically	65 V

CE; GOSTME25; UL

Rated voltage (AC)	24 V
Rated voltage (DC)	28 V
Max. continuous voltage, U <sub>c</sub> (AC)	38 V
Operating current, I <sub>max</sub>	0.5 A
Volume resistance	1.00 Ω
Gas discharge tube	Yes
Varistor	Yes
Suppression diodes	Yes
Limiting frequency (-3 dB) at load resistance	500 kHz 240 Ω
Discharge current, max. (8/20 μs)	5 kA
Lightning test current I <sub>imp</sub> (10/350 μs)	1 kA
Requirements category acc. to IEC 61643-21	D1
Design	Terminal
Storage temperature	-40 °C...+85 °C
Ambient temperature (operational)	-40 °C...+60 °C

Wire-PE 1kV/μs, typically	45 V
Wire-PE 8/20 μs, typically	70 V
Wire-wire 1 kV/μs, typically	45 V
Wire-wire 8/20 μs, typically	70 V

CE; GOSTME25; UL

#### Dimensions

Height x width x depth mm

91 / 6 / 63.5

91 / 6 / 63.5

#### Note

See derating curve in the introduction to this catalogue

See derating curve in the introduction to this catalogue

#### Ordering data

Type	Qty.	Order No.
MCZ OVP CL 24VDC 0,5A	10	8448920000

Type	Qty.	Order No.
MCZ OVP CL 24VAC 0,5A	10	8472880000

#### Note

#### Accessories

##### Note

End plate  
AP MCZ 1,5 SW: 1046410000

End plate  
AP MCZ 1,5 SW: 1046410000

### 3- or 1-stage protection with tension clamp connection

- Slim overvoltage protection terminal with tension clamp connection
- 6 mm slim fine overvoltage protection
- Fast wiring thanks to TS contact and tension clamp connections

### MCZ OVP CL 24 V UC 1.25 A

Protection for current loops

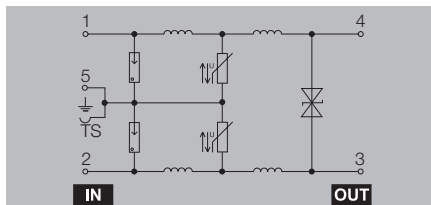

### MCZ OVP SL 24 V DC 0.5 A

Protection for binary signals

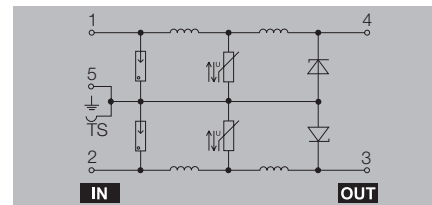

#### Technical data

Rated voltage (AC)
Rated voltage (DC)
Max. continuous voltage, U <sub>c</sub> (AC)
Operating current, I <sub>max</sub>
Volume resistance
Gas discharge tube
Varistor
Suppression diodes
Limiting frequency (-3 dB) at load resistance
Discharge current, max. (8/20 μs)
Lightning test current I <sub>imp</sub> (10/350 μs)
Requirements category acc. to IEC 61643-21
Design
Storage temperature
Ambient temperature (operational)

24 V
24 V
27 V
1.25 A
1.00 Ω
Yes
Yes
Yes
500 kHz 240 Ω
5 kA
1 kA
D1
Terminal
-40 °C...+85 °C
-40 °C...+60 °C

24 V
28 V
0.5 A
2.50 Ω
Yes
Yes
Yes
500 kHz 240 Ω
5 kA
1 kA
D1
Terminal
-40 °C...+85 °C
-40 °C...+60 °C

#### Protection level

Wire-PE 1kV/μs, typically
Wire-PE 8/20 μs, typically
Wire-wire 1 kV/μs, typically
Wire-wire 8/20 μs, typically

40 V
65 V
80 V
130 V

40 V
65 V
80 V
130 V

#### Approvals

Approvals

CE; GOSTME25; UL

CE; GOSTME25; UL

#### Dimensions

Height x width x depth mm

91 / 6 / 63.5

91 / 6 / 63.5

#### Note

See derating curve in the introduction to this catalogue

See derating curve in the introduction to this catalogue

#### Ordering data

Type	Qty.	Order No.
MCZ OVP CL 24VUC 1,25A	10	8448960000

Type	Qty.	Order No.
MCZ OVP SL 24VDC 0,5A	10	8448940000

#### Note

#### Accessories

##### Note

End plate  
AP MCZ 1,5 SW: 1046410000

End plate  
AP MCZ 1,5 SW: 1046410000



## MCZ OVP series

### 3- or 1-stage protection with tension clamp connection

- Slim overvoltage protection terminal with tension clamp connection
- 6 mm slim fine overvoltage protection
- Fast wiring thanks to TS contact and tension clamp connections

### MCZ OVP SL 24 V UC 1.25 A

Protection for binary signals

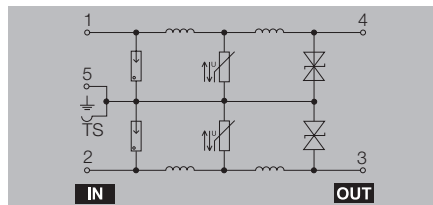

### MCZ OVP CL 48 V UC 0.5 A

Protection for current loops

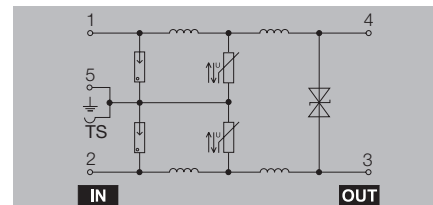

#### Technical data

Rated voltage (AC)  
 Rated voltage (DC)  
 Max. continuous voltage,  $U_c$  (AC)  
 Operating current,  $I_{max}$   
 Volume resistance  
 Gas discharge tube  
 Varistor  
 Suppression diodes  
 Limiting frequency (-3 dB) at load resistance  
 Discharge current, max. (8/20  $\mu$ s)  
 Lightning test current  $I_{imp}$  (10/350  $\mu$ s)  
 Requirements category acc. to IEC 61643-21  
 Design  
 Storage temperature  
 Ambient temperature (operational)

#### Protection level

Wire-PE 1kV/ $\mu$ s, typically  
 Wire-PE 8/20  $\mu$ s, typically  
 Wire-wire 1 kV/ $\mu$ s, typically  
 Wire-wire 8/20  $\mu$ s, typically

#### Approvals

Approvals

24 V  
 24 V  
 28 V  
 1.25 A  
 1.00  $\Omega$   
 Yes  
 Yes  
 Yes  
 500 kHz 240  $\Omega$   
 5 kA  
 1 kA  
 D1  
 Terminal  
 -40 °C...+85 °C  
 -40 °C...+60 °C

40 V  
 65 V  
 80 V  
 130 V

CE; GOSTME25; UL

48 V  
 48 V  
 53 V  
 0.5 A  
 2.50  $\Omega$   
 Yes  
 Yes  
 Yes  
 500 kHz 240  $\Omega$   
 5 kA  
 2.5 kA  
 D1  
 Terminal  
 -40 °C...+85 °C  
 -40 °C...+60 °C

80 V  
 150 V  
 82 V  
 150 V

CE; GOSTME25; UL

#### Dimensions

Height x width x depth mm

91 / 6 / 63.5

91 / 6 / 63.5

#### Note

See derating curve in the introduction to this catalogue

See derating curve in the introduction to this catalogue

#### Ordering data

Type	Qty.	Order No.
MCZ OVP SL 24VUC 1,25A	10	8448970000

Type	Qty.	Order No.
MCZ OVP CL 48VUC 0,5A	10	8449000000

#### Note

#### Accessories

#### Note

End plate  
 AP MCZ 1,5 SW: 1046410000

End plate  
 AP MCZ 1,5 SW: 1046410000

**3- or 1-stage protection with tension clamp connection**

- Slim overvoltage protection terminal with tension clamp connection
- 6 mm slim fine overvoltage protection
- Fast wiring thanks to TS contact and tension clamp connections

**MCZ OVP SL 48 V UC 0.5 A**

Protection for binary signals

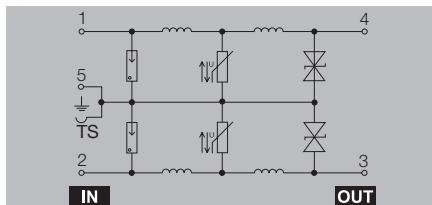

**MCZ OVP CL 48 V UC 1.25 A**

Protection for current loops

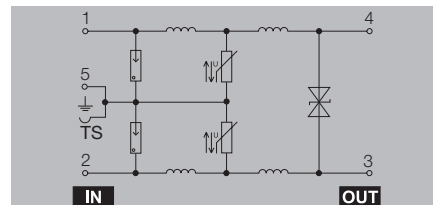

**Technical data**

Rated voltage (AC)
Rated voltage (DC)
Max. continuous voltage, U <sub>c</sub> (AC)
Operating current, I <sub>max</sub>
Volume resistance
Gas discharge tube
Varistor
Suppression diodes
Limiting frequency (-3 dB) at load resistance
Discharge current, max. (8/20 μs)
Lightning test current I <sub>imp</sub> (10/350 μs)
Requirements category acc. to IEC 61643-21
Design
Storage temperature
Ambient temperature (operational)

48 V
48 V
53 V
0.5 A
2.50 Ω
Yes
Yes
Yes
500 kHz 240 Ω
5 kA
1 kA
D1
Terminal
-40 °C...+85 °C
-40 °C...+60 °C

48 V
48 V
53 V
1.25 A
1.00 Ω
Yes
Yes
Yes
500 kHz 240 Ω
5 kA
1 kA
D1
Terminal
-40 °C...+85 °C
-40 °C...+60 °C

**Protection level**

Wire-PE 1kV/μs, typically
Wire-PE 8/20 μs, typically
Wire-wire 1 kV/μs, typically
Wire-wire 8/20 μs, typically

82 V
150 V
160 V
300 V

82 V
150 V
82 V
150 V

**Approvals**

Approvals

CE; GOSTME25; UL

CE; GOSTME25; UL

**Dimensions**

Height x width x depth mm

91 / 6 / 63.5

91 / 6 / 63.5

**Note**

See derating curve in the introduction to this catalogue

See derating curve in the introduction to this catalogue

**Ordering data**

Type	Qty.	Order No.
MCZ OVP SL 48VUC 0,5A	10	8449030000

Type	Qty.	Order No.
MCZ OVP CL 48VUC 1,25A	10	8449040000

**Note**

**Accessories**

**Note**

End plate  
AP MCZ 1,5 SW: 1046410000

End plate  
AP MCZ 1,5 SW: 1046410000



## MCZ OVP series

### 3- or 1-stage protection with tension clamp connection

- Slim overvoltage protection terminal with tension clamp connection
- 6 mm slim fine overvoltage protection
- Fast wiring thanks to TS contact and tension clamp connections

### MCZ OVP SL 48 V UC 1.25 A

Protection for binary signals

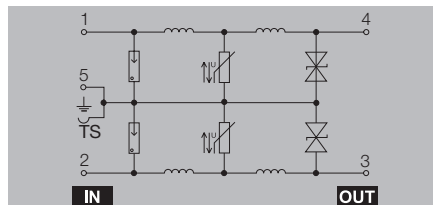

### MCZ OVP CL 115 V UC 1.25 A

Protection for current loops

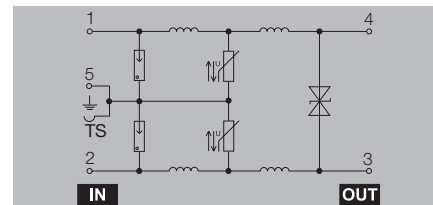

### Technical data

Rated voltage (AC)
Rated voltage (DC)
Max. continuous voltage, U <sub>c</sub> (AC)
Operating current, I <sub>max</sub>
Volume resistance
Gas discharge tube
Varistor
Suppression diodes
Limiting frequency (-3 dB) at load resistance
Discharge current, max. (8/20 μs)
Lightning test current I <sub>imp</sub> (10/350 μs)
Requirements category acc. to IEC 61643-21
Design
Storage temperature
Ambient temperature (operational)

#### Protection level

Wire-PE 1kV/μs, typically
Wire-PE 8/20 μs, typically
Wire-wire 1 kV/μs, typically
Wire-wire 8/20 μs, typically

#### Approvals

Approvals

48 V
48 V
53 V
1.25 A
1.00 Ω
Yes
Yes
Yes
500 kHz 240 Ω
5 kA
2.5 kA
D1
Terminal
-40 °C...+85 °C
-40 °C...+60 °C

80 V
150 V
160 V
300 V

CE; GOSTME25; UL

115 V
115 V
127 V
1.25 A
1.00 Ω
Yes
Yes
Yes
500 kHz 240 Ω
5 kA
1 kA
D1
Terminal
-40 °C...+85 °C
-40 °C...+60 °C

220 V
360 V
220 V
360 V

CE; GOSTME25

### Dimensions

Height x width x depth mm

91 / 6 / 63.5

91 / 6 / 63.5

### Note

See derating curve in the introduction to this catalogue

See derating curve in the introduction to this catalogue

### Ordering data

Type	Qty.	Order No.
MCZ OVP SL 48VUC 1,25A	10	8449050000

Type	Qty.	Order No.
MCZ OVP CL 115VUC 1,25A	10	8449060000

### Note

### Accessories

#### Note

End plate  
AP MCZ 1,5 SW: 1046410000

End plate  
AP MCZ 1,5 SW: 1046410000

### 3- or 1-stage protection with tension clamp connection

- Slim overvoltage protection terminal with tension clamp connection
- 6 mm slim fine overvoltage protection
- Fast wiring thanks to TS contact and tension clamp connections

### MCZ OVP SL 115 V UC 1.25 A

Protection for binary signals

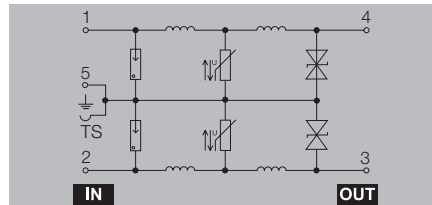

### MCZ OVP CL 230 V UC 1.25 A

Protection for current loops

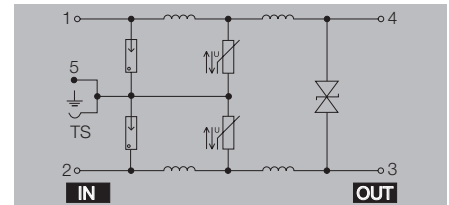

#### Technical data

Rated voltage (AC)	115 V
Rated voltage (DC)	115 V
Max. continuous voltage, U <sub>c</sub> (AC)	127 V
Operating current, I <sub>max</sub>	1.25 A
Volume resistance	1.00 Ω
Gas discharge tube	Yes
Varistor	Yes
Suppression diodes	Yes
Limiting frequency (-3 dB) at load resistance	500 kHz 240 Ω
Discharge current, max. (8/20 μs)	5 kA
Lightning test current I <sub>imp</sub> (10/350 μs)	2.5 kA
Requirements category acc. to IEC 61643-21	D1
Design	Terminal
Storage temperature	-40 °C...+85 °C
Ambient temperature (operational)	-40 °C...+60 °C

#### Protection level

Wire-PE 1kV/μs, typically	220 V
Wire-PE 8/20 μs, typically	360 V
Wire-wire 1 kV/μs, typically	440 V
Wire-wire 8/20 μs, typically	720 V

#### Approvals

Approvals

CE; GOSTME25

Rated voltage (AC)	230 V
Rated voltage (DC)	230 V
Max. continuous voltage, U <sub>c</sub> (AC)	250 V
Operating current, I <sub>max</sub>	1.25 A
Volume resistance	1.00 Ω
Gas discharge tube	Yes
Varistor	Yes
Suppression diodes	Yes
Limiting frequency (-3 dB) at load resistance	500 kHz 240 Ω
Discharge current, max. (8/20 μs)	5 kA
Lightning test current I <sub>imp</sub> (10/350 μs)	0.5 kA
Requirements category acc. to IEC 61643-21	D1
Design	Terminal
Storage temperature	-40 °C...+85 °C
Ambient temperature (operational)	-40 °C...+60 °C

Wire-PE 1kV/μs, typically	420 V
Wire-PE 8/20 μs, typically	710 V
Wire-wire 1 kV/μs, typically	420 V
Wire-wire 8/20 μs, typically	710 V

CE; GOSTME25

#### Dimensions

Height x width x depth mm

91 / 6 / 63.5

91 / 6 / 63.5

#### Note

See derating curve in the introduction to this catalogue

See derating curve in the introduction to this catalogue

#### Ordering data

Type	Qty.	Order No.
MCZ OVP SL 115VUC 1,25A	10	8449070000

Type	Qty.	Order No.
MCZ OVP CL 230VUC 1,25A	10	8449080000

#### Note

#### Accessories

##### Note

End plate  
AP MCZ 1,5 SW: 1046410000

End plate  
AP MCZ 1,5 SW: 1046410000



## MCZ OVP series

### 3- or 1-stage protection with tension clamp connection

- Slim overvoltage protection terminal with tension clamp connection
- 6 mm slim fine overvoltage protection
- Fast wiring thanks to TS contact and tension clamp connections

#### MCZ SL FG 24 V AC 0.5 A

Floating earth

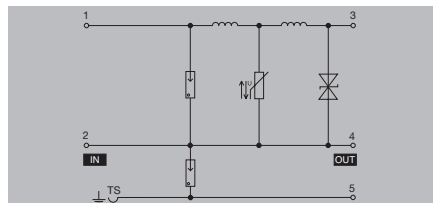

#### MCZ CL FG 24 V AC 0.5 A

Floating earth

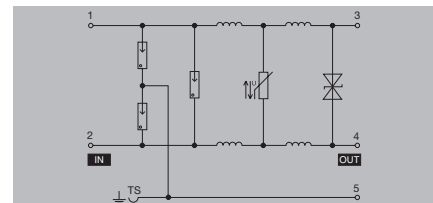

### Technical data

Rated voltage (AC)
Rated voltage (DC)
Max. continuous voltage, U <sub>c</sub> (AC)
Operating current, I <sub>max</sub>
Volume resistance
Gas discharge tube
Varistor
Suppression diodes
Limiting frequency (-3 dB) at load resistance
Discharge current, max. (8/20 μs)
Lightning test current I <sub>imp</sub> (10/350 μs)
Requirements category acc. to IEC 61643-21
Design
Storage temperature
Ambient temperature (operational)

#### Protection level

Wire-PE 1kV/μs, typically
Wire-PE 8/20 μs, typically
Wire-wire 1 kV/μs, typically
Wire-wire 8/20 μs, typically

#### Approvals

Approvals

24 V
24 V
28 V
0.5 A
1.00 Ω
Yes
Yes
Yes
500 kHz 240 Ω
5 kA
1 kA
D1
Terminal
-40 °C...+85 °C
-40 °C...+60 °C

40 V
65 V
40 V
65 V

CE; GOSTME25

24 V
24 V
28 V
0.5 A
2.50 Ω
Yes
Yes
Yes
500 kHz 240 Ω
5 kA
1 kA
D1
Terminal
-40 °C...+85 °C
-40 °C...+60 °C

40 V
65 V
40 V
65 V

CE; GOSTME25

### Dimensions

Height x width x depth mm

91 / 6 / 63.5

91 / 6 / 63.5

### Note

See derating curve in the introduction to this catalogue

See derating curve in the introductory text chapter

### Ordering data

Type	Qty.	Order No.
MCZ OVP SL FG 24VUC 0,5A	10	8823280000

Type	Qty.	Order No.
MCZ OVP CL FG 24VUC 0,5A	10	8704240000

### Note

### Accessories

#### Note

End plate  
AP MCZ 1,5 SW: 1046410000

End plate  
AP MCZ 1,5 SW: 1046410000

### 3- or 1-stage protection with tension clamp connection

- Slim overvoltage protection terminal with tension clamp connection
- 6 mm slim fine overvoltage protection
- Fast wiring thanks to TS contact and tension clamp connections

### MCZ OVP SL 230 V UC 1.25 A

Protection for binary signals

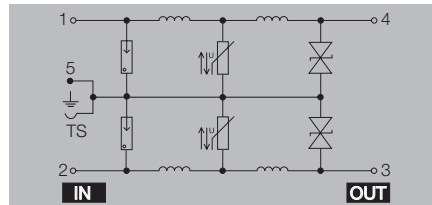

### MCZ OVP 24 V 0.5 A

Filter

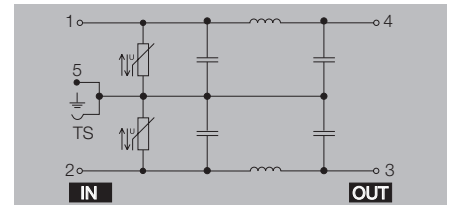

#### Technical data

Rated voltage (AC)	230 V
Rated voltage (DC)	230 V
Max. continuous voltage, U <sub>c</sub> (AC)	250 V
Operating current, I <sub>max</sub>	1.25 A
Volume resistance	1.00 Ω
Gas discharge tube	Yes
Varistor	Yes
Suppression diodes	Yes
Limiting frequency (-3 dB) at load resistance	500 kHz 240 Ω
Discharge current, max. (8/20 μs)	5 kA
Lightning test current I <sub>imp</sub> (10/350 μs)	< 0.5 kA
Requirements category acc. to IEC 61643-21	D1
Design	Terminal
Storage temperature	-40 °C...+85 °C
Ambient temperature (operational)	-40 °C...+60 °C
<b>Protection level</b>	
Wire-PE 1kV/μs, typically	420 V
Wire-PE 8/20 μs, typically	710 V
Wire-wire 1 kV/μs, typically	840 V
Wire-wire 8/20 μs, typically	1.420 V
<b>Approvals</b>	
Approvals	CE; GOSTME25

Rated voltage (AC)	24 V
Rated voltage (DC)	24 V
Max. continuous voltage, U <sub>c</sub> (AC)	26.4 V
Operating current, I <sub>max</sub>	0.5 A
Volume resistance	1.50 Ω
Gas discharge tube	No
Varistor	Yes
Suppression diodes	No
Limiting frequency (-3 dB) at load resistance	50 kHz 50 Ω
Discharge current, max. (8/20 μs)	0.5 kA
Lightning test current I <sub>imp</sub> (10/350 μs)	
Requirements category acc. to IEC 61643-21	
Design	Terminal
Storage temperature	-40 °C...+85 °C
Ambient temperature (operational)	-40 °C...+60 °C
<b>Protection level</b>	
Wire-PE 1kV/μs, typically	70 V
Wire-PE 8/20 μs, typically	100 V
Wire-wire 1 kV/μs, typically	140 V
Wire-wire 8/20 μs, typically	190 V
<b>Approvals</b>	
Approvals	CE; GOSTME25

Rated voltage (AC)	24 V
Rated voltage (DC)	24 V
Max. continuous voltage, U <sub>c</sub> (AC)	26.4 V
Operating current, I <sub>max</sub>	0.5 A
Volume resistance	1.50 Ω
Gas discharge tube	No
Varistor	Yes
Suppression diodes	No
Limiting frequency (-3 dB) at load resistance	50 kHz 50 Ω
Discharge current, max. (8/20 μs)	0.5 kA
Lightning test current I <sub>imp</sub> (10/350 μs)	
Requirements category acc. to IEC 61643-21	
Design	Terminal
Storage temperature	-40 °C...+85 °C
Ambient temperature (operational)	-40 °C...+60 °C
<b>Protection level</b>	
Wire-PE 1kV/μs, typically	70 V
Wire-PE 8/20 μs, typically	100 V
Wire-wire 1 kV/μs, typically	140 V
Wire-wire 8/20 μs, typically	190 V
<b>Approvals</b>	
Approvals	CE; GOSTME25

#### Dimensions

Height x width x depth mm

91 / 6 / 63.5

91 / 6 / 63.5

#### Note

See derating curve in the introduction to this catalogue

See derating curve in the introduction to this catalogue

#### Ordering data

Type	Qty.	Order No.
MCZ OVP SL 230VUC 1,25A	10	8449090000

Type	Qty.	Order No.
MCZ OVP FILTER 24V 0,5A	10	8449100000

#### Note

#### Accessories

##### Note

End plate  
AP MCZ 1,5 SW: 1046410000

End plate  
AP MCZ 1,5 SW: 1046410000



## MCZ OVP series

### 3- or 1-stage protection with tension clamp connection

- Slim overvoltage protection terminal with tension clamp connection
- 6 mm slim fine overvoltage protection
- Fast wiring thanks to TS contact and tension clamp connections

#### MCZ OVP 90 V

Gas discharge tube

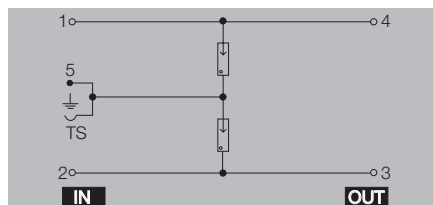

#### MCZ OVP S10K30

Varistor S10K30

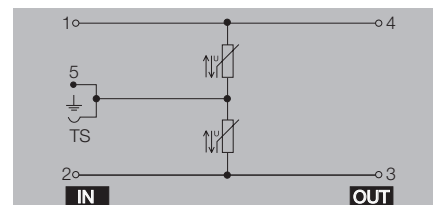

#### Technical data

Rated voltage (AC)  
 Rated voltage (DC)  
 Max. continuous voltage,  $U_c$  (AC)  
 Operating current,  $I_{max}$   
 Volume resistance  
 Gas discharge tube  
 Varistor  
 Suppression diodes  
 Limiting frequency (-3 dB) at load resistance  
 Discharge current, max. (8/20  $\mu$ s)  
 Lightning test current  $I_{imp}$  (10/350  $\mu$ s)  
 Requirements category acc. to IEC 61643-21  
 Design  
 Storage temperature  
 Ambient temperature (operational)

#### Protection level

Wire-PE 1kV/ $\mu$ s, typically  
 Wire-PE 8/20  $\mu$ s, typically  
 Wire-wire 1 kV/ $\mu$ s, typically  
 Wire-wire 8/20  $\mu$ s, typically

#### Approvals

Approvals

50 V  
 70 V  
 72 V  
 13 A  
 0.20  $\Omega$   
 Yes  
 No  
 No  
 5 kA  
 1 kA  
 D1  
 Terminal  
 -20 °C...+85 °C  
 -40 °C...+60 °C

700 V  
 800 V  
 700 V  
 800 V

CE; GOSTME25

24 V  
 24 V  
 30 V  
 13 A  
 0.20  $\Omega$   
 No  
 Yes  
 No  
 125 A  
 < 0.5 kA  
 Terminal  
 -20 °C...+85 °C  
 -40 °C...+60 °C

45 V  
 55 V  
 45 V  
 55 V

CE; GOSTME25

#### Dimensions

Height x width x depth mm

91 / 6 / 63.5

91 / 6 / 63.5

#### Note

See derating curve in the introduction to this catalogue

See derating curve in the introduction to this catalogue

#### Ordering data

Type	Qty.	Order No.
MCZ OVP GASABLEITER 90V	10	8449130000

Type	Qty.	Order No.
MCZ OVP VARISTOR S10K30	10	8449140000

#### Note

#### Accessories

#### Note

End plate  
 AP MCZ 1,5 SW: 1046410000

End plate  
 AP MCZ 1,5 SW: 1046410000

### 3- or 1-stage protection with tension clamp connection

- Slim overvoltage protection terminal with tension clamp connection
- 6 mm slim fine overvoltage protection
- Fast wiring thanks to TS contact and tension clamp connections

### MCZ OVP TAZ 24 V DC

Diode unipolar

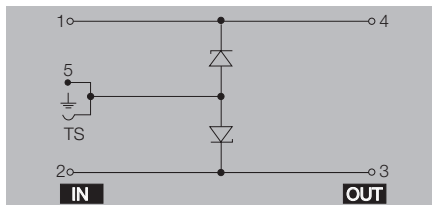

### MCZ OVP TAZ 24 V UC

Diode bipolar

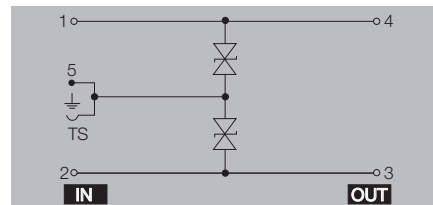

#### Technical data

Rated voltage (AC)  
 Rated voltage (DC)  
 Max. continuous voltage,  $U_c$  (AC)  
 Operating current,  $I_{max}$   
 Volume resistance  
 Gas discharge tube  
 Varistor  
 Suppression diodes  
 Limiting frequency (-3 dB) at load resistance  
 Discharge current, max. (8/20  $\mu$ s)  
 Lightning test current  $I_{imp}$  (10/350  $\mu$ s)  
 Requirements category acc. to IEC 61643-21  
 Design  
 Storage temperature  
 Ambient temperature (operational)

#### Protection level

Wire-PE 1kV/ $\mu$ s, typically  
 Wire-PE 8/20  $\mu$ s, typically  
 Wire-wire 1 kV/ $\mu$ s, typically  
 Wire-wire 8/20  $\mu$ s, typically

#### Approvals

Approvals

24 V  
 30 V  
 13 A  
 0.20  $\Omega$   
 No  
 No  
 Yes

112 A

Terminal  
 -40 °C...+85 °C  
 -40 °C...+60 °C

55 V  
 65 V  
 55 V  
 65 V

CE; GOSTME25

24 V  
 27 V  
 27 V  
 13 A  
 0.20  $\Omega$   
 No  
 No  
 Yes

0.5 kA

Terminal  
 -40 °C...+85 °C  
 -40 °C...+60 °C

110 V  
 130 V  
 55 V  
 65 V

CE; GOSTME25

#### Dimensions

Height x width x depth mm

91 / 6 / 63.5

91 / 6 / 63.5

#### Note

See derating curve in the introduction to this catalogue

See derating curve in the introduction to this catalogue

#### Ordering data

Type	Qty.	Order No.
MCZ OVP TAZ DIODE 24VDC	10	8449150000

Type	Qty.	Order No.
MCZ OVP TAZ DIODE 24VUC	10	8449160000

#### Note

#### Accessories

#### Note

End plate  
 AP MCZ 1,5 SW: 1046410000

End plate  
 AP MCZ 1,5 SW: 1046410000

## RS series

### 3-stage protection with screw connection

- RSU overvoltage protection for power supplies
- With current-compensated inductor
- Low residual voltage due to suppression diodes

#### RSU 24 V UC 6 A

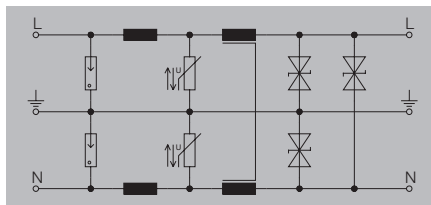

#### RSU 115 V UC 6 A

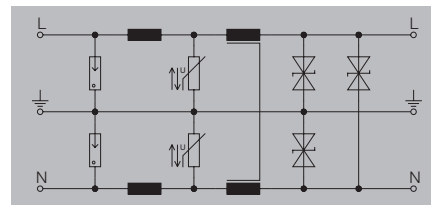

B



#### Technical data

Rated voltage (AC)
Rated voltage (DC)
Max. continuous voltage, U <sub>c</sub> (AC)
Operating current, I <sub>max</sub>
Volume resistance
Gas discharge tube
Varistor
Suppression diodes
Limiting frequency (-3 dB) at load resistance
Discharge current, max. (8/20 μs)
Design
Type of connection
Ambient temperature (operational)
Storage temperature

#### Protection level

Wire-PE 1kV/μs, typically
Wire-PE 8/20 μs, typically
Wire-wire 1 kV/μs, typically
Wire-wire 8/20 μs, typically

#### Approvals

Approvals

24 V
24 V
27 V
6 A
0.08 Ω
Yes
Yes
Yes
8 kHz 4 Ω
24 kA
RS section
Screw connection
-25 °C...+40 °C
-25 °C...+85 °C

40 V
45 V
40 V
45 V

CE; GOSTME25

115 V
115 V
130 V
6 A
0.08 Ω
Yes
Yes
Yes
30 kHz 20 Ω
24 kA
RS section
Screw connection
-25 °C...+40 °C
-25 °C...+70 °C

200 V
250 V
200 V
250 V

CE; GOSTME25

#### Dimensions

Height x width mm

87 / 81

87 / 81

#### Note

#### Ordering data

Type	Qty.	Order No.
RSU 24VUC 6A LP	1	1171361001

Type	Qty.	Order No.
RSU 115VUC 6A	1	1171561001

#### Note

#### Accessories

#### Note

**3-stage protection with screw connection**

- RSU overvoltage protection for power supplies
- With current-compensated inductor
- Low residual voltage due to suppression diodes

**RSU 230 V UC 6 A**

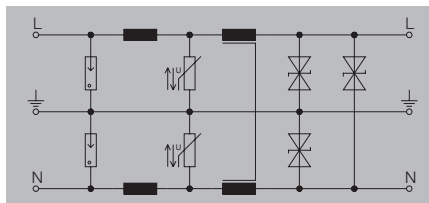

**Technical data**

Rated voltage (AC)  
 Rated voltage (DC)  
 Max. continuous voltage,  $U_c$  (AC)  
 Operating current,  $I_{max}$   
 Volume resistance  
 Gas discharge tube  
 Varistor  
 Suppression diodes  
 Limiting frequency (-3 dB) at load resistance  
 Discharge current, max. (8/20  $\mu$ s)  
 Design  
 Type of connection  
 Ambient temperature (operational)  
 Storage temperature

230 V  
 230 V  
 250 V  
 6 A  
 0.08  $\Omega$   
 Yes  
 Yes  
 Yes  
 90 kHz 40 k $\Omega$   
 24 kA  
 RS section  
 Screw connection  
 -25 °C...+40 °C  
 -25 °C...+70 °C

**Protection level**

Wire-PE 1 kV/ $\mu$ s, typically  
 Wire-PE 8/20  $\mu$ s, typically  
 Wire-wire 1 kV/ $\mu$ s, typically  
 Wire-wire 8/20  $\mu$ s, typically

400 V  
 420 V  
 400 V  
 420 V

**Approvals**

Approvals

CE; GOSTME25

**Dimensions**

Height x width mm

87 / 81

**Note**

**Ordering data**

Type	Qty.	Order No.
RSU 230VUC 6A LP	1	1171661001

**Note**

**Accessories**

**Note**

## RS series

### 3-stage protection with screw connection

- RSU overvoltage protection for power supplies
- With current-compensated inductor
- Low residual voltage due to suppression diodes

#### RSU 115 V UC 10 A



#### RSU 230 V UC 10 A



B

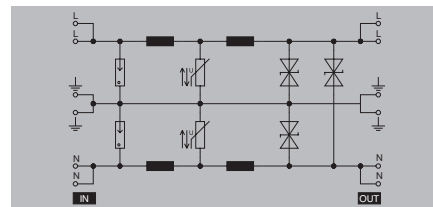
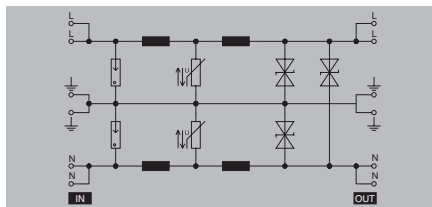

#### Technical data

Rated voltage (AC)	115 V
Rated voltage (DC)	115 V
Max. continuous voltage, U <sub>c</sub> (AC)	130 V
Operating current, I <sub>max</sub>	10 A
Volume resistance	0.04 Ω
Gas discharge tube	Yes
Varistor	Yes
Suppression diodes	Yes
Limiting frequency (-3 dB) at load resistance	30 kHz 20 Ω
Discharge current, max. (8/20 μs)	24 kA
Design	RS section
Type of connection	Screw connection
Ambient temperature (operational)	-25 °C...+40 °C
Storage temperature	-25 °C...+70 °C
<b>Protection level</b>	
Wire-PE 1kV/μs, typically	200 V
Wire-PE 8/20 μs, typically	250 V
Wire-wire 1 kV/μs, typically	200 V
Wire-wire 8/20 μs, typically	250 V
<b>Approvals</b>	
Approvals	CE; GOSTME25

Rated voltage (AC)	230 V
Rated voltage (DC)	230 V
Max. continuous voltage, U <sub>c</sub> (AC)	250 V
Operating current, I <sub>max</sub>	10 A
Volume resistance	0.04 Ω
Gas discharge tube	Yes
Varistor	Yes
Suppression diodes	Yes
Limiting frequency (-3 dB) at load resistance	90 kHz 40 kΩ
Discharge current, max. (8/20 μs)	24 kA
Design	RS section
Type of connection	Screw connection
Ambient temperature (operational)	-25 °C...+40 °C
Storage temperature	-25 °C...+70 °C
<b>Protection level</b>	
Wire-PE 1kV/μs, typically	400 V
Wire-PE 8/20 μs, typically	420 V
Wire-wire 1 kV/μs, typically	400 V
Wire-wire 8/20 μs, typically	420 V
<b>Approvals</b>	
Approvals	CE; GOSTME25

Rated voltage (AC)	230 V
Rated voltage (DC)	230 V
Max. continuous voltage, U <sub>c</sub> (AC)	250 V
Operating current, I <sub>max</sub>	10 A
Volume resistance	0.04 Ω
Gas discharge tube	Yes
Varistor	Yes
Suppression diodes	Yes
Limiting frequency (-3 dB) at load resistance	90 kHz 40 kΩ
Discharge current, max. (8/20 μs)	24 kA
Design	RS section
Type of connection	Screw connection
Ambient temperature (operational)	-25 °C...+40 °C
Storage temperature	-25 °C...+70 °C
<b>Protection level</b>	
Wire-PE 1kV/μs, typically	400 V
Wire-PE 8/20 μs, typically	420 V
Wire-wire 1 kV/μs, typically	400 V
Wire-wire 8/20 μs, typically	420 V
<b>Approvals</b>	
Approvals	CE; GOSTME25

<b>Dimensions</b>	
Height x width	mm

Height x width	105 / 105
----------------	-----------

Height x width	105 / 105
----------------	-----------

<b>Note</b>	
-------------	--

--	--

--	--

#### Ordering data

--	--	--

Type	Qty.	Order No.
RSU 115VUC 10A	1	8104221001

Type	Qty.	Order No.
RSU 230VUC 10A LP	1	8093281001

<b>Note</b>	
-------------	--

--	--

--	--

#### Accessories

<b>Note</b>	
-------------	--

--	--

--	--





# Differences between earthing and shielding

The terms “earthing” and “shielding” are classified according to their relation to human safety or facility safety. The earth is installed primarily to protect human life and for this reason is referred to as the protective earth conductor. On the other hand, shielding is used to ensure that the electrical system functions properly. It also ensures electromagnetic compatibility.

These main differences between the two terms influence the electrical design and installation. Shielding is not designed to transfer power, although leakage currents may flow on them. A protective earth conductor, however, must be able to briefly discharge a high fault current (IEC 60947-7-2). The short-term current resistance of the PE connection must be 120 A/mm<sup>2</sup> for the connected cross-section.

The illustration below shows how these two topics relate to each other in application.

As shown in the picture below, the cable’s shielding is connected to the earth potential so that the shield’s current can be discharged. Depending on the sensitivity of the facility, isolated areas of potential can be created. However it is still typical to mix the areas, so that the shielding is on a common equipotential earth. This illustration shows how the number of shields and PE conductors that need to be connected can increase quite rapidly (in this case only one component is used). The shielding and earthing systems must be planned carefully to provide adequate safeguards for personnel and equipment. The following sections describe the complexity and uniqueness in more detail.

Different symbols are also used for the two themes:



Shielding



Earthing

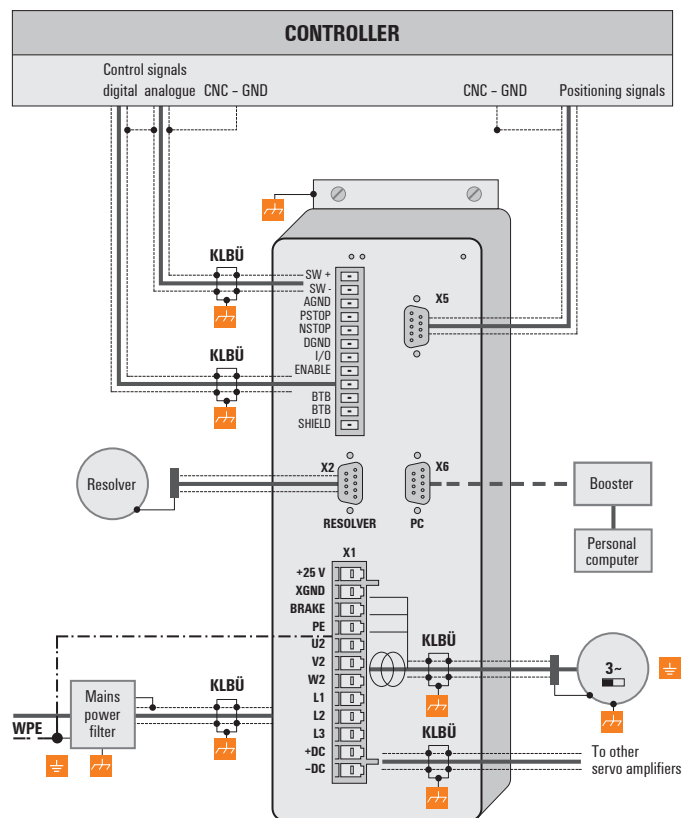

Connection diagram for a frequency converter

## Earthing for shielded cables

Electrical and electronic systems should be designed and installed so that they are essentially protected against electrical interference, so that they also function reliably in the event of transient interference voltages.

Electrical interference is introduced into circuits in many different ways. The most frequent cause is inductive interference effects. However, conductive or capacitive coupling plus electrical fields and other phenomena can also cause interference voltages. In these cases high-frequency voltage oscillations – the so-called transients – are very likely the cause of the interference.

### Shielded lines enhance interference immunity

The sources of interference voltages can never be eliminated completely. Therefore, we have to take measures to deal with their effects. Generally, it is true to say that the more effectively we can keep interference voltages away or discharge them from circuit elements, the smaller are their disturbing effects. This can be done in many ways – with differing degrees of effectiveness. One really effective measure for protecting against inductive influences, i.e. guaranteeing the electromagnetic compatibility, is to shield the electric functional components at earth potential. One way of doing this is to install components in metal, earthed housings and to shield the connecting lines.

Generally, it is true to say that counteracting the interference effects of lines is feasible by laying the lines as far apart as possible, keeping the common return as short as practical, or using twisted lines. A far better method of protection, however, is to provide a continuous shield for all lines. This is the most effective measure that can be taken against the coupling together of interferences.

The best form of shielding consists of a braided hose of individual wires made from a non-magnetic material (copper, aluminium). The braiding should be sufficiently robust and as solid as possible. Care must be taken with lines protected by a foil shield because of the foil's low mechanical strength and low current-carrying capacity.

### Correct use of shielded lines

Adding shielding to lines achieves the desired effect only when they are properly designed and installed. Incorrect earthing or the use of components that do not function satisfactorily reduce the effect or even nullify it altogether. It is not sufficient to connect the shielding to earth potential at just any point because it could be the case that this earth connection is inadequate for high frequencies. In addition, we must also watch out for earth loops, the shielding must be earthed over a large area, and the quality of the shield bonding lines and earthing accessories is also important.



# Shielding



In practice, the shield is often twisted and connected to a terminal point. There is very high attenuation (voltage drop) on these connections, especially for high-frequency interference. Therefore this type of shielding should not be used, even for short cable lengths. The cable shield is practically negated and can, at best, be helpful for low-frequency interference. We recommend a large, extensive contact with the braided shield of the cable.

There are four main types of coupling:

- Galvanic coupling
- Capacitive coupling
- Inductive coupling
- Radiation coupling

Such interferences usually occur mixed together, but they can be categorised as follows:

- Electromagnetic fields
- Ripple voltage (50 Hz)
- Lightning
- Interference pulses (current, voltage)
- Transient surge voltages
- Radio interference
- ESD (electrostatic)
- Burst
- Mains feedback

The conductor "flow" is another detail for concern with the shield contact. The temperature changes caused by the current flow lead to changes in the wire's diameter. A rigid contact can therefore only be partially effective. A self-adjusting contact is what is really required. Weidmüller's clamping yoke products (KLBÜ) provide the perfect solution for this challenge.

The following pictures show examples of use:

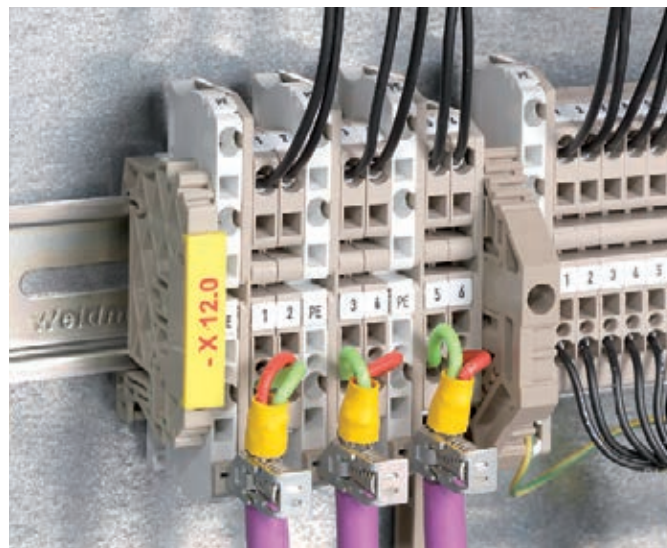

Shield connection via functional earth

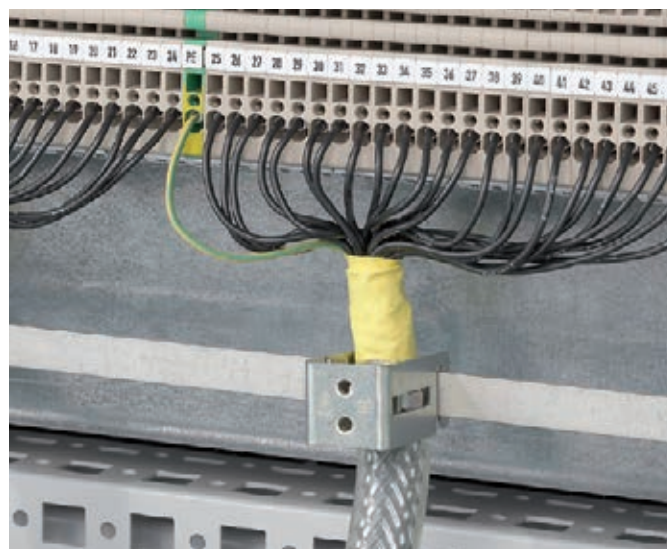

Shield connection on common earth

**Effective shielding**

It is important to remember that the shielding should not be connected to the earth of the module connected, but rather to the protective earth (PE). In the case of modules mounted in an earthed, metal housing, the shielding must be connected to this housing. If an earthed housing is not available, the shielding must be connected to a separate earth.

When laying earth connections to shields it must also always be ensured that no earth loops are formed. The smaller the earth loop, the lower is the risk of inducing interference voltages. Therefore, a true star arrangement is the best answer.

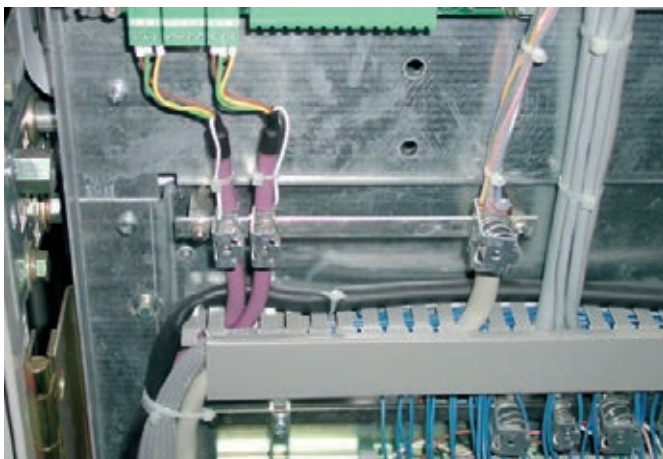

The sketches below show general, feasible connections between shield and protective earth.

Connecting the shield at one end protects against capacitive-coupled interference voltages.

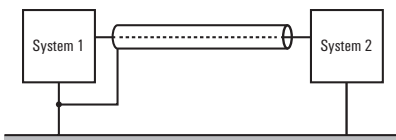

Connecting the shield at both ends is suitable for protecting against inductive-coupled interference fields.

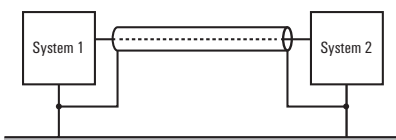

A high-resistance connection at one end of the shield is recommended when trying to avoid the disadvantages of forming an earth loop in the case of shields connected at both ends.

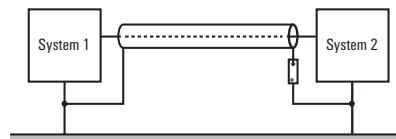

On longer shielded lines, e.g. when a sensor has to be routed to the control room, the potential difference between the two ends should not be ignored. If a current-carrying shield bonding line is used, it is possible to compensate for the potential difference between the measuring point and the control room by means of this shield. However, such shield lines are relatively expensive and also complicated to fabricate and install. Another possibility is to lay an additional equipotential bonding line between the measuring point and the control room. The shield can then be connected at both ends.

Yet another possibility is a high-resistance earth. The shield is then connected to earth potential in the control room, and at the measuring point connected to earth via a gas discharge tube in a high-resistance arrangement. This solves the problems of potential transfer and a 50 Hz hum.

Two gas discharge tubes must be installed for non-floating measuring points. One connects the shield to earth and the other to the non-floating measuring point. This prevents conductive coupling between the measuring circuit and the earthed measuring point.

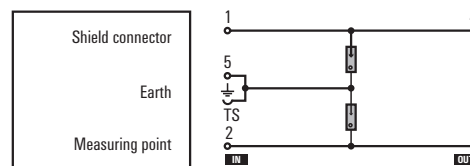

**Summary**

The earthing is an important factor affecting the reliable operation of electrical installations in the event of interference effects. RF aspects must be taken into account. Only the correct use of materials and well-thought-out circuit design can bring success.



B

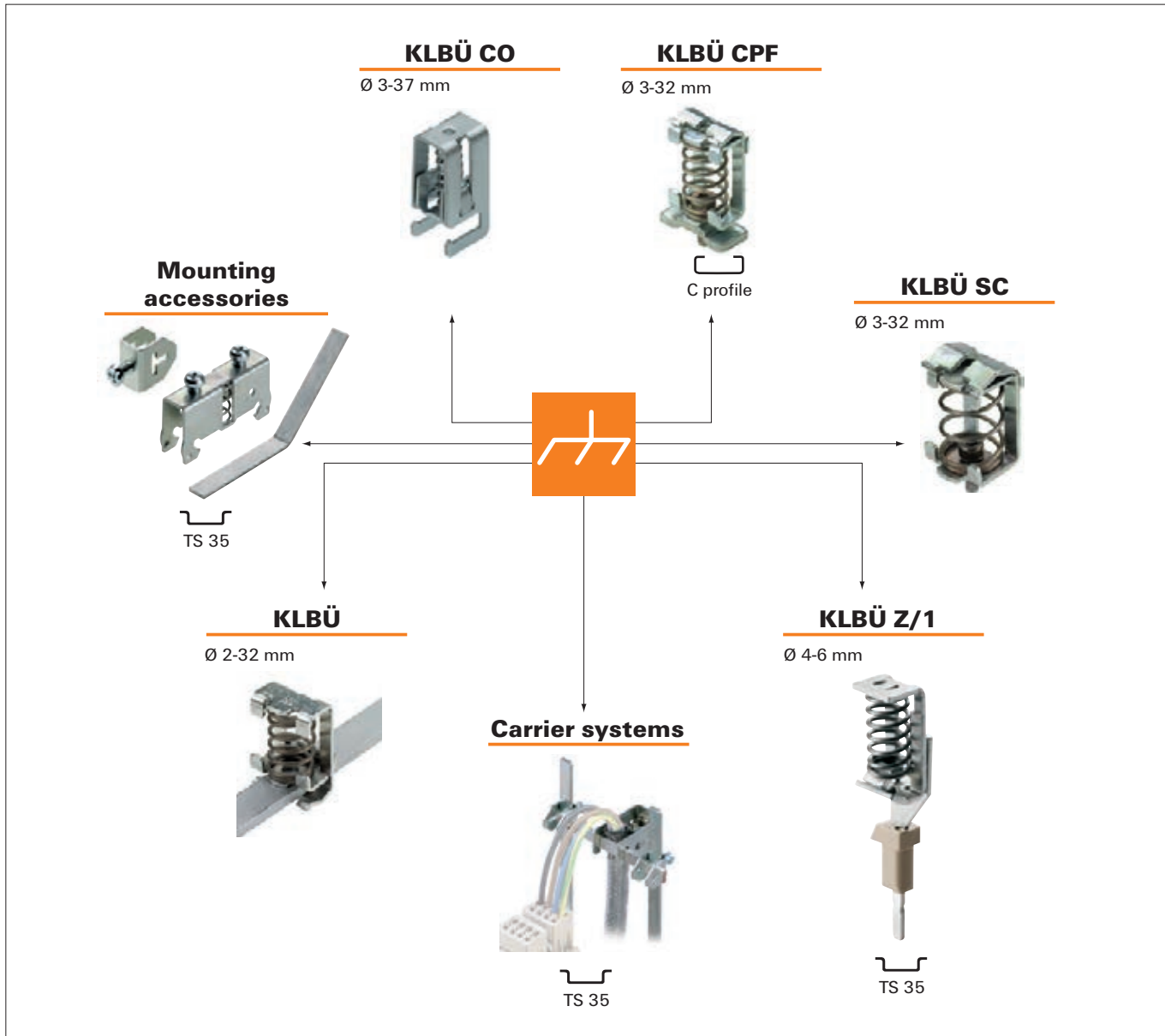

Overview of products for shielding connections



Please refer to our Terminal Block Catalogue for more information.  
**Order number: 1282250000**



**Shield for the VSPC surge protector is easily connected with the EMC SET**

The EMC SET allows you to easily integrate the shield on measurement/control cables into your overall protective strategy.

The set includes the metal part (connector) and the shielded cable tie (TIE). It is combined on-site with the plastic stabiliser and can then be inserted into terminal 3 or 9. Up to two shielded cables (from 3 to 8 mm) can easily be attached there.

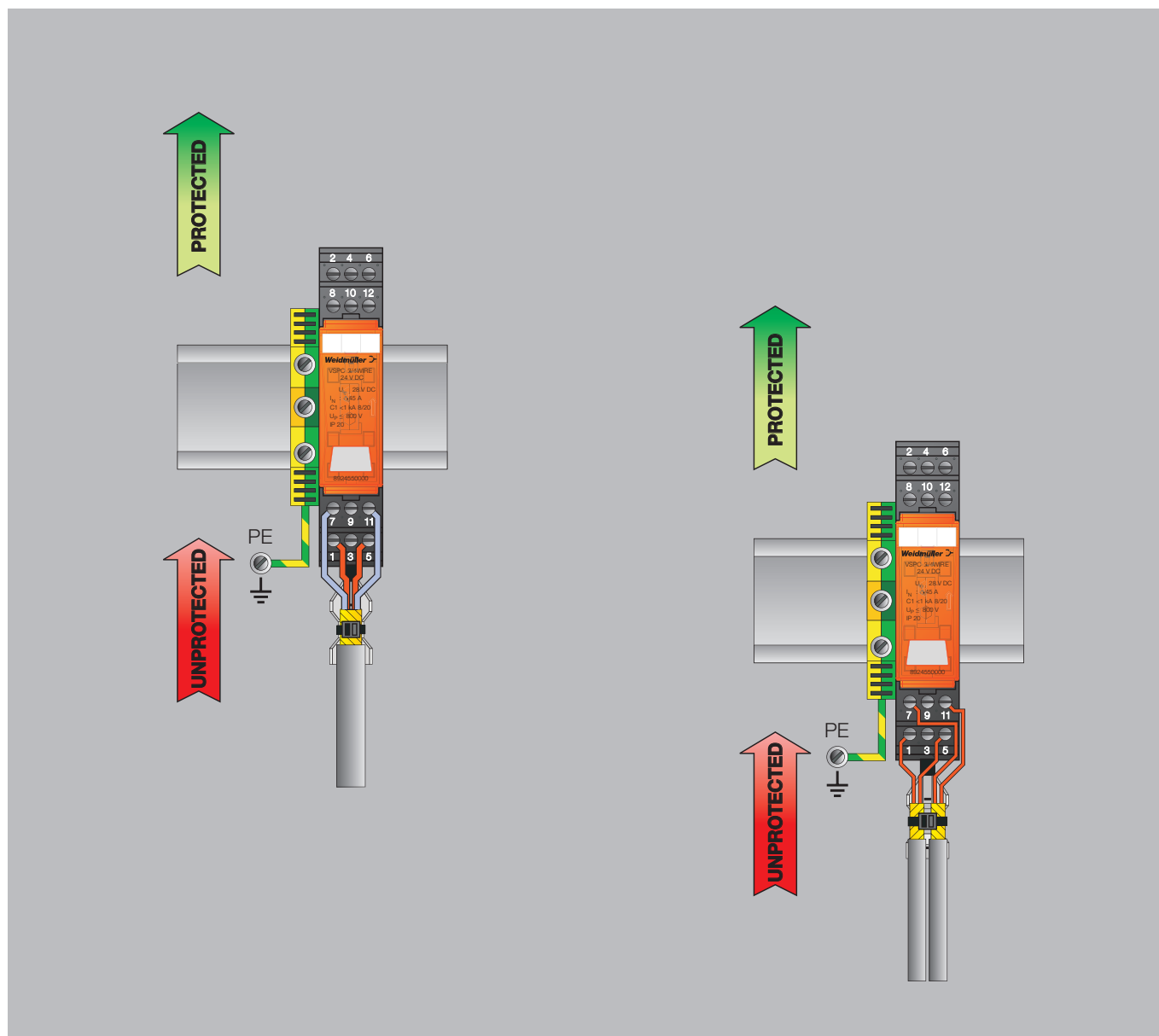
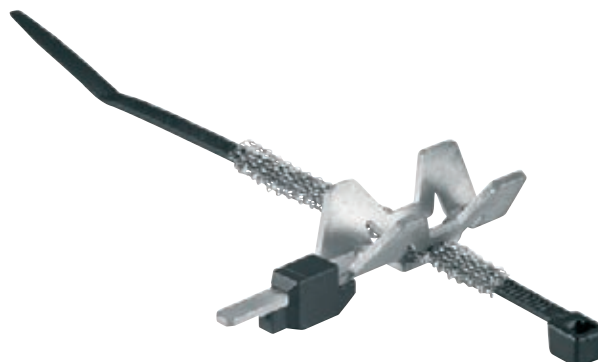

# Installation advice for instrumentation and control engineering

The supply and earth lines to protective modules should be kept short in order to achieve optimum protection for equipment.

The fuses for the protective modules should be chosen depending on the rated current as well as on the type of line and its route.

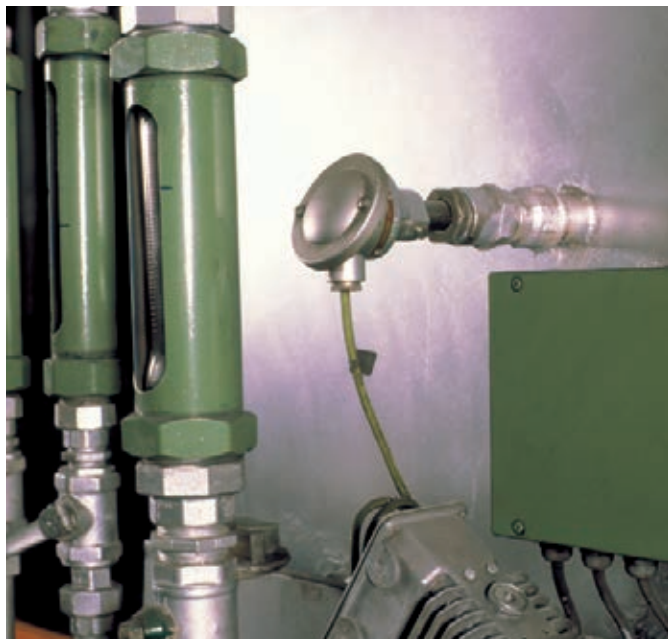

## Installation position

The protective modules are frequently installed at both ends of the line.

It is important to ensure that protected and unprotected lines are routed separately. In addition, there must be some distance between power lines and data lines. A common cable duct should be connected with metal partitions.

The protective modules should be mounted in a panel near the entry point of the lines. Unprotected lines should not be fed into parts of the system. Therefore, the lower level in the panel should be used for the protective modules.

## Mounting rail contact as earth in connection for MCZ OVP

Contact to the rail is automatically established using the snap-on attachment. The TS35 rail must be earthed in order to ensure safe power discharging via the surge protection elements of up to 20 kA (8/20  $\mu$ s) and 2.5 kA (10/350  $\mu$ s). The DIN rail should be screwed onto the earthed mounting plate to ensure EMC. It is also possible to contact the PE every 60 cm / 24 inch using the tension-clamp terminal on the MCZ OVP.

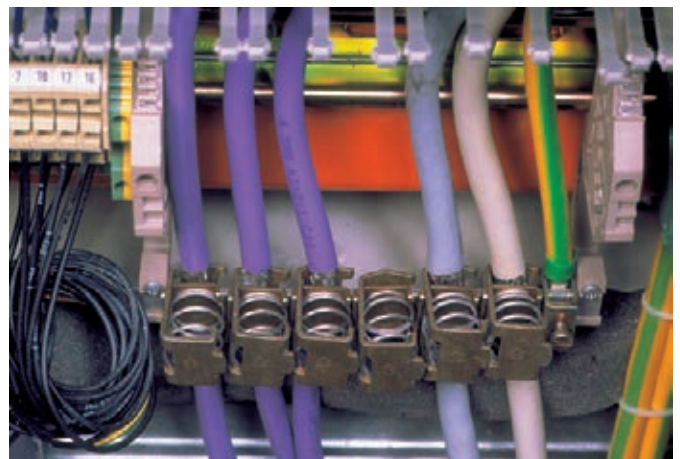

The shielded signal lines should be connected to PE via terminal clamps (Weidmüller KLBÜ). Unshielded lines should be twisted. Neutral earthing is preferred. All the protective modules belonging to one part of the system should have neutral earthing. A through-connection of the earth line should be avoided.

Protected and unprotected lines must be laid separately. A common cable duct should be connected with metal partitions.

Likewise, signal and power lines should be laid separately. Electrical isolation, e.g. with relay couplers or analogue converters, should be employed for installations involving several buildings. This avoids interference currents via minus, PE or N.

The supply and earth lines to protective modules should be kept short in order to achieve optimum protection for equipment. Transmission paths should also be kept as short as possible because the longer the line, the greater is the chance that interference can affect the line. The inclusion of surge protection also increases the attenuation of the line and therefore changes the signal-to-noise ratio.



### Surge protection for binary signals

The VSPC 4 SL plug-in surge protector can be used to protect the 24-V supply and also the 24-V switching signals.

The unprotected side points in the direction where the pulse or interference is expected. The connecting cable's shield is connected to terminal 3 (the EMC set can be used).

The earthed DIN rail can then pick up the pulse and discharge it to the earth.

For long cables, and especially for current loops, additional protection is set-up at the sensors. The VSPC BASE FG floating-earth base can be used there. A built-in gas discharge tube makes this a "high impedance" earth, which prevents an interference current on the shield.

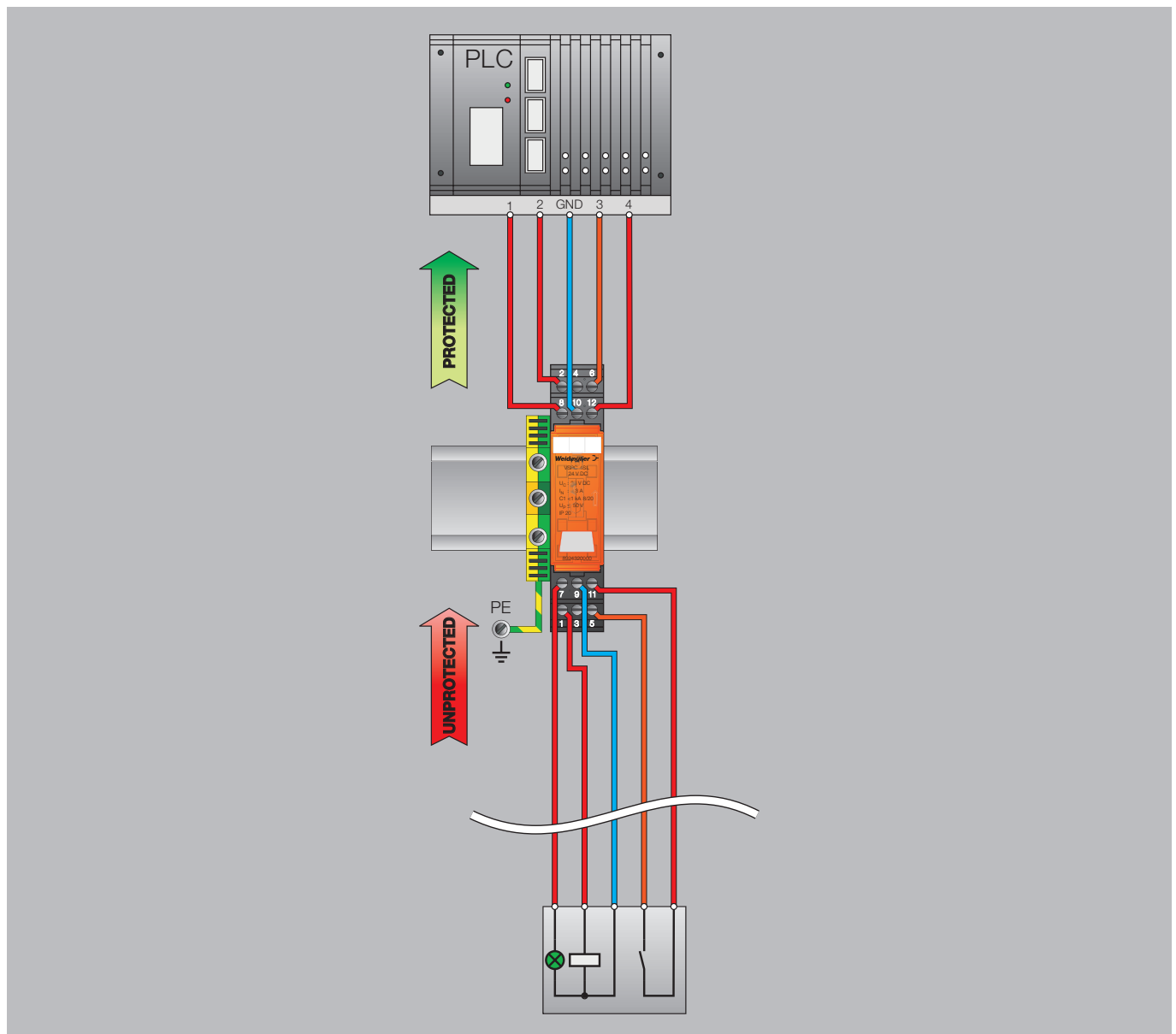

**B**

**Surge protection for sensors with current loop output 0 (4)...20 mA**

VSPC 2CL plug-in surge protector for protecting two current loops with 0 (4)...20 mA.

The unprotected side points in the direction where the pulse or interference is expected. The connecting cable's shield is connected to terminal 3 (the EMC set can be used).

The earthed DIN rail can then pick up the pulse and discharge it to the earth.

For long cables, and especially for current loops, additional protection is set-up at the sensors. The VSPC BASE FG floating-earth base can be used there. A built-in gas discharge tube makes this a "high impedance" earth, which prevents an interference current on the shield.

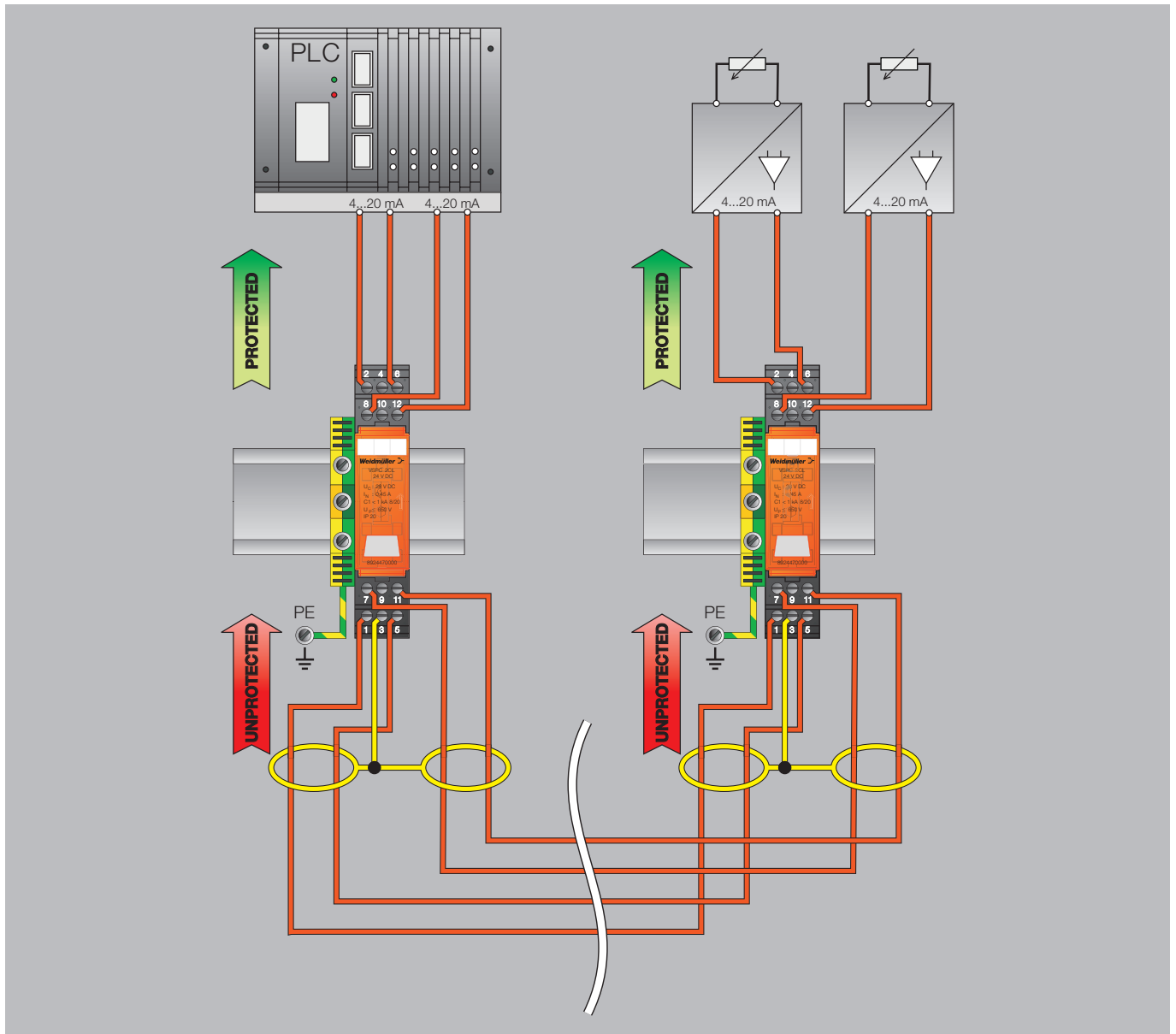

**Surge protection for sensors with supply voltage and a current loop 0 (4)...20 mA**

The VSPC 1CL PW plug-in surge protector uses a Type III arrester to protect the 24-V supply voltage and also a D1/C2/C1-arrester for the current loop 0 (4)...20 mA. This 17.5-mm configuration protects both power and measurement/control (e.g. for a pumping facility).

The unprotected side points in the direction where the pulse or interference is expected. The connecting cable's shield is connected to terminal 3 (the EMC set can be used). The earthed DIN rail can then pick up the pulse and discharge it to the earth.

For long cables, and especially for current loops, additional protection is set-up at the sensors. The VSPC BASE FG floating-earth base can be used there. A built-in gas discharge tube makes this a "high impedance" earth, which prevents an interference current on the shield.

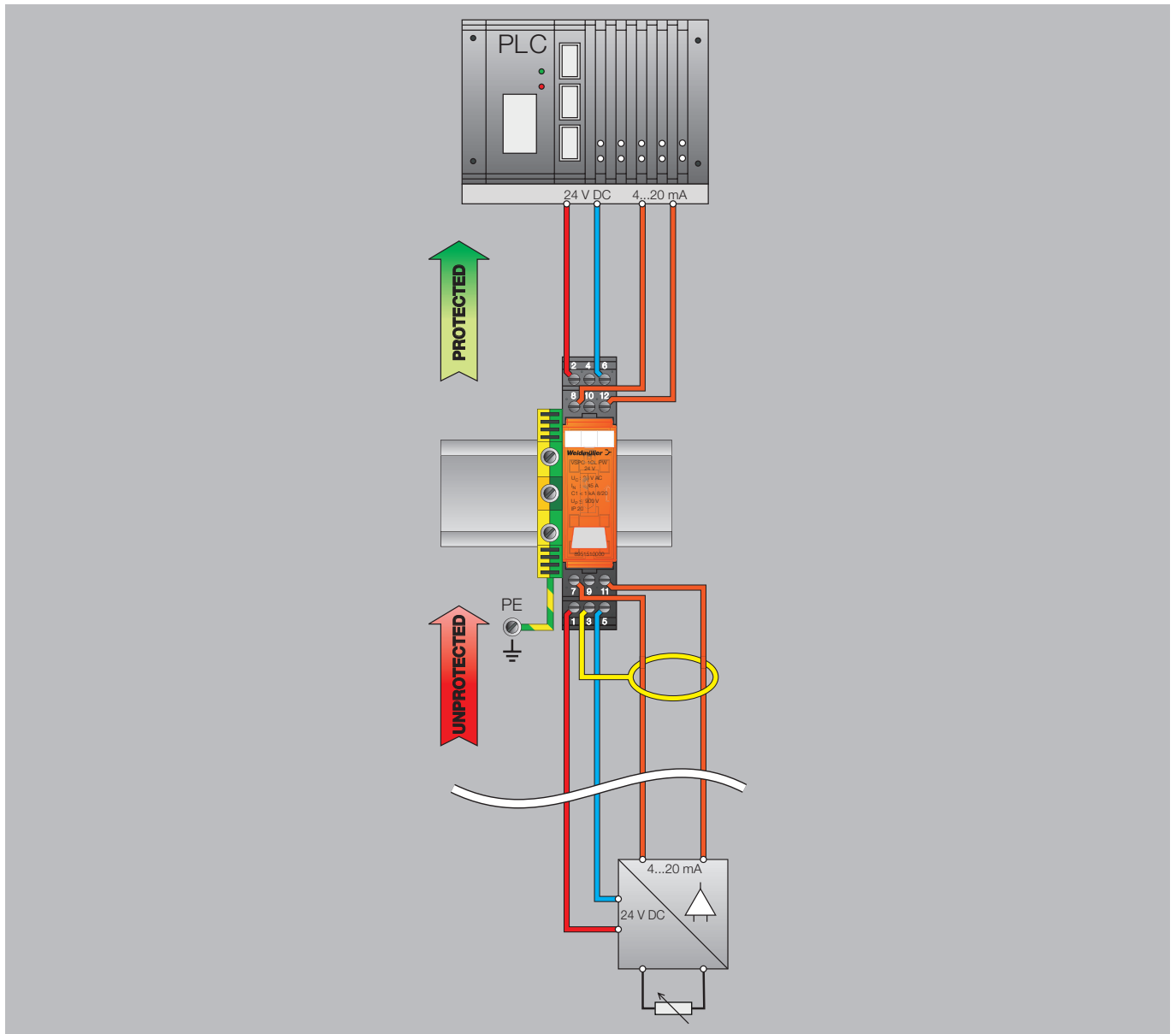

**B**



**Surge protection for sensors with 4-wire connection or temperature measurement**

The plug-in VSPC 3/4 surge protector is used to protect 3- or 4-wire measurement signals (e.g. from temperature sensors or load cells).

The unprotected side points in the direction where the pulse or interference is expected. The connecting cable's shield is connected to terminal 3 (the EMC set can be used).

The earthed DIN rail can then pick up the pulse and discharge it to the earth.

For long cables, and especially for current loops, additional protection is set-up at the sensors. The VSPC BASE FG floating-earth base can be used there. A built-in gas discharge tube makes this a "high impedance" earth, which prevents an interference current on the shield.

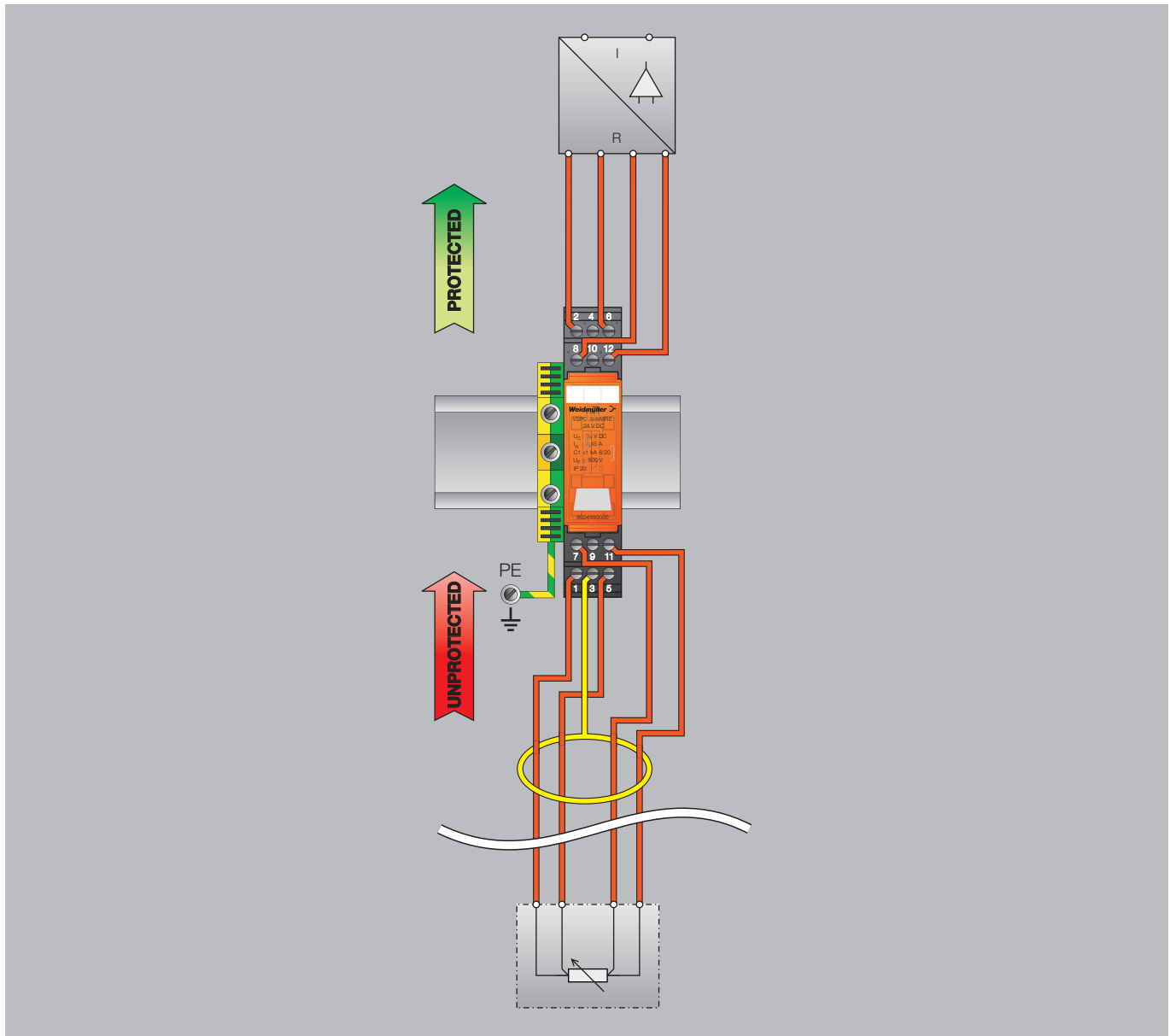

### Surge protection for telephone signals $U_{ko}$

The VSPC  $U_{ko}$  plug-in surge protector is used to protect up to two phone lines with up to 4 wires.

The unprotected side points in the direction where the pulse or interference is expected. The connecting cable's shield is connected to terminal 3 (the EMC set can be used). The earthed DIN rail can then pick up the pulse and discharge it to the earth.

For long cables, and especially for current loops, additional protection is set-up at the sensors. The VSPC BASE FG floating-earth base can be used there. A built-in gas discharge tube makes this a "high impedance" earth, which prevents an interference current on the shield.

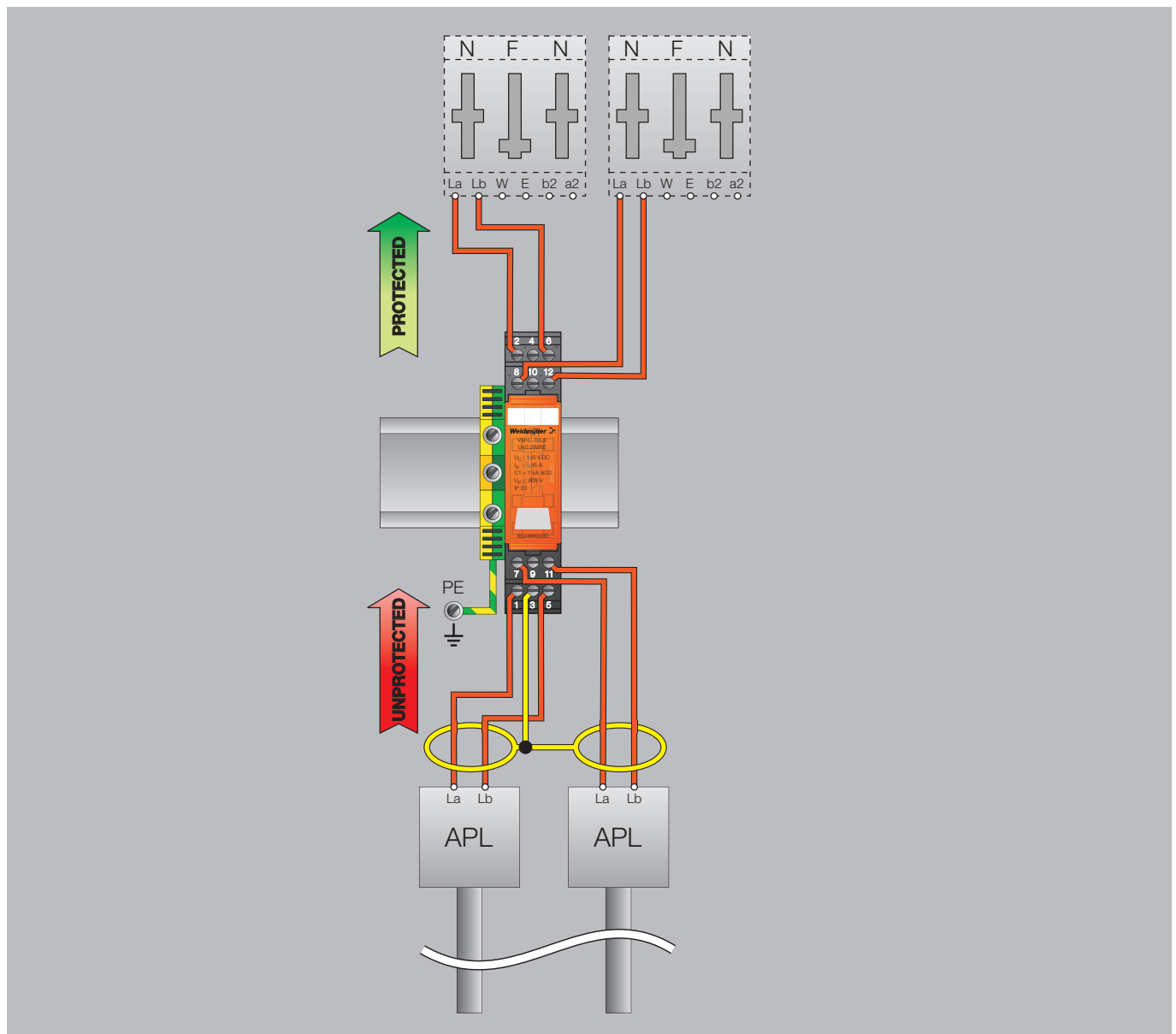

### Surge protection for data lines, RS485 or RS422

The VSPC RS485 plug-in surge protector is used to protect an RS485 data line or two RS422 data lines.

**B**

The unprotected side points in the direction where the pulse or interference is expected. The connecting cable's shield is connected to terminal 3 (the EMC set can be used). The earthed DIN rail can then pick up the pulse and discharge it to the earth.

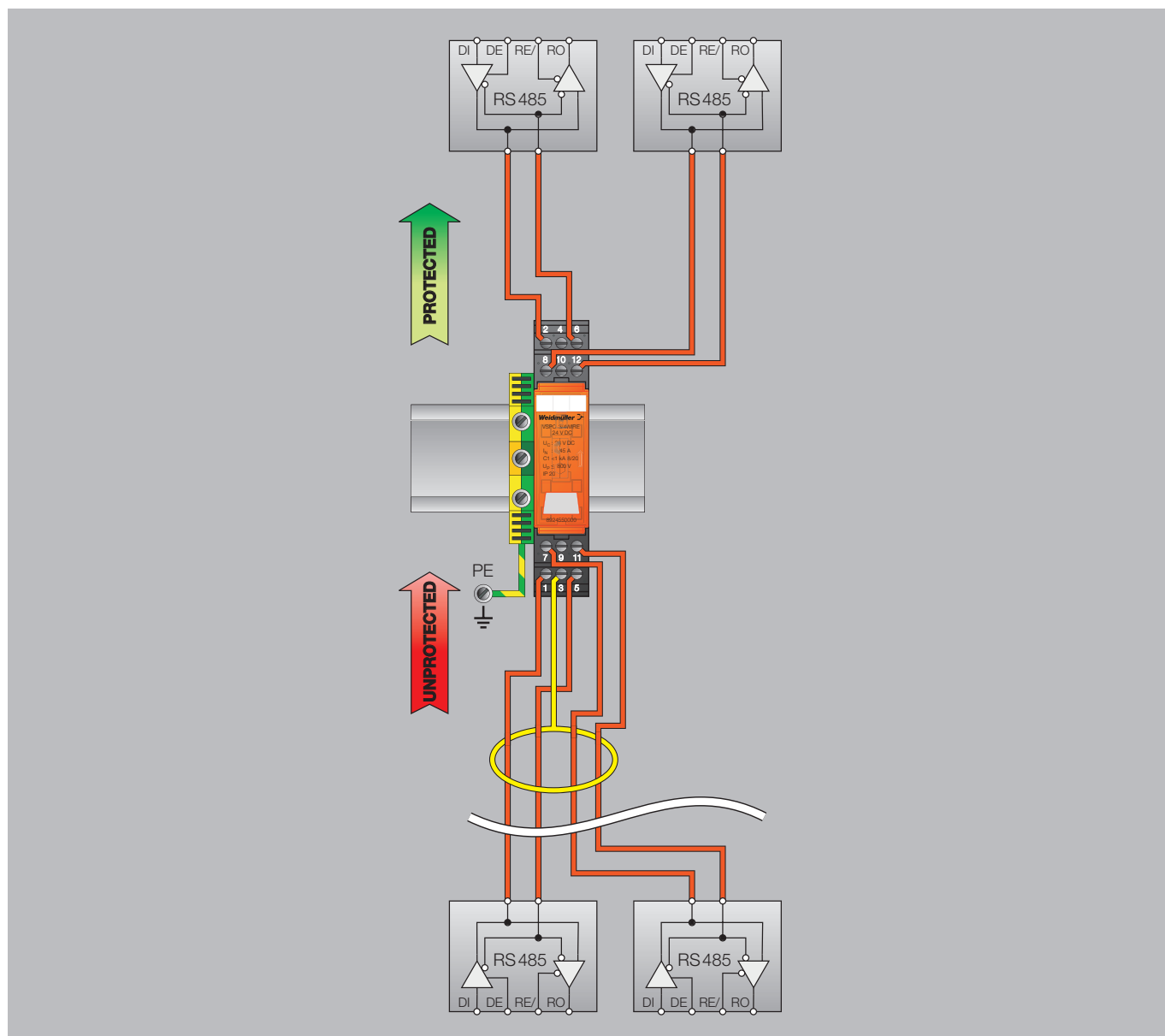



# VARITECTOR SPC EX



## Pluggable surge protection for measurement and control systems

### VARITECTOR SPC EX

Weidmüller's VARITECTOR SPC EX pluggable surge protector is remarkable for its combination of extremely high protective functionality and compact dimensions. It protects intrinsically safe measurement and control circuits. The size is made possible by the selection of INSTA dimensions, with a width of 17.8 mm (1 TE). You save time on connections because of the screw connection and the indirect earthing contact via the DIN rail. The VARITECTOR SPC series is optimally designed for compact installations in process automation, industrial automation and building automation. The two-stage surge protection terminals are equipped with gas discharge tubes, suppressor diodes (TVS) and decoupling components. IEC 62305 requires that a periodic inspection of surge protection products be conducted. The functionality of all VARITECTOR SPC modules can be tested using testing equipment (such as the V-TEST) that is available separately.

You can get our VARITECTOR SPC surge protection series in the nominal voltages of 5 V, 12 V and 24 V. The product's voltage level is colour-coded on the pluggable arrester.

It can be snapped on an earthed DIN for indirect earthing. The TS 35 must be earthed in order to ensure safe power discharging via the terminals of up to 20 kA (8/20  $\mu$ s) and 2.5 kA (10/350  $\mu$ s). The DIN rail must be screwed onto the earthed mounting plate to ensure EMC.

In order to optimise the protective function, the PE contact should be made every 60 cm / 24 inch using the terminal on the VARITECTOR SPC module.

A testing device, available as a Weidmüller accessory, allows you to test the protective element in compliance with the IEC 62305-3 directive. Accessories also include the EMC SET which provides a simple method for creating the cable shield.

## Overview of model types

Surge protection consists of a separate plug-in VARITECTOR SPC EX and a separate base unit VARITECTOR SPC BASE.

### ATEX



The VSPC EX series comes in a light blue housing and is used to protect electronics connected to intrinsically safe circuits. The unearthed (floating ground - FG) VARITECTOR SPCs have negligible internal inductance and capacitance.

### Labelling of the VSPC EX equipment

#### ATEX:

For gas  
T II 1 G Ex ia IIC T4 ... T6 Ga or  
For dust  
T II 1 D Ex ia IIIC T135°C ... T85°C Da  
KEMA 10 ATEX 0148 X

#### IEC EX:

For gas  
Ex ia IIC T4 ... T6 Ga  
For dust  
Ex ia IIIC T135 °C ... T85 °C Da

The basic health and safety functions are fulfilled by compliance with:

EN 60079-0:2009,  
EN 60079-11:2007,  
EN 60079-26:2007 and  
EN 61241-11:2006, IEC 61643-21



VARITECTOR SPC EX



### Products for intrinsically safe circuits

VSPC 1CL 12 V ATEX  
and VSPC 1CL 24 V ATEX

This VSPC surge protector is used to protect an intrinsically safe current loop.

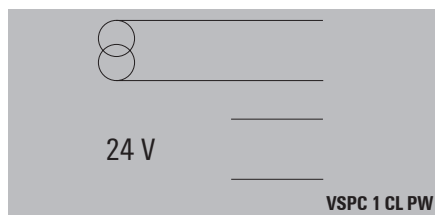

### VSPC EX 1 CL 24 V/Power ATEX

This VARITECTOR SPC surge protector protects an analogue signal and has an intrinsically safe power supply which is protected by a Type III end-device protection mechanism.

All in one product it is suitable for an intrinsically safe sensor, which also requires an intrinsically safe power supply.

### VSPC EX 2SL 12 V DC ATEX

### VSPC EX 2SL 12 V AC ATEX

### VSPC EX 2SL 24 V DC ATEX

These VSPC EX surge protection modules are used for protecting two intrinsically safe binary signals.

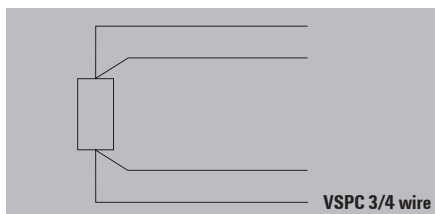

### VSPC EX 3/4 wire 5 V ATEX

This VSPC EX surge protector is suitable for 3- or 4-wire measurement systems with signals going in and out of the intrinsically safe zone.

### VSPC EX 1CL 5 V ATEX (Thermo)

This VSPC EX surge protector is suitable for Thermo temperature signals which goes in and out of the intrinsically safe zone.

### VSPC EX 1CL 12 V ATEX (Namur)

This VSPC EX surge protector is used to protect a Namur sensor signal in an intrinsically safe zone.

### Colour coding

The pluggable components transfer their coding to the BASE when they are plugged in for the first time. The voltage level is also marked with coloured Dekafix on the VSPC EX plug section. This gives you a better overview within the electrical cabinet.

Voltage level	Colour
≤ 12 V	green
24 V Binary	blue
24 V Analogue	yellow
Special function	white

### Testing option

Because the modules are pluggable, it is possible to test the VSPC EX using the V-TEST testing device. The user inserts the VSPC EX into the testing device for testing. The result is then shown on the display.

### Periodic inspections

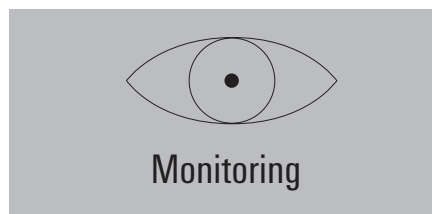

IEC 62305-3 requires testing and maintenance for lightning protection systems.

This includes the testing of the arresters used in the system.

Class of protection	Interval for complete testing	Interval for visual inspection
I	2 years	1 year
II	4 years	2 years
III/IV	6 years	3 years

**Caution!** These periodic inspections may be extended with stricter requirements pertaining to special applications or regions.

### Markers

The VSPC BASE lower section can be labelled with Dekafix 5 markers. The VSPC pluggable modules are colour coded with Dekafix 5 according to their nominal voltage.

### Installation

The VSPC EX series is used to protect signal circuits. In order to achieve a complete protective strategy for the facility, the power feed must be protected with Type II surge protection (for example, by using the VPU II series). For existing lightning protection facilities, Type I protection must be used (for example, by using the VPU I series).

When there is no lightning protection system, the Type II protection is sufficient (such as the VPU II).

# VARITECTOR SPC EX

## Discharge capacity

Testing is conducted using voltage and current pulses according to the IEC 61643-21 standard concerning surge protection in networks which process signals.

Category	Testing pulse	Surge voltage	Surge current	Pulse	Type
C1	Quick rising edge	0.5 < 2 kV with 1.2/50 µs	0.25 < 1 kA with 8/20 µs	300	Surge voltage arrester
C2	Quick rising edge	2 < 10 kV with 1.2/50 µs	1 < 5 kA with 8/20 µs	10	Surge voltage arrester
C3	Quick rising edge	≥ 1 kV with 1 kV/µs	10 < 100 A with 10/10.000 µs	300	Surge voltage arrester
D1	High power	≥ 1 kV	0.5 < 2.5 kA with 10/350 µs	2	Arrester for lightning current and surge voltages

Category C reflects the interference pulses with quick-rising edges and minimised power. Category D uses quick-rising edges and high power to detail the interference pulses. This energy simulates the high-power load that stems from coupled partial lightning currents.

## General technical data

Storage temperature: -40 °C...+80 °C  
Operating temperature: -40 °C...70 °C  
Humidity: 5 %...96 % RH without condensation  
Material: V0, IP 20

Wire connection: screw  
SD blade: 0.6 x 3.5 DIN 5264  
Nominal torque: 0.5 Nm  
Max. torque: 0.8 Nm  
Stripping length: 7 mm  
Solid core: 0.5...4 mm<sup>2</sup>  
Finely stranded: 0.5...2.5 mm<sup>2</sup>  
Ferrule with plastic collar:  
0.5...2.5 mm<sup>2</sup>

## Dimensions

Height: 90 mm  
Depth: 69 mm  
Width: 17,8 mm

## Accessories:

### Shield connection



EMC-SET (Order No. 1067470000)  
The EMC SET consists of a metal part with plastic guide and the cable ties sheathed with shielding braid.





# VARITECTOR SPC EX and ACT20X



## Pluggable surge protection and a universal signal converter for C&I signals in hazardous area applications

Intrinsically safe circuits to limit energy are used in hazardous areas. In these circuits, the intrinsically safe signal converters with their galvanic isolation and Exi approved surge arresters provide excellent protection for sensitive control electronics.

**B**

Surge voltages on the field side of the measurement and control lines can damage the facility. The VARITECTOR SPC EX can discharge surge voltages in hazardous area applications (zone 0, 1 and 2). The pluggable arresters conform to the requirements of the current standards with regards to Exi intrinsic safety. They also comply with the IEC 61643-21:2008 surge protection product standard and are certified for protection classes D1, C2 and C3.

The ACT20X-HUI-SAO-LP offers an intrinsically safe input for standard DC signals, temperature signals and resistance signals. It also isolates the Ex zone from the safe area. The 12.5 mm wide module is powered via the 4 ... 20 mA output. The global ATEX, IECEx and cULus Ex approvals allow it to be used throughout the world.

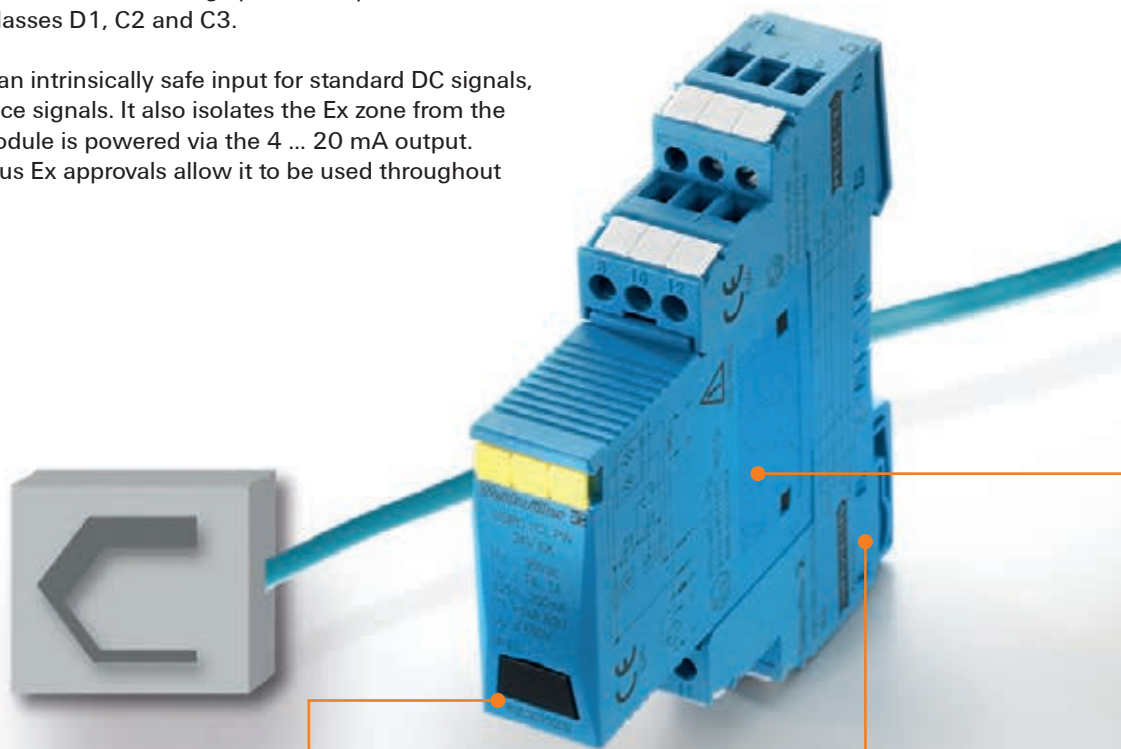

**Space saving**

The VSPC EX uses less space in the electrical cabinet, with four binary or two analogue signals in only 17.8 mm width.

**Unlimited protection**

The VSPC EX products are special, intrinsically safe surge arresters. Low Li and Ci values mean they are not relevant for the entire application's proof of intrinsic safety.

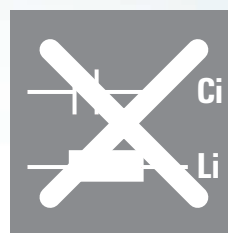



**Hazardous area applications**

The ACT20X signal converter is approved for installation in zone 2 and converts signals from zones 0, 1 or 2 for the controller. The product is approved by ATEX, IECEx, and cULus Ex Div 1.



**Universal intrinsically safe input**

The ACT20X-HUI-SAO-LP isolates and converts intrinsically safe signals such as  $\pm 25$  mA,  $\pm 28$  V, potentiometer up to 500 k $\Omega$ , resistance up to 12 k $\Omega$ , RTD signals and thermocouple signals.

**For hazardous areas up to zone 0**

Due to the Ex II 1 G Ex ia II C T4...T6 Ga and Ex II 1D Ex ia III T135 °C...T85 °C Da approvals, the VARITECTOR SPC EX surge protection component can be installed directly in zones 0, 1 or 2 in order to protect signals.

**Configuration via FDT/DTM**

The new ACT20X module can be quickly and comfortably configured with vendor neutral FDT/DTM software such as the WI-Manager software. The software also offers monitoring and diagnostic options.

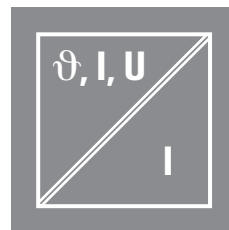

## VARITECTOR SPC EX

## VSPC 1CL EX - protection for one analogue signal in intrinsically safe circuits

- For use in zones 2, 1, and 0
- Pluggable arrester (impedance-neutral plugging/unplugging without interruption)
- Can be tested with the V-TEST testing device
- Version with floating-earth PE connection for avoiding voltage potential differences
- Can be used in accordance with installation standard IEC 62305 as well as in ATEX applications
- Tested in accordance with IEC 61643-21:08 D1,C1,C2,C3
- Integrated PE foot, safely discharges up to 20 kA (8/20  $\mu$ s) and 2.5 kA (10/350  $\mu$ s) to PE

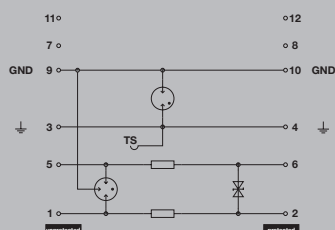

Complete module, indirect earthing

## Technical data

Dielectric strength at FG against PE	$\geq 500$ V
Volume resistance	2.20 $\Omega$
Overload - failure mode	Modus 2
Requirements category acc. to IEC 61643-21	C1, C2, C3, D1
Surge current-carrying capacity C1	< 1 kA 8/20 $\mu$ s
Surge current-carrying capacity C2	5 kA 8/20 $\mu$ s
Surge current-carrying capacity C3	100 A 10/1000 $\mu$ s
Surge current-carrying capacity D1	1 kA 10/350 $\mu$ s
Discharge current $I_t$ (8/20 $\mu$ s) wire-wire/wire-PE/GND-PE	2.5 kA / 2.5 kA / 2.5 kA
Discharge $I_{max}$ (8/20 $\mu$ s) wire-wire/wire-PE/GND-PE	10 kA / 10 kA / 10 kA
Lightning test $I_{imp}$ (10/350 $\mu$ s) wire-wire/wire-PE/GND-PE	2.5 kA / 2.5 kA / 2.5 kA
Type of connection	Pluggable in VSPC BASE
Storage temperature	-40 °C...+80 °C
Ambient temperature (operational)	-40 °C...+70 °C
Protection degree	IP 20
UL 94 flammability rating	V-0
Temperature class T6/85 °C (-40 °C ... +60°C) li	250 mA
Temperature class T5/100°C (-40 °C ... +75°C) li	250 mA
Temperature class T4/135°C (-40°C ... +85°C) li	350 mA
<b>Failure probability</b>	
Ages	45
MTTF	2537
SIL in compliance with IEC 61508	3
<b>Approvals</b>	
Approvals	CE; IECEXDEK; KEMAATEX; TUEV; ROHS
Standards	IEC 61643-21, IEC 62305, DIN EN 60079-0:2009, DIN EN 60079-11:2007, DIN EN 60079-26:2007, DIN EN 61241-11:2006
ATEX - dust labelling	II 1 D Ex ia IIC T135 °C ...T85 °C Da
ATEX - gas labelling	II 1 G Ex ia IIC T4... T6 Ga
IECEX - dust labelling	II 1 D Ex ia IIC T135 °C ...T85 °C Da
IECEX - gas labelling	II 1 G Ex ia IIC T4... T6 Ga

## Dimensions

Height x width x depth	mm	90 / 17.8 / 69
------------------------	----	----------------

## Note

The associated VSPC base element should be ordered with this. The dimension information provided refers to the complete module.

## Base elements / base to arresters



## Ordering data for base

Description	Type	Qty.	Order No.
EX base element, indirect earthing / floating earth FG	VSPC BASE 1CL FG EX	1	8951810000

## Note

Technical data can be found at the end of VARITECTOR SPC EX.

VSPC 1CL EX - plug-in components / arrester



Pluggable component / Arrester



Base element / Base

Ordering data

	VSPC 1CL 5 V DC EX	VSPC 1CL 12 V DC EX	VSPC 1CL 24 V DC EX
Rated voltage (AC)			
Rated voltage (DC)	5 V	12 V	24 V
Rated current	350 mA	350 mA	350 mA
Optical function display	No	No	No
Input attenuation	730 KHz	1.7 MHz	2.4 MHz
Pulse-reset capacity	20 ms	20 ms	30 ms
Residual voltage, $U_r$ typical	800 V	800 V	800 V
<b>EX protection data</b>			
Input voltage, max. $U_i$	6 V	14 V	26 V
Internal capacitance, max. $C_i$	< 4 nF	< 4 nF	< 4 nF
Internal inductance, max. $L_i$	0 $\mu$ H	0 $\mu$ H	0 $\mu$ H
Input power, max. $P_i$	3 W	3 W	3 W
<b>Protection level</b>			
Wire-wire 1 kV/ $\mu$ s, typically	12 V	25 V	45 V
Wire-wire 8/20 $\mu$ s, typically	12 V	25 V	45 V
Wire-PE 1kV/ $\mu$ s, typically	450 V	450 V	450 V
Wire-PE 8/20 $\mu$ s, typically	650 V	650 V	650 V

Ordering data	VSPC 1CL 5VDC EX	VSPC 1CL 12VDC EX	VSPC 1CL 24VDC EX
Type	VSPC 1CL 5VDC EX	VSPC 1CL 12VDC EX	VSPC 1CL 24VDC EX
Order No.	<b>8953660000</b>	<b>8953690000</b>	<b>8953600000</b>
Qty.	1 ST	1 ST	1 ST
<b>Note</b>			



## VARITECTOR SPC EX

## VSPC 2CL EX – protection for two analogue signals in intrinsically safe circuits

- For use in zones 2, 1, and 0
- Pluggable arrester (impedance-neutral plugging/unplugging without interruption)
- Can be tested with the V-TEST testing device
- Space-saving design for 3 analogue signals
- Version with floating-earth PE connection for avoiding voltage potential differences
- Usable in accordance with installations standard IEC 62305
- Tested in accordance with IEC 61643-21:08 D1,C1,C2,C3
- Integrated PE foot, safely discharges up to 20 kA (8/20  $\mu$ s) and 2.5 kA (10/350  $\mu$ s) to PE

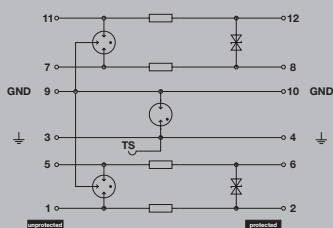

Complete module, indirect earthing

## Technical data

Dielectric strength at FG against PE	$\geq 500$ V
Volume resistance	2.20 $\Omega$
Overload - failure mode	Modus 2
Requirements category acc. to IEC 61643-21	C1, C2, C3, D1
Surge current-carrying capacity C1	< 1 kA 8/20 $\mu$ s
Surge current-carrying capacity C2	5 kA 8/20 $\mu$ s
Surge current-carrying capacity C3	100 A 10/1000 $\mu$ s
Surge current-carrying capacity D1	1 kA 10/350 $\mu$ s
Discharge current $I_t$ (8/20 $\mu$ s) wire-wire/wire-PE/GND-PE	2.5 kA / 2.5 kA / 2.5 kA
Discharge $I_{max}$ (8/20 $\mu$ s) wire-wire/wire-PE/GND-PE	10 kA / 2 x 10 kA / 10 kA
Lightning test $I_{imp}$ (10/350 $\mu$ s) wire-wire/wire-PE/GND-PE	2.5 kA / 2.5 kA / 2.5 kA
Type of connection	Pluggable in VSPC BASE
Storage temperature	-40 °C...+80 °C
Ambient temperature (operational)	-40 °C...+70 °C
Protection degree	IP 20
UL 94 flammability rating	V-0
Temperature class T6/85 °C (-40 °C ... +60°C) li	250 mA
Temperature class T5/100°C (-40 °C ... +75°C) li	250 mA
Temperature class T4/135°C (-40°C ... +85°C) li	350 mA
<b>Failure probability</b>	
Ages	45
MTTF	2537
SIL in compliance with IEC 61508	3
<b>Approvals</b>	
Approvals	CE; IECEXDEK; KEMAATEX; TUEV; ROHS
Standards	IEC 61643-21, IEC 62305, DIN EN 60079-0:2009, DIN EN 60079-11:2007, DIN EN 60079-26:2007, DIN EN 61241-11:2006
ATEX - dust labelling	II 1 D Ex ia IIC T135 °C ...T85 °C Da
ATEX - gas labelling	II 1 G Ex ia IIC T4... T6 Ga
IECEX - dust labelling	II 1 D Ex ia IIC T135 °C ...T85 °C Da
IECEX - gas labelling	II 1 G Ex ia IIC T4... T6 Ga

## Dimensions

Height x width x depth	mm	90 / 17.8 / 69
------------------------	----	----------------

## Note

The associated VSPC base element should be ordered with this. The dimension information provided refers to the complete module.

## Base elements / base to arresters



## Ordering data for base

Description	Type	Qty.	Order No.
EX base element, indirect earthing / floating earth FG	VSPC BASE 2CL FG EX	1	8951820000

## Note

Technical data can be found at the end of VARITECTOR SPC EX.

VSPC 2CL EX - plug-in components / arrester



Pluggable component / Arrester



Base element / Base

Ordering data

VSPC 2CL 24 V DC EX

Rated voltage (AC)	
Rated voltage (DC)	24 V
Rated current	250 mA
Optical function display	No
Input attenuation	2.3 MHz
Pulse-reset capacity	30 ms
Residual voltage, $U_r$ , typical	800 V
<b>EX protection data</b>	
Input voltage, max. $U_i$	26 V
Internal capacitance, max. $C_i$	< 4 nF
Internal inductance, max. $L_i$	0 $\mu$ H
Input power, max. $P_i$	3 W
<b>Protection level</b>	
Wire-wire 1 kV/ $\mu$ s, typically	45 V
Wire-wire 8/20 $\mu$ s, typically	45 V
Wire-PE 1kV/ $\mu$ s, typically	450 V
Wire-PE 8/20 $\mu$ s, typically	800 V

Ordering data

Type	VSPC 2CL 24VDC EX
Order No.	<b>8953720000</b>
Qty.	1 ST

Note



## VARITECTOR SPC EX

## VSPC 1CL PW EX - combinations in current loop signal and device protection in intrinsically safe circuits

- Pluggable arrester (impedance-neutral plugging/unplugging without interruption)
- Can be tested with the V-TEST testing device
- Version with floating-earth PE connection for avoiding voltage potential differences
- Usable in accordance with installations standard IEC 62305
- Tested in accordance with IEC 61643-21:08 D1,C1,C2,C3
- For use in zones 2, 1, and 0
- Tested in accordance with IEC 61643-11:09 Class III
- Integrated PE foot, safely discharges up to 20 kA (8/20  $\mu$ s) and 2.5 kA (10/350  $\mu$ s) to PE



## Technical data

Rated voltage (DC)	24 V
Max. continuous voltage, $U_c$ (DC)	28 V
Dielectric strength at FG against PE	$\geq 500$ V
Volume resistance	2.20 $\Omega$
Overload - failure mode	Modus 2
Requirements category acc. to IEC 61643-21	C1, C2, C3, D1
Rated voltage (AC/DC)	
Surge current-carrying capacity C1	< 1 kA 8/20 $\mu$ s
Surge current-carrying capacity C2	5 kA 8/20 $\mu$ s
Surge current-carrying capacity C3	100 A 10/1000 $\mu$ s
Surge current-carrying capacity D1	2.5 kA 10/350 $\mu$ s
Input attenuation	3 MHz
Pulse-reset capacity	$\leq 10$ ms
Discharge current $I_t$ (8/20 $\mu$ s) wire-wire/wire-PE/GND-PE	2.5 kA / 2.5 kA / 2.5 kA
Discharge $I_{max}$ (8/20 $\mu$ s) wire-wire/wire-PE/GND-PE	10 kA / 10 kA / 10 kA
Lightning test $I_{mp}$ (10/350 $\mu$ s) wire-wire/wire-PE/GND-PE	2.5 kA / 2.5 kA / 2.5 kA
Residual voltage, $U_r$ typical	800 V
Wire-PE 1kV/ $\mu$ s, typically	450 V
Wire-PE 8/20 $\mu$ s, typically	650 V
Wire-wire 1 kV/ $\mu$ s, typically	60 V
Wire-wire 8/20 $\mu$ s, typically	60 V
Standards	IEC 61643-21, IEC 62305, DIN EN 60079-0:2009, DIN EN 60079-11:2007, DIN EN 60079-26:2007, DIN EN 61241-11:2006

## Power protection class III

Rated voltage (DC)	24 V
Max. continuous voltage, $U_c$ (DC)	28 V
Combined pulse $U_{oc}$	6 kV
Residual voltage, $U_r$ typical	800 V
Rated current	350 mA
Input voltage, max. $U_i$	20 V

## Dimensions

Height x width x depth	mm	90 / 17.8 / 69
------------------------	----	----------------

## Note

The associated VSPC base element should be ordered with this. The dimension information provided refers to the complete module.

## Ordering data for base

Description	Type	Qty.	Order No.
EX base element, indirect earthing / floating earth FG	VSPC BASE 1CL PW FG EX	1	1070470000

## Note

Technical data can be found at the end of VARITECTOR SPC EX.

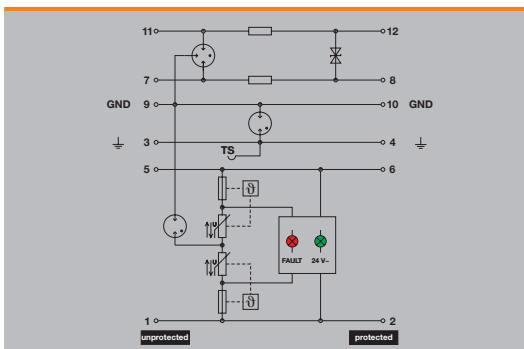

Complete module, indirect earthing

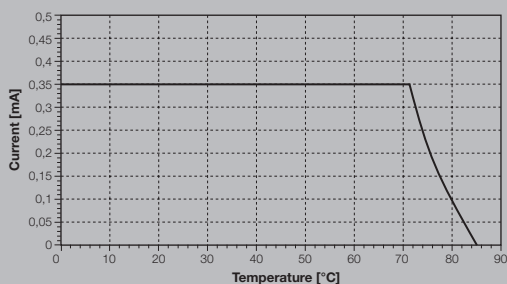

## Base elements / base to arresters



VSPC 1CL PW EX - plug-in components / arrester



Pluggable component / Arrester



Base element / Base

Ordering data

Rated voltage (AC)  
 Rated voltage (DC)  
 Rated current  
 Optical function display  
 Input attenuation  
 Pulse-reset capacity  
 Residual voltage,  $U_r$ , typical

VSPC 1CL PW 24 V EX	
Rated voltage (AC)	34 V
Rated voltage (DC)	24 V
Rated current	350 mA
Optical function display	For Class III protection, green = OK; red = arrester is defective - replace
Input attenuation	3 MHz
Pulse-reset capacity	$\leq 10$ ms
Residual voltage, $U_r$ , typical	800 V

EX protection data

Input voltage, max.  $U_i$   
 Internal capacitance, max.  $C_i$   
 Internal inductance, max.  $L_i$   
 Input power, max.  $P_i$

Input voltage, max. $U_i$	20 V
Internal capacitance, max. $C_i$	$< 4$ nF
Internal inductance, max. $L_i$	0 $\mu$ H
Input power, max. $P_i$	3 W

Protection level

Wire-wire 1 kV/ $\mu$ s, typically  
 Wire-wire 8/20  $\mu$ s, typically  
 Wire-PE 1kV/ $\mu$ s, typically  
 Wire-PE 8/20  $\mu$ s, typically

Wire-wire 1 kV/ $\mu$ s, typically	60 V
Wire-wire 8/20 $\mu$ s, typically	60 V
Wire-PE 1kV/ $\mu$ s, typically	450 V
Wire-PE 8/20 $\mu$ s, typically	650 V

Ordering data

Type  
 Order No.  
 Qty.

Type	VSPC 1CL PW 24V EX
Order No.	<b>8953610000</b>
Qty.	1 ST

Note



## VARITECTOR SPC EX

## VSPC 2SL EX – protection for two binary signals in intrinsically safe circuits

- For use in zones 2, 1, and 0
- Pluggable arrester (impedance-neutral plugging/unplugging without interruption)
- Can be tested with the V-TEST testing device
- Version with floating-earth PE connection for avoiding voltage potential differences
- Can be used in accordance with installation standard IEC 62305 as well as in ATEX applications
- Tested in accordance with IEC 61643-21:08 D1,C1,C2,C3
- Integrated PE foot, safely discharges up to 20 kA (8/20  $\mu$ s) and 2.5 kA (10/350  $\mu$ s) to PE

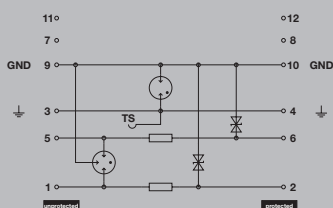

Complete module, indirect earthing

## Technical data

Dielectric strength at FG against PE	$\geq 500$ V
Volume resistance	4.7 $\Omega$
Overload - failure mode	Modus 2
Requirements category acc. to IEC 61643-21	C1, C2, C3, D1
Surge current-carrying capacity C1	< 1 kA 8/20 $\mu$ s
Surge current-carrying capacity C2	5 kA 8/20 $\mu$ s
Surge current-carrying capacity C3	100 A 10/1000 $\mu$ s
Surge current-carrying capacity D1	2.5 kA 10/350 $\mu$ s
Discharge current $I_t$ (8/20 $\mu$ s) wire-wire/wire-PE/GND-PE	2.5 kA / 2.5 kA / 2.5 kA
Discharge $I_{max}$ (8/20 $\mu$ s) wire-wire/wire-PE/GND-PE	10 kA / 10 kA / 10 kA
Lightning test $I_{imp}$ (10/350 $\mu$ s) wire-wire/wire-PE/GND-PE	2.5 kA / 2.5 kA / 2.5 kA
Type of connection	Pluggable in VSPC BASE
Storage temperature	-40 °C...+80 °C
Ambient temperature (operational)	-40 °C...+70 °C
Protection degree	IP 20
UL 94 flammability rating	V-0
Temperature class T6/85 °C (-40 °C ... +60°C) li	250 mA
Temperature class T5/100°C (-40 °C ... +75°C) li	250 mA
Temperature class T4/135°C (-40°C ... +85°C) li	350 mA
<b>Failure probability</b>	
Ages	43
MTTF	2665
SIL in compliance with IEC 61508	2
<b>Approvals</b>	
Approvals	CE; IECEXDEK; KEMAATEX; TUEV; ROHS
Standards	IEC 61643-21, IEC 62305, DIN EN 60079-0:2009, DIN EN 60079-11:2007, DIN EN 60079-26:2007, DIN EN 61241-11:2006
ATEX - dust labelling	II 1 D Ex ia IIC T135 °C ...T85 °C Da
ATEX - gas labelling	II 1 G Ex ia IIC T4... T6 Ga
IECEX - dust labelling	II 1 D Ex ia IIC T135 °C ...T85 °C Da
IECEX - gas labelling	II 1 G Ex ia IIC T4... T6 Ga

## Dimensions

Height x width x depth	mm	90 / 17.8 / 69
------------------------	----	----------------

## Note

Order the associated VSPC base element with this. The dimension information provided refers to the complete module.

## Base elements / base to arresters



## Ordering data for base

Description	Type	Qty.	Order No.
EX base element, indirect earthing / floating earth FG	VSPC BASE 2SL FG EX	1	8951830000

## Note

Technical data can be found at the end of VARITECTOR SPC EX.

VSPC 2SL EX - plug-in components / arrester



Pluggable component / Arrester



Base element / Base

Ordering data

	VSPC 2SL 12 V DC EX	VSPC 2SL 12 V AC EX	VSPC 2SL 24 V DC EX	VSPC 2SL 48 V AC EX
Rated voltage (AC)		12 V		48 V
Rated voltage (DC)	12 V	16 V	24 V	68 V
Rated current	250 mA	250 mA	250 mA	250 mA
Optical function display	No	No	No	No
Input attenuation	1.2 MHz	2.5 MHz	2.7 MHz	2.7 MHz
Pulse-reset capacity	20 ms	20 ms	30 ms	60 ms
Residual voltage, $U_r$ , typical	25 V	50 V	50 V	60 V
<b>EX protection data</b>				
Input voltage, max. $U_i$	14 V	19 V	26 V	75 V
Internal capacitance, max. $C_i$	< 4 nF	< 4 nF	< 4 nF	< 4 nF
Internal inductance, max. $L_i$	0 $\mu$ H	0 $\mu$ H	0 $\mu$ H	0 $\mu$ H
Input power, max. $P_i$	3 W	3 W	3 W	3 W
<b>Protection level</b>				
Wire-wire 1 kV/ $\mu$ s, typically	20 V	20 V	40 V	80 V
Wire-wire 8/20 $\mu$ s, typically	45 V	55 V	75 V	80 V
Wire-PE 1 kV/ $\mu$ s, typically	25 V	30 V	40 V	85 V
Wire-PE 8/20 $\mu$ s, typically	50 V	50 V	60 V	125 V
<b>Ordering data</b>				
Type	VSPC 2SL 12VDC EX	VSPC 2SL 12VAC EX	VSPC 2SL 24VDC EX	VSPC 2SL 48VAC EX
Order No.	<b>8953620000</b>	<b>8953630000</b>	<b>8953670000</b>	<b>8953640000</b>
Qty.	1 ST	1 ST	1 ST	1 ST
<b>Note</b>				



## VARITECTOR SPC EX

## VSPC 4SL EX - protection for four binary signals in intrinsically safe circuits

- For use in zones 2, 1, and 0
- Pluggable arrester (impedance-neutral plugging/unplugging without interruption)
- Can be tested with the V-TEST testing device
- Version with floating-earth PE connection for avoiding voltage potential differences
- Usable in accordance with installations standard IEC 62305
- Tested in accordance with IEC 61643-21:08 D1,C1,C2,C3
- Integrated PE foot, safely discharges up to 20 kA (8/20  $\mu$ s) and 2.5 kA (10/350  $\mu$ s) to PE

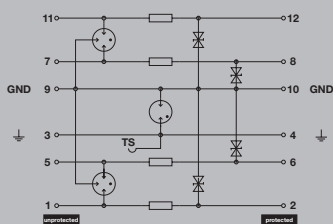

Complete module, indirect earthing

## Technical data

Dielectric strength at FG against PE	$\geq 500$ V
Volume resistance	4.7 $\Omega$
Overload - failure mode	Modus 2
Requirements category acc. to IEC 61643-21	C1, C2, C3, D1
Surge current-carrying capacity C1	< 1 kA 8/20 $\mu$ s
Surge current-carrying capacity C2	5 kA 8/20 $\mu$ s
Surge current-carrying capacity C3	100 A 10/1000 $\mu$ s
Surge current-carrying capacity D1	2.5 kA 10/350 $\mu$ s
Discharge current $I_t$ (8/20 $\mu$ s) wire-wire/wire-PE/GND-PE	2.5 kA / 2.5 kA / 2.5 kA
Discharge $I_{max}$ (8/20 $\mu$ s) wire-wire/wire-PE/GND-PE	10 kA / 10 kA / 10 kA
Lightning test $I_{imp}$ (10/350 $\mu$ s) wire-wire/wire-PE/GND-PE	2.5 kA / 2.5 kA / 2.5 kA
Type of connection	Pluggable in VSPC BASE
Storage temperature	-40 °C...+80 °C
Ambient temperature (operational)	-40 °C...+70 °C
Protection degree	IP 20
UL 94 flammability rating	V-0
Temperature class T6/85 °C (-40 °C ... +60°C) li	250 mA
Temperature class T5/100°C (-40 °C ... +75°C) li	250 mA
Temperature class T4/135°C (-40°C ... +85°C) li	350 mA
<b>Failure probability</b>	
Ages	43
MTTF	2665
SIL in compliance with IEC 61508	2
<b>Approvals</b>	
Approvals	CE; IECEXDEK; KEMAATEX; ROHS
Standards	IEC 61643-21, IEC 62305, DIN EN 60079-0:2009, DIN EN 60079-11:2007, DIN EN 60079-26:2007, DIN EN 61241-11:2006
ATEX - dust labelling	II 1 D Ex ia IIC T135 °C ...T85 °C Da
ATEX - gas labelling	II 1 G Ex ia IIC T4... T6 Ga
IECEX - dust labelling	II 1 D Ex ia IIC T135 °C ...T85 °C Da
IECEX - gas labelling	II 1 G Ex ia IIC T4... T6 Ga

## Dimensions

Height x width x depth	mm	90 / 17.8 / 69
------------------------	----	----------------

## Note

The associated VSPC base element should be ordered with this. The dimension information provided refers to the complete module.

## Base elements / base to arresters



## Ordering data for base

Description	Type	Qty.	Order No.
EX base element, indirect earthing / floating earth FG	VSPC BASE 4SL FG EX	1	8951840000

## Note

Technical data can be found at the end of VARITECTOR SPC EX.

VSPC 4SL EX - plug-in components / arrester



Pluggable component / Arrester



Base element / Base

Ordering data

	VSPC 4SL 12 V DC EX	VSPC 4SL 12 V AC EX	VSPC 4SL 24 V DC EX	VSPC 4SL 24 V AC EX
Rated voltage (AC)		12 V		24 V
Rated voltage (DC)	12 V	16 V	24 V	34 V
Rated current	300 mA	300 mA	300 mA	300 mA
Optical function display	No	No	No	No
Input attenuation	1.2 MHz	2.5 MHz	4 MHz	2.7 MHz
Pulse-reset capacity	20 ms	20 ms	30 ms	30 ms
Residual voltage, $U_r$ , typical	25 V	35 V	60 V	60 V
<b>EX protection data</b>				
Input voltage, max. $U_i$	14 V	19 V	26 V	38 V
Internal capacitance, max. $C_i$	< 4 nF	< 4 nF	< 4 nF	< 4 nF
Internal inductance, max. $L_i$	0 $\mu$ H	0 $\mu$ H	0 $\mu$ H	0 $\mu$ H
Input power, max. $P_i$	3 W	3 W	3 W	3 W
<b>Protection level</b>				
Wire-wire 1 kV/ $\mu$ s, typically	45 V	55 V	80 V	110 V
Wire-wire 8/20 $\mu$ s, typically	45 V	55 V	80 V	80 V
Wire-PE 1 kV/ $\mu$ s, typically	25 V	30 V	40 V	60 V
Wire-PE 8/20 $\mu$ s, typically	50 V	50 V	60 V	60 V

Ordering data

	VSPC 4SL 12VDC EX	VSPC 4SL 12VAC EX	VSPC 4SL 24VDC EX	VSPC 4SL 24VAC EX
Type	VSPC 4SL 12VDC EX	VSPC 4SL 12VAC EX	VSPC 4SL 24VDC EX	VSPC 4SL 24VAC EX
Order No.	<b>1161170000</b>	<b>1161150000</b>	<b>1161190000</b>	<b>1161180000</b>
Qty.	1 ST	1 ST	1 ST	1 ST
<b>Note</b>				



## VARITECTOR SPC EX

## VSPC 3/4 SL WIRE EX - protection for 3/4-wire signals in intrinsically safe areas

- Protection of measuring bridge signals in zones 2, 1 and 0
- Pluggable arrester (impedance-neutral plugging/unplugging without interruption)
- Can be tested with the V-TEST testing device
- Version with floating-earth PE connection for avoiding voltage potential differences
- Can be used in accordance with installation standard IEC 62305 and in ATEX applications
- Tested in accordance with IEC 61643-21:08 D1, C1, C2, C3
- Integrated PE foot, safely discharges up to 20 kA (8/20  $\mu$ s) and 2.5 kA (10/350  $\mu$ s) to PE



## Technical data

Dielectric strength at FG against PE	$\geq 500$ V
Volume resistance	0.20 $\Omega$
Overload - failure mode	Modus 2
Requirements category acc. to IEC 61643-21	C1, C2, C3, D1
Surge current-carrying capacity C1	< 1 kA 8/20 $\mu$ s
Surge current-carrying capacity C2	5 kA 8/20 $\mu$ s
Surge current-carrying capacity C3	100 A 10/1000 $\mu$ s
Surge current-carrying capacity D1	2.5 kA 10/350 $\mu$ s
Discharge current $I_t$ (8/20 $\mu$ s) wire-wire/wire-PE/GND-PE	2.5 kA / 2.5 kA / 2.5 kA
Discharge $I_{max}$ (8/20 $\mu$ s) wire-wire/wire-PE/GND-PE	10 kA / 10 kA / 10 kA
Lightning test $I_{imp}$ (10/350 $\mu$ s) wire-wire/wire-PE/GND-PE	2.5 kA / 2.5 kA / 2.5 kA
Type of connection	Pluggable in VSPC BASE
Storage temperature	-40 °C...+80 °C
Ambient temperature (operational)	-40 °C...+70 °C
Protection degree	IP 20
UL 94 flammability rating	V-0
Temperature class T6/85 °C (-40 °C ... +60°C) li	250 mA
Temperature class T5/100°C (-40 °C ... +75°C) li	250 mA
Temperature class T4/135°C (-40°C ... +85°C) li	350 mA
<b>Failure probability</b>	
Ages	43
MTTF	2655
SIL in compliance with IEC 61508	3
<b>Approvals</b>	
Approvals	CE; IECEXDEK; KEMAATEX; TUEV; ROHS
Standards	IEC 61643-21, IEC 62305, DIN EN 60079-0:2009, DIN EN 60079-11:2007, DIN EN 60079-26:2007, DIN EN 61241-11:2006
ATEX - dust labelling	II 1 D Ex ia IIC T135 °C ...T85 °C Da
ATEX - gas labelling	II 1 G Ex ia IIC T4... T6 Ga
IECEX - dust labelling	II 1 D Ex ia IIC T135 °C ...T85 °C Da
IECEX - gas labelling	II 1 G Ex ia IIC T4... T6 Ga

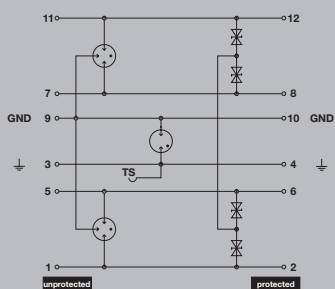

Complete module, indirect earthing

## Dimensions

Height x width x depth	mm	90 / 17.8 / 69
------------------------	----	----------------

## Note

The associated VSPC base element should be ordered with this. The dimension information provided refers to the complete module.

## Base elements / base to arresters



## Ordering data for base

Description	Type	Qty.	Order No.
EX base element, indirect earthing / floating earth FG	VSPC BASE 4SL FG EX	1	8951840000

## Note

Technical data can be found at the end of VARITECTOR SPC EX.

VSPC 3/4SL WIRE EX- plug-in components / arrester



Pluggable component / Arrester



Base element / Base

Ordering data

Rated voltage (AC)  
 Rated voltage (DC)  
 Rated current  
 Optical function display  
 Capacitance  
 Pulse-reset capacity  
 Residual voltage,  $U_r$ , typical

VSPC 3/4 WIRE 5 V DC EX

24 V  
 300 mA  
 No  
 2.3 pF  
 20 ms  
 800 V

EX protection data

Input voltage, max.  $U_i$   
 Internal capacitance, max.  $C_i$   
 Internal inductance, max.  $L_i$   
 Input power, max.  $P_i$

6 V  
 < 4 nF  
 0  $\mu$ H  
 3 W

Protection level

Wire-wire 1 kV/ $\mu$ s, typically  
 Wire-wire 8/20  $\mu$ s, typically  
 Wire-PE 1kV/ $\mu$ s, typically  
 Wire-PE 8/20  $\mu$ s, typically

35 V  
 35 V  
 250 V  
 800 V

Ordering data

Type  
 Order No.  
 Qty.

VSPC 3/4WIRE 5VDC EX  
**8953650000**  
 1 ST

Note



## VARITECTOR SPC EX

### Indirect earthing

Base element, indirect earthing via spark gap FG, floating earth for ATEX applications.

### EX base element with FG

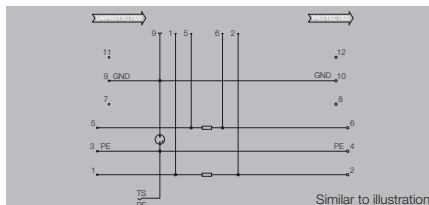

### Technical data

Stripping length, rated connection  
 Wire cross-section, stranded, min.  
 Wire cross-section, stranded, max.  
 Wire cross-section, solid, min.  
 Wire cross-section, solid, max.  
 Clamping range, rated connection, min.  
 Clamping range, rated connection, max.  
 Tightening torque, min.  
 Tightening torque, max.  
 Type of connection  
 Certificate No. (UL)  
 Approvals  
 Ambient temperature (operational)  
 Storage temperature  
 UL 94 flammability rating  
 Pollution severity  
 Surge voltage category

7 mm
0.5 mm <sup>2</sup>
2.5 mm <sup>2</sup>
0.5 mm <sup>2</sup>
4 mm <sup>2</sup>
0.5 mm <sup>2</sup>
4 mm <sup>2</sup>
0.5 Nm
0.8 Nm
Screw connection
CE; IEC EX DEK; KEMA ATEX; ROHS
-40 °C...+70 °C
-40 °C...+80 °C
V-0
2
III

<b>Dimensions</b>	
Height x width	mm

90 / 17.8
-----------

<b>Note</b>
-------------

### Ordering data

No remote sig. contact

Type	Qty.	Order No.
VSPC BASE 4SL FG EX	1	895 1840000
VSPC BASE 2SL FG EX	1	895 1830000
VSPC BASE 2CL FG EX	1	895 1820000
VSPC BASE 1CL FG EX	1	895 1810000
VSPC BASE 1CL PW FG EX	1	1070470000

<b>Note</b>
-------------

Technical data can be found at the end of VARITECTOR SPC EX.

### Accessories

<b>Note</b>
-------------

EMC Set: 1067470000 Marker: DEK 5

B



# VARITECTOR SSC EX



## VARITECTOR SSC EX

### 12.4-mm-wide lightning and surge protection for measurement and control signals in the Ex zone

When used in intrinsically safe circuits within Ex zones 2 to 0, the VARITECTOR SSC can reliably protect measurement and control signals from lightning and surge voltages. Lightning and surge voltages – coupled from the field side to machines and facilities – can cause signal interference or even destroy connected devices. They could even lead to an explosion within high-risk Ex-zone applications. The new VARITECTOR SSC EX product line, with a width of 12.4 mm, offers protection against these risks. These products comply with the new IEC 61643-21:2008 standard. They fulfil the “over-stress mode” described. They also meet the latest ATEX standards, EN 60079. These lightning and surge components are a versatile and efficient solution because they feature a direct PE contact, extensive labelling and diagnostic options, and easy separation of the signal paths. The VARITECTOR SSC EX takes advantage of these features so that it can easily be used in place of a transfer terminal.

### Labelling of the VSSC EX equipment

#### ATEX:

For gas  
II 1 G Ex ia IIC T4...T6  
For dust  
II 1 D Ex ia IIIC T135 °C...T85 °C  
DEKRA 11ATEX0023X

#### IEX EX:

For gas  
Ex ia IIC T4...T6 Ga  
For dust  
Ex ia IIIC T135 °C...T85 °C Da

Basic health and safety functions are fulfilled through compliance with: IEC 61643-21, EN 60079-0, EN 60079-1, EN 60079-26, EN 61241-11;

The VSSC series comes in a light blue housing and is used to protect electronics connected to intrinsically safe circuits. The VSSC has a negligible internal inductance and capacitance.

### Products for intrinsically safe circuits

**VSSC4 CL FG EX** are used to protect an intrinsically safe current loop.

**VSSC4 SL FG EX** are used to protect intrinsically safe **binary signal circuits** (such as alarm contacts).

**VSSC4 GDT 24Vuc 20kA EX** can be used to provide high-resistance earthing for shields

**VSSC6 TR CL 24Vuc EX** are used to protect an intrinsically safe current loop. Measurements can be taken in the current loop by simply opening the isolator. A test plug can be inserted in the 2.3-mm test socket (built into the head of the Torx® screws).

**VSSC6 RS485 PA EX** is used to protect the intrinsically safe PROFIBUS-DP.

## General technical data

Storage temperature: -40 °C...+80 °C  
Operating temperature: -40 °C...70 °C  
Humidity: 5 %...96 % RH without condensation

Material: V0, IP 20  
Connection: VSSC4 and VSSC6  
Torx® T15 900917  
Slotted: 0.8 x 4 900834  
Nominal torque: 0.5 Nm  
Max. torque: 1 Nm  
Stripping length: 10 mm  
Solid core: 0.5...6 mm<sup>2</sup>  
Finely stranded: 0.5...4 mm<sup>2</sup>  
Finely stranded with ferrule: 0.5...4 mm<sup>2</sup>

## Dimensions

### VSSC4:

Width with frame: 12.4 mm  
Height: 76 mm  
Depth: 58.5 mm with TS 35 x 7.5  
Top connections:  
Unprotected: 1  
Protected: 4  
Bottom connections:  
Unprotected: 2  
Protected: 3

### VSSC6:

Width with frame: 12,4 mm  
Height: 88,5 mm  
Depth: 81 mm mit TS 35 x 7,5  
Top connections:  
Unprotected: 1  
Protected: 4  
Mid-level connections:  
Unprotected: 2  
Protected: 5  
Bottom connections:  
Unprotected: 3  
Protected: 6

## Markers for VSSC4 and VSSC6:

Dekafix: DEK6 for the connections  
WS10/6 middle for the device markers  
SNAPMARK only for the VSSC6



# VARITECTOR SSC EX



## Lightning and surge protection for intrinsically safe circuits in the explosion hazard area

When used in intrinsically safe circuits within EX zones 2 to 0, the VARITECTOR SSC can reliably protect measurement and control signals from lightning and surge voltages.

Lightning and surge voltages – whether direct at the facilities, near field or far field – can cause signal interference or even destroy connected devices. They could even lead to an explosion within hazardous areas applications. The VARITECTOR SSC EX product line, with a width of 12.4 mm, offers protection against these risks. These products comply with the new IEC 61643-21: 2008 standard. They fulfil the “over-stress mode” described. They are also in compliance with the most current ATEX Standard, in EN 60079. Lightning and surge protection components are versatile and simple to use since they feature direct contact to the PE, many marking and diagnostic options, and an easily disconnected signal path. The VARITECTOR SSC EX takes advantages of these features so that it can easily be used in place of a transfer terminal.

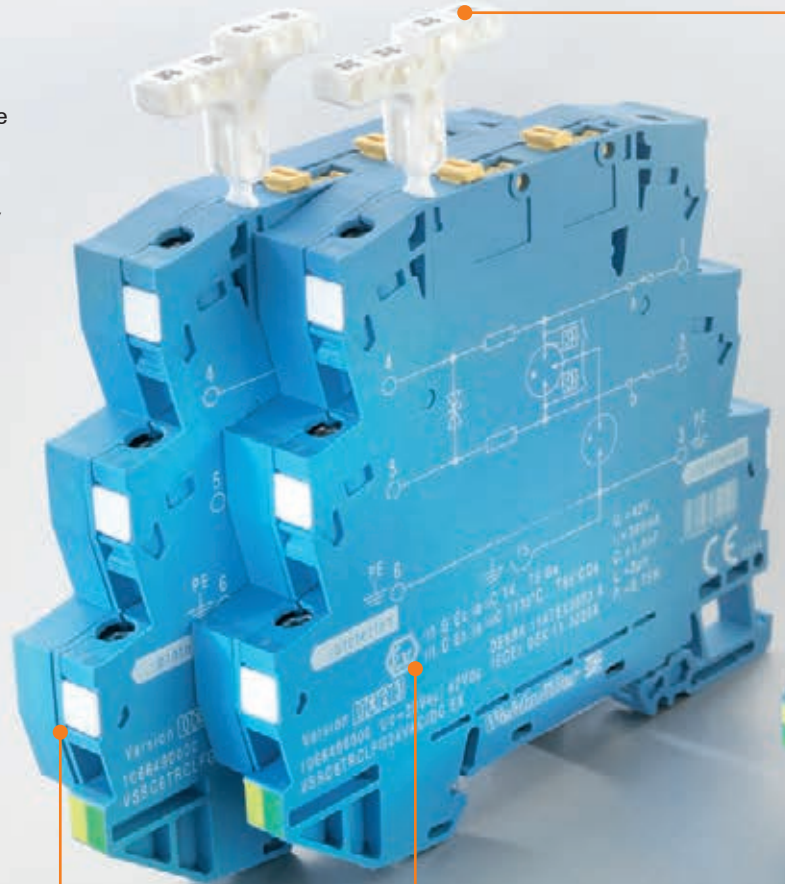

### Space-saving

A compact installation is possible because of the VSSC EX module's terminal design and 12.4 mm alignment width.



### No limitations when used in the EX zone

The EX zone approval provides the proof that the VSSC EX can be used in all EX zones (from zone 2 to zone 0) for dust or gas.



**Fast identification**

Versatile labelling: labels for equipment and individual connections, also easy to read SnapMark markers for any installation position.

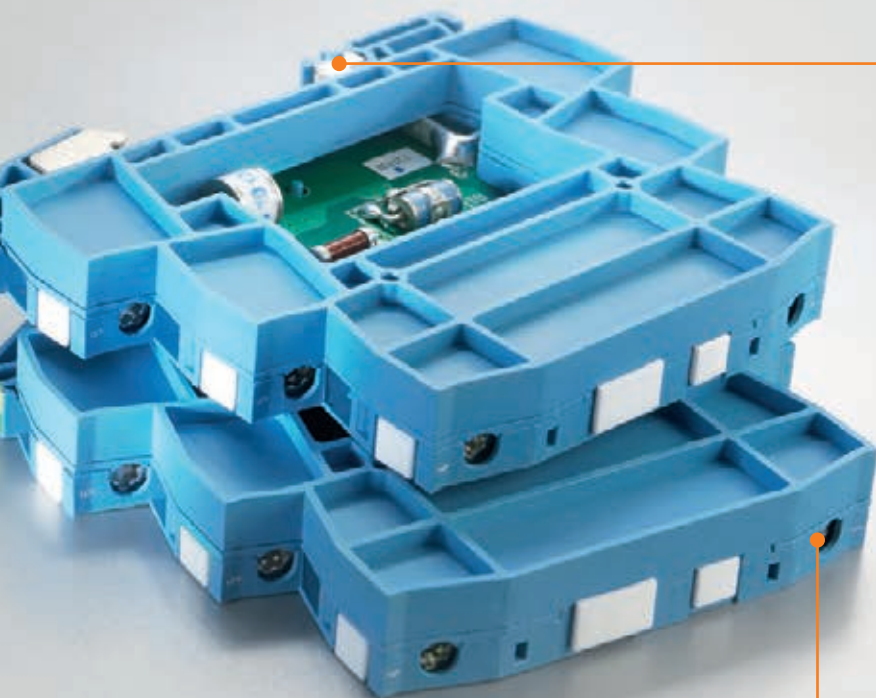
**Complete, standard compliant protection**

The VSSC EX prevents compensation currents in the PE. It also complies with the over stress mode of the IEC 61643-21:2008 standard.

**No proof of intrinsic safety**

Because of the negligible Li and Ci values, no special proof is required for EX zone use.



## VARITECTOR SSC EX

## VSSC 4 CL FG EX - protection for floating earth, intrinsically safe current loops

- 2-stage surge protection. Screw connection for intrinsically safe measurement and control signals
- Terminal block design
- Modular width 12.4 mm
- Space-saving design: 1 analogue signal
- Torx® slotted screw connection
- Version with floating-earth PE connection avoids differences in voltage potential
- Complies with installation standard IEC 62305 and ATEX applications
- Integrated PE foot, safely discharges up to 20 kA (8/20 µs) & 2.5 kA (10/350 µs) to PE



## Technical data

Dielectric strength at FG against PE	≥ 500 V
Volume resistance	1.8 Ω 10 %
Overload - failure mode	Modus 2
Requirements category acc. to IEC 61643-21	C2, C3, D1
Surge current-carrying capacity C1	
Surge current-carrying capacity C2	2.5 kA 8/20 µs 5 kV 1.2/50 µs
Surge current-carrying capacity C3	50 A 10/1000 µs
Surge current-carrying capacity D1	0.5 kA 10/350 µs
Discharge current I <sub>1</sub> (8/20 µs) wire-wire/wire-PE/GND-PE	2.5 kA / 2.5 kA /
Discharge I <sub>max</sub> (8/20 µs) wire-wire/wire-PE/GND-PE	5 kA / 5 kA /
Lightning test I <sub>imp</sub> (10/350 µs) wire-wire/wire-PE/GND-PE	/ 0.5 kA /
Type of connection	Screw connection, Torx® T15, Slotted 0.8 x 4
Storage temperature	-40 °C...+80 °C
Ambient temperature (operational)	-40 °C...+70 °C
Protection degree	IP 20
UL 94 flammability rating	V-0

## Connection data

Type of connection	Screw connection, Torx® T15, Slotted 0.8 x 4
Tightening torque	0.5 Nm
Wire connection cross section, finely stranded, max.	4 mm <sup>2</sup>
Wire connection cross-section, finely stranded, min.	0.5 mm <sup>2</sup>
Wire cross-section, solid, max.	6 mm <sup>2</sup>
Wire cross-section, solid, min.	0.5 mm <sup>2</sup>
Wire cross-section, stranded, max.	4 mm <sup>2</sup>
Wire cross-section, stranded, min.	0.5 mm <sup>2</sup>
Stripping length	10 mm
Mounting rail	TS 35

## Failure probability

ages	
MTTF	
SIL in compliance with IEC 61508	3

## Approvals

Approvals	CE; DEKRAATEX; GOSTME25; IECEXDEK; TUEV; ROHS
Standards	IEC61643-21:2009, DIN EN 60079-0:2009, DIN EN 60079-26:2007, DIN EN 61241-11:2006
ATEX - dust labelling	II 1 D Ex ia IIC T135 °C ...T85 °C Da
ATEX - gas labelling	II 1 G Ex ia IIC T4... T6 Ga
IECEX - dust labelling	II 1 D Ex ia IIC T135 °C ...T85 °C Da
IECEX - gas labelling	II 1 G Ex ia IIC T4... T6 Ga

## Dimensions

Height x width x depth	mm	76 / 12.2 / 58.5
------------------------	----	------------------

## Note

ATEX approval: II 1 G EX ia IIC T4...T6 Ga II 1 D EX ia IIC T135°C...T85°C  
DEKRA No: 11ATEX0023 X

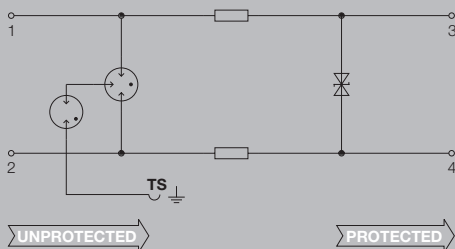

VSSC 4 CL FG EX

Ordering data

Rated voltage (AC)  
Rated voltage (DC)  
Rated current  
Optical function display  
Input attenuation  
Pulse-reset capacity  
Residual voltage,  $U_p$  typical

	VSSC4 CL FG 24 V UC EX	VSSC4 CL FG 48 V UC EX
	24 V	48 V
	34 V	68 V
	300 mA	300 mA
	No	No
	3.4 MHz	5 MHz
	≤ 15 ms	≤ 15 ms
	918 V	773 V
EX protection data		
Input voltage, max. $U_i$	42 V	55 V
Internal capacitance, max. $C_i$	1 nF	1 nF
Internal inductance, max. $L_i$	0 μH	0 μH
Input power, max. $P_i$	0.75 W	0.75 W

Ordering data

Type  
Order No.  
Qty.

	VSSC4 CL FG 24VAC/DC Ex	VSSC4 CL FG 48VAC/DC Ex
	<b>1063810000</b>	<b>1063820000</b>
	5 ST	5 ST
Note	End plate AP VSSC4 LB 1067240000	End plate AP VSSC4 LB 1067240000



## VARITECTOR SSC EX

**VSSC 4 SL FG EX - protection for floating earth, binary, intrinsically safe signals**

- 2-stage surge protection. Screw connection for intrinsically safe measurement, control & feedback control signals
- Terminal block design
- Modular width of only 12.4 mm
- Space-saving design: 1 binary floating ground signal
- Torx® slotted screw connection
- Complies with installation standard IEC 62305 and ATEX applications
- Complies with IEC 61643-21:08 D1, C1, C2, C3
- Integrated PE foot, discharges up to 20 kA (8/20 µs) and 2.5 kA (10/350 µs) to PE

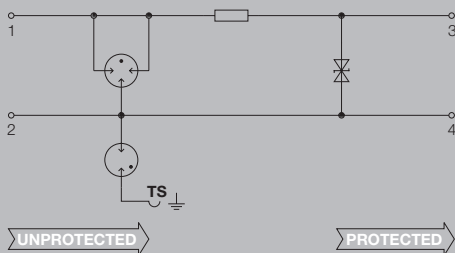
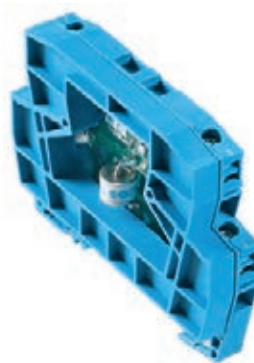
**Technical data**

Dielectric strength at FG against PE	≥ 500 V
Volume resistance	1.8 Ω 10 %
Overload - failure mode	Modus 2
Requirements category acc. to IEC 61643-21	C2, C3, D1
Surge current-carrying capacity C1	
Surge current-carrying capacity C2	2.5 kA 8/20 µs 5 kV 1.2/50 µs
Surge current-carrying capacity C3	10 A 10/1000 µs
Surge current-carrying capacity D1	1 kA 10/350 µs
Discharge current $I_d$ (8/20 µs) wire-wire/wire-PE/GND-PE	/ 2.5 kA / 2.5 kA
Discharge $I_{max}$ (8/20 µs) wire-wire/wire-PE/GND-PE	/ 10 kA / 10 kA
Lightning test $I_{imp}$ (10/350 µs) wire-wire/wire-PE/GND-PE	/ 0.5 kA /
Type of connection	Screw connection, Torx® T15, Slotted 0.8 x 4
Storage temperature	-40 °C...+80 °C
Ambient temperature (operational)	-40 °C...+70 °C
Protection degree	IP 20
UL 94 flammability rating	V-0

**Connection data**

Type of connection	Screw connection, Torx® T15, Slotted 0.8 x 4
Tightening torque	0.5 Nm
Wire connection cross section, finely stranded, max.	4 mm <sup>2</sup>
Wire connection cross-section, finely stranded, min.	0.5 mm <sup>2</sup>
Wire cross-section, solid, max.	6 mm <sup>2</sup>
Wire cross-section, solid, min.	0.5 mm <sup>2</sup>
Wire cross-section, stranded, max.	4 mm <sup>2</sup>
Wire cross-section, stranded, min.	0.5 mm <sup>2</sup>
Stripping length	10 mm
Mounting rail	TS 35

**Failure probability**

ages	
MTTF	
SIL in compliance with IEC 61508	3

**Approvals**

Approvals	CE; DEKRAATEX; IECExDEK; OEVE; TUEV; ROHS
Standards	IEC61643-21:2009, DIN EN 60079-0:2009, DIN EN 60079-26:2007, DIN EN 61241-11:2006
ATEX - dust labelling	II 1 D Ex ia IIC T135 °C ...T85 °C Da
ATEX - gas labelling	II 1 G Ex ia IIC T4... T6 Ga
IECEX - dust labelling	II 1 D Ex ia IIC T135 °C ...T85 °C Da
IECEX - gas labelling	II 1 G Ex ia IIC T4... T6 Ga

**Dimensions**

Height x width x depth	mm	76 / 12.2 / 58.5
------------------------	----	------------------

**Note**

ATEX approval: II 1 G EX ia IIC T4...T6 Ga II 1 D EX ia IIC T135°C...T85°C  
DEKRA No: 11ATEX0023 X

VSSC 4 SL FG EX

Ordering data

Rated voltage (AC)  
Rated voltage (DC)  
Rated current  
Optical function display  
Input attenuation  
Pulse-reset capacity  
Residual voltage,  $U_p$  typical

EX protection data

Input voltage, max.  $U_i$   
Internal capacitance, max.  $C_i$   
Internal inductance, max.  $L_i$   
Input power, max.  $P_i$

VSSC4 SL FG 24 V UC EX

Rated voltage (AC)	24 V
Rated voltage (DC)	34 V
Rated current	300 mA
Optical function display	No
Input attenuation	3.4 MHz
Pulse-reset capacity	≤ 35 ms
Residual voltage, $U_p$ typical	106 V
Input voltage, max. $U_i$	42 V
Internal capacitance, max. $C_i$	1 nF
Internal inductance, max. $L_i$	0 μH
Input power, max. $P_i$	0.75 W

VSSC4 SL FG 48 V UC EX

Rated voltage (AC)	48 V
Rated voltage (DC)	68 V
Rated current	300 mA
Optical function display	No
Input attenuation	5.2 MHz
Pulse-reset capacity	≤ 20 ms
Residual voltage, $U_p$ typical	160 V
Input voltage, max. $U_i$	55 V
Internal capacitance, max. $C_i$	1 nF
Internal inductance, max. $L_i$	0 μH
Input power, max. $P_i$	0.75 W

Ordering data

Type  
Order No.  
Qty.

Type	VSSC4 SL FG 24VAC/DC Ex
Order No.	<b>1063930000</b>
Qty.	5 ST

Type	VSSC4 SL FG 48VAC/DC Ex
Order No.	<b>1063940000</b>
Qty.	5 ST

Note

End plate AP VSSC4 LB 1067240000

End plate AP VSSC4 LB 1067240000



## VARITECTOR SSC EX

## VSSC 4 GDT EX - protection with sparkover gap (GDT)

- One-stage surge protection with screw connection for measurement and control signals
- Surge protection in terminal block design
- Modular width of only 12.4 mm
- Space-saving design for one signal
- Torx® slotted screw connection
- Can be used in compliance with installation standard IEC 62305
- Tested in accordance with IEC 61643-21:08 : C1, C2, C3
- Integrated PE foot, safely discharges up to 20 kA (8/20 μs) and 2.5 kA (10/350 μs) to PE



B

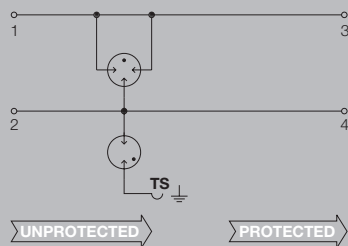

## Technical data

Dielectric strength at FG against PE	≥ 500 V
Volume resistance	< 0.1 Ω
Overload - failure mode	Modus 2
Requirements category acc. to IEC 61643-21	C2, C3, D1
Surge current-carrying capacity C1	
Surge current-carrying capacity C2	5 kA 8/20 μs
Surge current-carrying capacity C3	100 A 10/1000 μs
Surge current-carrying capacity D1	2.5 kA 10/350 μs
Discharge current I <sub>1</sub> (8/20 μs) wire-wire/wire-PE/GND-PE	/ 5 kA /
Discharge I <sub>max</sub> (8/20 μs) wire-wire/wire-PE/GND-PE	/ 20 kA /
Lightning test I <sub>imp</sub> (10/350 μs) wire-wire/wire-PE/GND-PE	
Type of connection	Screw connection, Torx® T15, Slotted 0.8 x 4
Storage temperature	-40 °C...+80 °C
Ambient temperature (operational)	-40 °C...+70 °C
Protection degree	IP 20
UL 94 flammability rating	V-0
<b>Connection data</b>	
Type of connection	Screw connection, Torx® T15, Slotted 0.8 x 4
Tightening torque	0.5 Nm
Wire connection cross section, finely stranded, max.	4 mm <sup>2</sup>
Wire connection cross-section, finely stranded, min.	0.5 mm <sup>2</sup>
Wire cross-section, solid, max.	6 mm <sup>2</sup>
Wire cross-section, solid, min.	0.5 mm <sup>2</sup>
Wire cross-section, stranded, max.	4 mm <sup>2</sup>
Wire cross-section, stranded, min.	0.5 mm <sup>2</sup>
Stripping length	10 mm
Mounting rail	TS 35
<b>Failure probability</b>	
λges	10
MTTF	11416
SIL in compliance with IEC 61508	3
<b>Approvals</b>	
Approvals	CE; DEKRAATEX; IECXDEK; TUEV; ROHS
Standards	IEC61643-21:2009, DIN EN 60079-0:2009, DIN EN 60079-26:2007, DIN EN 61241-11:2006
ATEX - dust labelling	II 1 D Ex ia IIC T135 °C ...T85 °C Da
ATEX - gas labelling	II 1 G Ex ia IIC T4... T6 Ga
IECEx - dust labelling	II 1 D Ex ia IIC T135 °C ...T85 °C Da
IECEx - gas labelling	II 1 G Ex ia IIC T4... T6 Ga
<b>Dimensions</b>	
Height x width x depth	mm 76 / 12.2 / 58.5
<b>Note</b>	
ATEX approval: II 1 G EX ia IIC T4...T6 Ga II 1 D EX ia IIC T135°C...T85°C DEKRA No: 11ATEX0023 X	

## VSSC 4 GDT EX

## Ordering data

Ordering data	VSSC4 GDT 55 V UC 20 kA EX
Rated voltage (AC)	55 V
Rated voltage (DC)	38 V
Rated current	300 mA
Optical function display	No
Residual voltage, $U_r$ , typical	845 V
Capacitance	4.65 pF
EX protection data	
Input voltage, max. $U_i$	55 V
Internal capacitance, max. $C_i$	0 nF
Internal inductance, max. $L_i$	0 $\mu$ H
Input power, max. $P_i$	0.75 W

Ordering data	
Type	VSSC4 GDT55VUC 20kA EX
Order No.	<b>1064040000</b>
Qty.	5 ST
Note	End plate AP VSSC4 LB 1067240000

B



**VSSC 6 TR CL FG EX - protection for floating, intrinsically safe current loops with isolator function**

- 2-stage surge protection. Screw connection for intrinsically safe measurement, control & feedback control signals
- Terminal block design
- Modular width 6.2 mm
- Signals can be separated for measurement
- Use in zones 2, 1, and 0
- Torx® slotted screw connection
- Complies with IEC 62305 and IEC 61643-21: D1, C2, C3
- Integrated PE foot, safely discharges up to 20 kA (8/20 µs) & 2.5 kA (10/350 µs) to PE

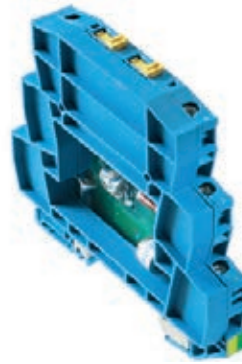

**Technical data**

Dielectric strength at FG against PE	≥ 500 V
Volume resistance	1.8 Ω 10 %
Overload - failure mode	Modus 2
Requirements category acc. to IEC 61643-21	C2, C3, D1
Surge current-carrying capacity C1	
Surge current-carrying capacity C2	2.5 kA 8/20 µs 5 kV 1.2/50 µs
Surge current-carrying capacity C3	50 A 10/1000 µs
Surge current-carrying capacity D1	0.5 kA 10/350 µs
Discharge current I <sub>d</sub> (8/20 µs) wire-wire/wire-PE/GND-PE	2.5 kA / 2.5 kA /
Discharge I <sub>max</sub> (8/20 µs) wire-wire/wire-PE/GND-PE	5 kA / 5 kA /
Lightning test I <sub>imp</sub> (10/350 µs) wire-wire/wire-PE/GND-PE	/ 0.5 kA /
Type of connection	Screw connection, Torx® T15, Slotted 0.8 x 4
Storage temperature	-40 °C...+80 °C
Ambient temperature (operational)	-40 °C...+70 °C
Protection degree	IP 20
UL 94 flammability rating	V-0

<b>Connection data</b>	
Type of connection	Screw connection, Torx® T15, Slotted 0.8 x 4
Tightening torque	0.5 Nm
Wire connection cross section, finely stranded, max.	4 mm <sup>2</sup>
Wire connection cross-section, finely stranded, min.	0.5 mm <sup>2</sup>
Wire cross-section, solid, max.	6 mm <sup>2</sup>
Wire cross-section, solid, min.	0.5 mm <sup>2</sup>
Wire cross-section, stranded, max.	4 mm <sup>2</sup>
Wire cross-section, stranded, min.	0.5 mm <sup>2</sup>
Stripping length	10 mm
Mounting rail	TS 35

<b>Failure probability</b>	
λ <sub>ges</sub>	19
MTTF	6008
SIL in compliance with IEC 61508	2

<b>Approvals</b>	
Approvals	CE; DEKRAATEX; IECExDEK; TUEV; ROHS
Standards	IEC61643-21:2009, DIN EN 60079-0:2009, DIN EN 60079-26:2007, DIN EN 61241-11:2006

ATEX - dust labelling	II 1 D Ex ia IIC T135 °C ...T85 °C Da
ATEX - gas labelling	II 1 G Ex ia IIC T4... T6 Ga
IECEX - dust labelling	II 1 D Ex ia IIC T135 °C ...T85 °C Da
IECEX - gas labelling	II 1 G Ex ia IIC T4... T6 Ga

<b>Dimensions</b>	
Height x width x depth	mm 88.5 / 12.2 / 81

<b>Note</b>	ATEX approval: II 1 G EX ia IIC T4...T6 Ga II 1 D EX ia IIC T135°C...T85°C DEKRA No: 11ATEX0023 X
-------------	---

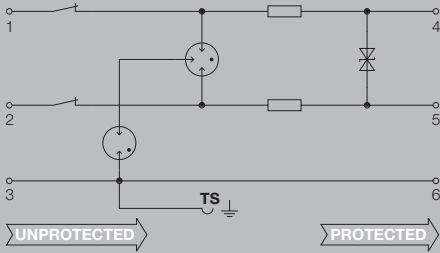

## VSSC 6 TR CL FG EX

## Ordering data

Ordering data		VSSC6 TR CLFG 24 V UC EX
Rated voltage (AC)		24 V
Rated voltage (DC)		34 V
Rated current		300 mA
Optical function display		No
Input attenuation		270 MHz
Pulse-reset capacity		≤ 20 ms
Residual voltage, $U_r$ typical		1632 V
EX protection data		
Input voltage, max. $U_i$		42 V
Internal capacitance, max. $C_i$		1 nF
Internal inductance, max. $L_i$		0 μH
Input power, max. $P_i$		0.75 W

Ordering data		
Type		VSSC6TRCLFG24VAC/DC EX
Order No.		<b>1066490000</b>
Qty.		5 ST
Note		End plate AP VSSC LB 1067230000



**VSSC 6 RS485 PROFIBUS PA - protection for RS422/485 intrinsically safe signal interfaces**

- Two-stage surge protection with screw connection for PROFIBUS PA RS422/485 data interfaces
- Surge protection in terminal block design
- Modular width of only 6.2 mm
- For use in zones 2, 1, and 0
- Space-saving design: 1 signal
- Torx® slotted screw connection
- Can be used in compliance with installation standard IEC 62305
- Tested in accordance with IEC 61643-21: D1, C2, C3
- Integrated PE foot, safely discharges up to 20 kA (8/20 µs) and 2.5 kA (10/350 µs) to PE



**Technical data**

Dielectric strength at FG against PE	≥ 500 V
Volume resistance	1.8 Ω 10 %
Overload - failure mode	Modus 2
Requirements category acc. to IEC 61643-21	C2, C3, D1
Surge current-carrying capacity C1	
Surge current-carrying capacity C2	2.5 kA 8/20 µs 5 kV 1.2/50 µs
Surge current-carrying capacity C3	10 A 10/1000 µs
Surge current-carrying capacity D1	0.5 kA 10/350 µs
Discharge current I <sub>d</sub> (8/20 µs) wire-wire/wire-PE/GND-PE	2.5 kA / 2.5 kA /
Discharge I <sub>max</sub> (8/20 µs) wire-wire/wire-PE/GND-PE	5 kA / 5 kA /
Lightning test I <sub>imp</sub> (10/350 µs) wire-wire/wire-PE/GND-PE	/ 0.5 kA /
Type of connection	Screw connection, Torx® T15, Slotted 0.8 x 4
Storage temperature	-40 °C...+80 °C
Ambient temperature (operational)	-40 °C...+70 °C
Protection degree	IP 20
UL 94 flammability rating	V-0

<b>Connection data</b>	
Type of connection	Screw connection, Torx® T15, Slotted 0.8 x 4
Tightening torque	0.5 Nm
Wire connection cross section, finely stranded, max.	4 mm <sup>2</sup>
Wire connection cross-section, finely stranded, min.	0.5 mm <sup>2</sup>
Wire cross-section, solid, max.	6 mm <sup>2</sup>
Wire cross-section, solid, min.	0.5 mm <sup>2</sup>
Wire cross-section, stranded, max.	4 mm <sup>2</sup>
Wire cross-section, stranded, min.	0.5 mm <sup>2</sup>
Stripping length	10 mm
Mounting rail	TS 35

<b>Failure probability</b>	
λges	29
MTTF	3936
SIL in compliance with IEC 61508	3

<b>Approvals</b>	
Approvals	CE; DEKRAATEX; IECExDEK; TUEV; ROHS
Standards	IEC61643-21:2009, DIN EN 60079-0:2009, DIN EN 60079-26:2007, DIN EN 61241-11:2006

ATEX - dust labelling	II 1 D Ex ia IIC T135 °C ...T85 °C Da
ATEX - gas labelling	II 1 G Ex ia IIC T4... T6 Ga
IECEx - dust labelling	II 1 D Ex ia IIC T135 °C ...T85 °C Da
IECEx - gas labelling	II 1 G Ex ia IIC T4... T6 Ga

<b>Dimensions</b>	
Height x width x depth	mm 88.5 / 12.2 / 81

<b>Note</b>	ATEX approval: II 1 G EX ia IIC T4...T6 Ga II 1 D EX ia IIC T135°C...T85°C DEKRA No: 11ATEX0023 X
-------------	---

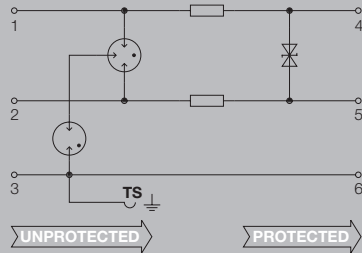

## VSSC 6 RS485 PROFIBUS PA

## Ordering data

Ordering data		VSSC6 RS485 PA EX
Rated voltage (AC)		
Rated voltage (DC)		12 V
Rated current		300 mA
Optical function display		No
Input attenuation		113.6 MHz
Pulse-reset capacity		≤ 15 ms
Residual voltage, $U_r$ typical		94 V
EX protection data		
Input voltage, max. $U_i$		35 V
Internal capacitance, max. $C_i$		1 nF
Internal inductance, max. $L_i$		0 μH
Input power, max. $P_i$		0.75 W

Ordering data		
Type		VSSC6 RS485 PA EX
Order No.		<b>1065020000</b>
Qty.		5 ST
Note		End plate AP VSSC LB 1067230000

B



## VARITECTOR SSC EX

**VSSC 6 RTD EX - protection for intrinsically safe  
PT100 signal interfaces**

- Two-stage surge protection with screw connection for intrinsically safe PT100/PT1000 signals
- Surge protection in terminal block design
- Modular width of only 12.4 mm
- Torx® slotted screw connection
- Can be used in compliance with installation standard IEC 62305
- Tested in accordance with IEC 61643-21: D1, C2, C3
- Integrated PE foot, safely discharges up to 20 kA (8/20  $\mu$ s) and 2.5 kA (10/350  $\mu$ s) to PE

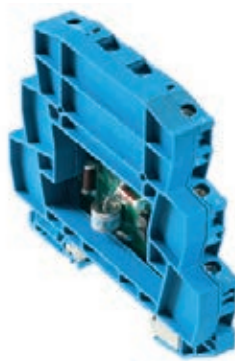

B

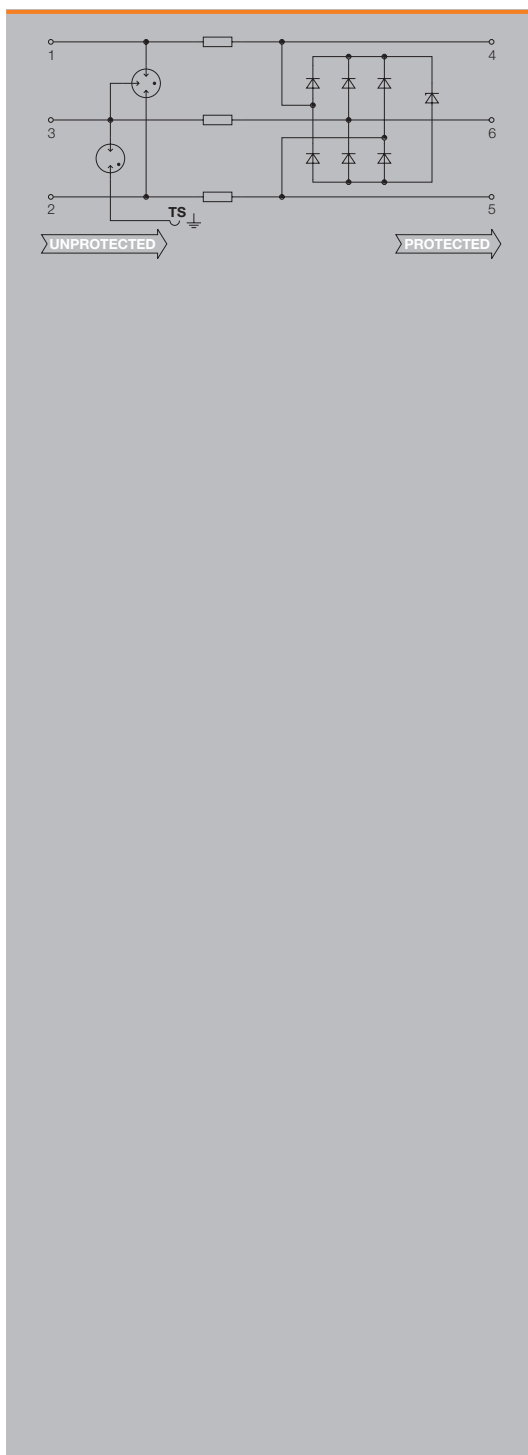
**Technical data**

Dielectric strength at FG against PE	$\geq 500$ V
Volume resistance	1.8 $\Omega$ 10 %
Overload - failure mode	Modus 2
Requirements category acc. to IEC 61643-21	C2, D1
Surge current-carrying capacity C1	
Surge current-carrying capacity C2	2.5 kA 8/20 $\mu$ s 5 kV 1.2/50 $\mu$ s
Surge current-carrying capacity C3	10 A 10/1000 $\mu$ s
Surge current-carrying capacity D1	0.5 kA 10/350 $\mu$ s
Discharge current $I_t$ (8/20 $\mu$ s) wire-wire/wire-PE/GND-PE	2.5 kA / 2.5 kA /
Discharge $I_{max}$ (8/20 $\mu$ s) wire-wire/wire-PE/GND-PE	5 kA / 5 kA /
Lightning test $I_{imp}$ (10/350 $\mu$ s) wire-wire/wire-PE/GND-PE	/ 0.5 kA /
Type of connection	Screw connection, Torx® T15, Slotted 0.8 x 4
Storage temperature	-40 °C...+80 °C
Ambient temperature (operational)	-40 °C...+70 °C
Protection degree	IP 20
UL 94 flammability rating	V-0
<b>Connection data</b>	
Type of connection	Screw connection, Torx® T15, Slotted 0.8 x 4
Tightening torque	Nm
Wire connection cross section, finely stranded, max.	4 mm <sup>2</sup>
Wire connection cross-section, finely stranded, min.	0.5 mm <sup>2</sup>
Wire cross-section, solid, max.	6 mm <sup>2</sup>
Wire cross-section, solid, min.	0.5 mm <sup>2</sup>
Wire cross-section, stranded, max.	4 mm <sup>2</sup>
Wire cross-section, stranded, min.	0.5 mm <sup>2</sup>
Stripping length	mm
Mounting rail	TS 35
<b>Failure probability</b>	
$\lambda_{ges}$	61
MTTF	1871
SIL in compliance with IEC 61508	3
<b>Approvals</b>	
Approvals	CE; DEKRAATEX; IECXDEK; TUEV; ROHS
Standards	IEC61643-21:2009, DIN EN 60079-0:2009, DIN EN 60079-26:2007, DIN EN 61241-11:2006
ATEX - dust labelling	II 1 D Ex ia IIC T135 °C ...T85 °C Da
ATEX - gas labelling	II 1 G Ex ia IIC T4... T6 Ga
IECEx - dust labelling	II 1 D Ex ia IIC T135 °C ...T85 °C Da
IECEx - gas labelling	II 1 G Ex ia IIC T4... T6 Ga
<b>Dimensions</b>	
Height x width x depth	mm 88.5 / 12.2 / 81
<b>Note</b>	
ATEX approval: II 1 G EX ia IIC T4...T6 Ga II 1 D EX ia IIC T135°C...T85°C DEKRA No: 11ATEX0023 X	

## VSSC 6 RTD EX

## Ordering data

Rated voltage (AC)  
 Rated voltage (DC)  
 Rated current  
 Optical function display  
 Input attenuation  
 Pulse-reset capacity  
 Residual voltage,  $U_r$  typical

## VSSC6 RTD EX

1 V

300 mA

No

120 MHz

 $\leq 10$  ms

## EX protection data

Input voltage, max.  $U_i$   
 Internal capacitance, max.  $C_i$   
 Internal inductance, max.  $L_i$   
 Input power, max.  $P_i$

5 V

7 nF

0  $\mu$ H

0.75 W

## Ordering data

Type  
 Order No.  
 Qty.

VSSC6 RTD EX

**1130670000**

5 ST

## Note

End plate AP VSSC LB 1067230000

B



# Approval – VSPC-ATEX



**KEMA Quality**  
— a DEKRA company

(1) **EC-TYPE EXAMINATION CERTIFICATE**

(2) **Equipment and protective systems intended for use in potentially explosive atmospheres - Directive 94/9/EC**

(3) EC-Type Examination Certificate Number: KEMA 10ATEX0148 X Issue Number: 1

(4) Equipment: Surge Voltage Protection Unit, Type VSPC ... Ex

(5) Manufacturer: Weidmüller Interface GmbH & Co. KG

(6) Address: Kingenbergsstraße 16, 32758 Detmold, Germany

(7) This equipment and any acceptable variation thereto is specified in the schedule to this certificate and the documents therein referred to.

(8) KEMA Quality B.V., notified body number 0344 in accordance with Article 9 of the Council Directive 94/9/EC of 23 March 1994, certifies that this equipment has been found to comply with the Essential Health and Safety Requirements relating to the design and construction of equipment and protective systems intended for use in potentially explosive atmospheres given in Annex II to the directive.

The examination and test results are recorded in confidential test report number 213064900.

(9) Compliance with the Essential Health and Safety Requirements has been assured by compliance with:

EN 60079-0 : 2009 EN 60079-11 : 2007  
EN 60079-26 : 2007 EN 61241-11 : 2006

(10) If the sign "C" is placed after the certificate number, it indicates that the equipment is subject to special conditions for safe use specified in the schedule to this certificate.

(11) This EC-Type Examination Certificate relates only to the design, examination and tests of the specified equipment according to the Directive 94/9/EC. Further requirements of the directive apply to the manufacturing process and supply of this equipment. These are not covered by this certificate.

(12) The marking of the equipment shall include the following:

II G Ex Ia IIC T4 ... T6 Ga  
OF  
II D Ex Ia IIIC T135 °C ... T85 °C Da

This certificate is issued on November 8, 2010 and, as far as applicable, shall be revised before the date of cessation of presumption of conformity of (one of) the standards mentioned above as communicated in the Official Journal of the European Union.

KEMA Quality B.V.  
*[Signature]*  
C.G. Van Es  
Certification Manager

Page 1/3

\* Integral publication of this certificate and adjoining reports is allowed. This Certificate may only be reproduced in its entirety and without any change.

KEMA Quality B.V. Utrechtseweg 310, 6812 AR Arnhem P.O. Box 5185, 6802 ED Arnhem The Netherlands  
T +31 26 3 56 20 00 F +31 26 3 52 58 00 www.kemaquality.com Registered Arnhem 09085396

**DEKRA company**

**KEMA Quality**  
— a DEKRA company

(13) **SCHEDULE**

(14) to EC-Type Examination Certificate KEMA 10ATEX0148 X Issue No. 1

(15) **Description**

The Surge Voltage Protection Unit of Series VSPC ... Ex serves to limit eventual surge voltages in intrinsically safe circuits.

The Units consist out of a Base Module for rail mounting and a pluggable protection Module provided with a (for each Base Module type) unique mechanical key.

The Plug-in unit Type VSPC 1CL PW 24Vac EX also contains a LED error-indicator.

Several units for different intrinsically safe circuits may be mounted next to each other.

**Electrical data**

Input circuit (Terminals 1, 5, 7 and 11):  
in type of protection intrinsic safety Ex ia IIC or Ex ia IIIC, only for connection to a certified intrinsically safe circuit, with the following maximum values:  
L<sub>i</sub> = 0 µH; C<sub>i</sub> = 25 nF (for Type VSPC 1CL PW 24VAC EX); C<sub>i</sub> = 4 nF (for the other Types).

The values of U<sub>i</sub> for the different types of pluggable modules are listed in the following table:

Pluggable protection Module Types	U <sub>i</sub>
VSPC ... 5VDC EX	6 V
VSPC ... 12VDC EX	14 V
VSPC ... 12VAC EX	19 V
VSPC ... 24VDC EX	26 V
VSPC 1CL PW 24VAC EX	27 V
VSPC ... 24VAC EX	38 V
VSPC ... 48VAC EX	75 V

MEAN-P-Ex00 V1.0

Page 2/3

**KEMA Quality**  
— a DEKRA company

(13) **SCHEDULE**

(14) to EC-Type Examination Certificate KEMA 10ATEX0148 X Issue No. 1

The temperature class / maximum surface temperature of the Base modules, depending on I<sub>i</sub> and the ambient temperature range is listed in the following table:

Base Module Type	I <sub>i</sub>	Ambient temperature range	Temperature class / Maximum surface temperature
VSPC BASE 4SL FG EX	250 mA	-40 to +60 °C	T8 / T85 °C
VSPC BASE 2CL FG EX	250 mA	-40 to +75 °C	T5 / T100 °C
VSPC BASE 1CL PW FG EX	350 mA	-40 to +85 °C	T4 / T135 °C
		-40 to +60 °C	T8 / T85 °C
VSPC BASE 2CH FG EX	3,3 A	-40 to +75 °C	T5 / T100 °C
		-40 to +85 °C	T4 / T135 °C

Output circuits (Terminals 2, 6, 8 and 12):  
in type of protection intrinsic safety Ex ia IIC or Ex ia IIIC. The output parameters are equal to the output parameters of the external intrinsically safe circuits connected to the input circuit. For the determination of the maximum allowed external capacitance (C<sub>e</sub>) and inductance (L<sub>e</sub>), the values of the internal capacitance (C<sub>i</sub>) and inductance (L<sub>i</sub>) shall be taken into account.

**Installation instructions**

The instructions, provided by the manufacturer, shall be followed in detail to assure safe operation of the equipment.

(16) **Test Report**  
KEMA No. 213064900.

(17) **Special conditions for safe use**

For application in explosive dust atmospheres:  
The Surge Voltage Protection Units shall be installed in an enclosure, which complies with the requirements of EN 60079-0 and EN 61241-1-1, providing a degree of protection of at least IP6X in accordance with EN 60529. The maximum surface temperature of the enclosure is specified in the description (15).

For application in explosive gas atmospheres:  
Measures shall be taken to avoid the danger of ignition due to electrostatic charges.

(18) **Essential Health and Safety Requirements**  
Covered by the standards listed at (9).

(19) **Test documentation**  
As listed in Test Report No. 213064900.

MEAN-P-Ex00 V1.0

Page 3/3

## Approval – VSSC-ATEX

**DEKRA**

## CERTIFICATE

(1) **EC-Type Examination**

(2) **Equipment and protective systems intended for use in potentially explosive atmospheres - Directive 94/9/EC**

(3) EC-Type Examination Certificate Number: **DEKRA 11ATEX0023 X** Issue Number: **1**

(4) **Equipment:** Surge Voltage Protection Unit, Series VSSC ... Ex

(5) **Manufacturer:** Weidmüller Interface GmbH & Co. KG

(6) **Address:** Klängenbergstraße 16, 32758 Detmold, Germany

(7) This equipment and any acceptable variation thereto is specified in the schedule to this certificate and the documents therein referred to.

(8) DEKRA Certification B.V., notified body number 0344 in accordance with Article 9 of the Council Directive 94/9/EC of 23 March 1994, certifies that this equipment has been found to comply with the Essential Health and Safety Requirements relating to the design and construction of equipment and protective systems intended for use in potentially explosive atmospheres given in Annex II to the directive. The examination and test results are recorded in confidential test report number NL/DEK/EXTR11.0016\*\*\*.

(9) Compliance with the Essential Health and Safety Requirements has been assured by compliance with:  
**EN 60079-0 : 2009**      **EN 60079-11 : 2007**  
**EN 60079-26 : 2007**      **EN 61241-11 : 2006**

(10) If the sign 'X' is placed after the certificate number, it indicates that the equipment is subject to special conditions for safe use specified in the schedule to this certificate.

(11) This EC-Type Examination Certificate relates only to the design, examination and tests of the specified equipment according to the Directive 94/9/EC. Further requirements of the directive apply to the manufacturing process and supply of this equipment. These are not covered by this certificate.

(12) The marking of the equipment shall include the following:

 **II 1 G Ex ia IIC T4 ... T6 Ga**  
**or**  
**II 1 D Ex ia IIIC T135 °C ... T85 °C Da**

This certificate is issued on April 27, 2011 and, as far as applicable, shall be revised before the date of cessation of presumption of conformity of (one of) the standards mentioned above as communicated in the Official Journal of the European Union.

DEKRA Certification B.V.  
  
T. Pijpkor  
Certification Manager

Page 1/3

\* Integral publication of this certificate and adjoining reports is allowed. This Certificate may only be reproduced in its entirety and without any change.

 All testing, inspection, auditing and certification activities of the former KEMA Quality are an integral part of the DEKRA Certification Group

DEKRA Certification B.V. Utrechtseweg 310, 6812 AR Arnhem P.O. Box 5185, 6802 ED Arnhem The Netherlands  
T +31 26 3 56 20 00 F +31 26 3 52 58 50 www.dekra-certification.com Registered Arnhem 0005336

**DEKRA**

(13) **SCHEDULE**

(14) **to EC-Type Examination Certificate DEKRA 11ATEX0023 X** Issue No. **1**

(15) **Description**

The Surge Voltage Protection Unit of Series VSSC ... Ex serves to limit any surge voltages in intrinsically safe circuits.

The earth connection can be made via the mounting foot to a normalized metal mounting rail and via a terminal.

Several units for different intrinsically safe circuits may be mounted next to each other.

Ambient temperature range:    -40 °C to +70 °C (T6 / T85 °C),  
   -40 °C to +85 °C (T5 / T100 °C),  
   -40 °C to +120 °C (T4 / T135 °C).

**Electrical data**

Input circuit (Terminals 1, 2):  
in type of protection intrinsic safety Ex ia IIC or Ex ia IIIC, only for connection to a certified intrinsically safe circuit, with the following maximum values:  
I = 300 mA, P = 0,75 W, L = 0 µH  
The values of U and C, for the different types are listed in the following table:

Type	U	C
VSSC4 CL FG 24Vuc EX	42V	1 nF
VSSC4 CL FG 48Vuc EX	55 V	1 nF
VSSC4 SL FG 24Vuc EX	42V	1 nF
VSSC4 SL FG 48Vuc EX	55 V	1 nF
VSSC4 GDT 55Vuc 20kA EX	55V	0 nF
VSSC6 TR CL FG 24Vuc EX	42V	1 nF
VSSC6 RS485 PA EX	35 V	1 nF
VSSC6 RTD EX	5 V	7 nF

Output circuit (Terminals 3, 4):  
in type of protection intrinsic safety Ex ia IIC or Ex ia IIIC. The output parameters are equal to the output parameters of the external intrinsically safe circuit connected to the input circuit.  
For the determination of the maximum allowed external capacitance (C<sub>e</sub>) and inductance (L<sub>e</sub>), the values of the internal capacitance (C<sub>i</sub>) and inductance (L<sub>i</sub>) shall be taken into account.

**Installation instructions**

The instructions provided by the manufacturer shall be followed in detail to assure safe operation of the equipment.

(16) **Test Report**

No. NL/DEK/EXTR11.0016\*\*\*.

Page 2/3

Form 100  
Version 1 (2010-12)

**DEKRA**

(13) **SCHEDULE**

(14) **to EC-Type Examination Certificate DEKRA 11ATEX0023 X** Issue No. **1**

(17) **Special conditions for safe use**

The intrinsic safe signal of Surge Voltage Protection Unit, Type VSSC4 GDT 55V EX, is directly connected to earth.

For ambient temperature range, see (15).

(18) **Essential Health and Safety Requirements**

Covered by the standards listed at (9).

(19) **Test documentation**

As listed in Test Report No. NL/DEK/EXTR11.0016\*\*\*.

Page 3/3

Form 100  
Version 1 (2010-12)

## Approval – VSSC-IEC Ex

**IECEx Certificate of Conformity**

INTERNATIONAL ELECTROTECHNICAL COMMISSION  
IEC Certification Scheme for Explosive Atmospheres  
for rules and details of the IECEx Scheme visit [www.iecex.com](http://www.iecex.com)

Certificate No.: IECEx DEK 11.0020X Issue No.: 0 Certificate history:

Status:

Date of issue: 2011-05-24 Page 1 of 3

Applicant: Weidmüller Interface GmbH & Co. KG  
Klingenbergerstraße 16, 32758 Demold  
Germany

Electrical Apparatus: Surge Voltage Protection Unit, Series VSSC ... Ex  
Optional accessory:

Type of Protection: Ex ia

Marking: Ex ia IIC T4 ... T6 Ga or  
Ex ia IIC T135 °C ... T85 °C Da

Approved for issue on behalf of the IECEx: T. Pijker  
Certification Body:

Position: Certification Manager

Signature:   
(for printed version)

Date: 2011-05-24

1. This certificate and schedule may only be reproduced in full.  
2. This certificate is not transferable and remains the property of the issuing body.  
3. The Status and authenticity of this certificate may be verified by visiting the Official IECEx Website.

Certificate issued by: **DEKRA** Certification B.V.  
Ulrechtseweg 310  
6812 AR Arnhem  
The Netherlands

All testing, inspection, auditing and certification activities of the former KEMA Quality are an integral part of the DEKRA Certification Group.



**IECEx Certificate of Conformity**

Certificate No.: IECEx DEK 11.0020X Issue No.: 0  
Date of issue: 2011-05-24 Page 2 of 3

Manufacturer: Weidmüller Interface GmbH & Co. KG  
Klingenbergerstraße 16, 32758 Demold  
Germany

Manufacturing location(s):  
Weidmüller Interface GmbH & Co. KG  
Klingenbergerstraße 16, 32758 Demold  
Germany

This certificate is issued as verification that a sample(s), representative of production, was assessed and tested and found to comply with the IEC Standard list below and that the manufacturer's quality system, relating to the Ex products covered by this certificate, was assessed and found to comply with the IECEx Quality system requirements. This certificate is granted subject to the conditions as set out in IECEx Scheme Rules, IECEx Q2 and Operational Documents as amended.

**STANDARDS:**  
The electrical apparatus and any acceptable variations to it specified in the schedule of this certificate and the identified documents, was found to comply with the following standards:

**IEC 60079-0 : 2007-10** Explosive atmospheres - Part 0: Equipment - General requirements  
Edition: 5

**IEC 60079-11 : 2006** Explosive atmospheres - Part 11: Equipment protection by intrinsic safety "I"  
Edition: 5

**IEC 60079-26 : 2006** Explosive atmospheres - Part 26: Equipment with equipment protection level (EPL) Ga  
Edition: 2

**IEC 61241-11 : 2005** Electrical apparatus for use in the presence of combustible dusts - Part 11: Protection by intrinsic safety "D"  
Edition: 1

This Certificate does not indicate compliance with electrical safety and performance requirements other than those expressly included in the Standards listed above.

**TEST & ASSESSMENT REPORTS:**  
A sample(s) of the equipment listed has successfully met the examination and test requirements as recorded in

Test Report:  
NLDEKEXTR11.0016/00

Quality Assessment Report:  
NLKEMQAR06.0006/06

**IECEx Certificate of Conformity**

Certificate No.: IECEx DEK 11.0020X Issue No.: 0  
Date of issue: 2011-05-24 Page 3 of 3

**Schedule**

**EQUIPMENT:**  
Equipment and systems covered by this certificate are as follows:  
The Surge Voltage Protection Unit of Series VSSC ... Ex serves to limit any surge voltages in intrinsically safe circuits.  
For further details such as thermal and electrical data: see Attachment.

**CONDITIONS OF CERTIFICATION: YES as shown below:**  
The intrinsic safe signal of Surge Voltage Protection Unit Type VSSC4 GDT 55V EX, is directly connected to earth (PE).  
For ambient temperature range: see attachment.

Annexe: Attachment to IECEx DEK 11.0020 X.pdf

**DEKRA**

**Annex 1 to Certificate of Conformity IECEx DEK 11.0020X, issue 0**

**General product information:**  
The Surge Voltage Protection Unit of Series VSSC ... Ex serves to limit any surge voltages in intrinsically safe circuits.  
The earth connection can be made via the mounting foot to a normalized metal mounting rail and via a terminal.  
Several units for different intrinsically safe circuits may be mounted next to each other.

**Thermal data**  
Ambient temperature range: -40 °C to +70 °C (T6 / T85 °C),  
-40 °C to +85 °C (T5 / T100 °C),  
-40 °C to +120 °C (T4 / T135 °C).

**Electrical data**  
Input circuit (Terminals 1, 2):  
in type of protection intrinsic safety Ex ia IIC or Ex ia IIC, only for connection to a certified intrinsically safe circuit, with the following maximum values:  
I = 300 mA; L = 0 µH; P = 0.75 W.  
The values of U<sub>i</sub> and C<sub>i</sub> for the different types are listed in the following table:

Type	U <sub>i</sub>	C <sub>i</sub>
VSSC4 CL FG 24Vuc EX	42V	1 nF
VSSC4 CL FG 48Vuc EX	55 V	1 nF
VSSC4 SL FG 24Vuc EX	42V	1 nF
VSSC4 SL FG 48Vuc EX	55 V	1 nF
VSSC4 GDT 55Vuc 20kA EX	55V	0 nF
VSSC6 TR CL FG 24Vuc EX	42V	1 nF
VSSC6 RS485 PA EX	35 V	1 nF
VSSC6 RTD EX	5 V	7 nF

Output circuit (Terminals 3, 4):  
in type of protection intrinsic safety Ex ia IIC or Ex ia IIC. The output parameters are equal to the output parameters of the external intrinsically safe circuit connected to the input circuit.  
For the determination of the maximum allowed external capacitance (C<sub>e</sub>) and inductance (L<sub>e</sub>), the values of the internal capacitance (C<sub>i</sub>) and inductance (L<sub>i</sub>) shall be taken into account.

Page 1 of 1  
Form 124  
Version 1 (2011-02)  
DEKRA Certification B.V., Ulrechtseweg 310, 6812 AR Arnhem P.O. Box 5185, 6802 ED Arnhem The Netherlands  
T +31 26 3 56 20 00 F +31 26 3 52 56 00 [www.dekra-certification.com](http://www.dekra-certification.com) Registered Arnhem 09085396



# Approval – VSPC-IEC Ex

**IECEx Certificate of Conformity**  
 INTERNATIONAL ELECTROTECHNICAL COMMISSION  
 IEC Certification Scheme for Explosive Atmospheres

Certificate No.: IECEx DEK 11.0086X Issue No.: 0  
 Status: Current  
 Date of Issue: 2011-10-12 Page 1 of 3

Applicant: Weidmüller Interface GmbH & Co. KG  
 Königsbergstraße 16  
 32758 Detmold  
 Germany

Electrical Apparatus: Surge Voltage Protection Unit Series VSPC...Ex  
 Optional accessory:  
 Type of Protection: Ex ia  
 Marking: Ex ia IIC T4 ... T8 Gc  
 or Ex ia IIC T135 °C ... T85 °C Gc

Approved for issue on behalf of the IECEx: C.G. van Es  
 Certification body: DEKRA Certification B.V.  
 Signature: [Signature] Date: 2011-10-12

1. This certificate and schedule may only be reproduced in full.  
 2. This certificate is not transferable and remains the property of the issuing body.  
 3. The status and authenticity of this certificate may be verified by visiting the Official IECEx Website.

Certificate issued by: DEKRA Certification B.V.  
 Middelweg 219  
 3812 AD Amstelveen  
 The Netherlands

All testing, inspection, auditing and certification activities of the former KEMA Quality are an integral part of the DEKRA Certification Group.

**IECEx Certificate of Conformity**

Certificate No.: IECEx DEK 11.0086X  
 Date of Issue: 2011-10-12 Issue No.: 0  
 Page 2 of 3

Manufacturer: Weidmüller Interface GmbH & Co. KG  
 Königsbergstraße 16  
 32758 Detmold  
 Germany

Manufacturing location(s):

This certificate is issued as verification that a sample(s), representative of production, was assessed and tested and found to comply with the IEC Standard set below and that the manufacturer's quality system, relating to the Ex products covered by this certificate, was assessed and found to comply with the IECEx Quality system requirements. This certificate is granted subject to the conditions as set out in IECEx Scheme Rules, IECEx Q2 and Operational Documents as amended.

**STANDARDS:**  
 The electrical apparatus and any acceptable variations to it specified in the schedule of this certificate and the identified documents, was found to comply with the following standards:

IEC 60079-0 : 2007-10 Explosive atmospheres - Part 0: Equipment - General requirements  
 Edition: 0  
 IEC 60079-11 : 2006 Explosive atmospheres - Part 11: Equipment protection by intrinsic safety "I"  
 Edition: 5  
 IEC 60079-26 : 2006 Explosive atmospheres - Part 26: Equipment with equipment protection level (EPL) Gc  
 Edition: 2  
 IEC 61241-11 : 2005 Electrical apparatus for use in the presence of combustible dusts - Part 11: Protection by intrinsic safety "ID"  
 Edition: 1

This Certificate does not indicate compliance with electrical safety and performance requirements other than those expressly included in the Standards listed above.

**TEST & ASSESSMENT REPORTS:**  
 A sample(s) of the equipment listed has successfully met the examination and test requirements as recorded in:

Test Report:  
 NL/DEK/EXTR11.0099/00

Quality Assessment Report:  
 NL/KEMQAR06.0006/07

**IECEx Certificate of Conformity**

Certificate No.: IECEx DEK 11.0086X  
 Date of Issue: 2011-10-12 Issue No.: 0  
 Page 3 of 3

**Schedule**

**EQUIPMENT:**  
 Equipment and systems covered by this certificate are as follows:  
 See Attachment to IECEx DEK 11.0086 X Issue 0

**CONDITIONS OF CERTIFICATION: YES as shown below:**

For application in explosive dust atmospheres:  
 The Surge Voltage Protection Units shall be installed in an enclosure, which complies with the requirements of IEC 60079-0 and IEC 61241-11, providing a degree of protection of at least IP6X in accordance with IEC 60529. The maximum surface temperature of the enclosure is specified in the Attachment.

For application in explosive gas atmospheres:  
 Measures shall be taken to avoid the danger of ignition due to electrostatic charges.

Annexe: Attachment to IECEx DEK 11.0086X, Issue 0.pdf

**Attachment 1 to IECEx DEK 11.0086 X, Issue 0**

**General product information:**

The Surge Voltage Protection Unit of Series VSPC...Ex serves to limit eventual surge voltages in intrinsically safe circuits.

The Units consist out of a Base unit for rail mounting and a pluggable protection Module provided with a (for each Unit Model) unique mechanical key.

The Plug-in unit Type VSPC 1CL PW 24VAc EX also contains a LED error-indication.

Several units for different intrinsically safe circuits may be mounted next to each other.

**Electrical data**

Input circuit (Terminals 1, 5, 7 and 11):  
 in type of protection intrinsic safety Ex ia IIC or Ex ia IIC, only for connection to a certified intrinsically safe circuit, with the following maximum values:  
 $L_s = 0 \mu\text{H}$ ;  $C_s = 25 \text{ nF}$  (for Type VSPC 1CL PW 24VAC EX);  
 $C_s = 4 \text{ nF}$  (for the other Types).

The values of U<sub>i</sub> for the different types of pluggable modules are listed in the following table:

Pluggable protection Module Types	U <sub>i</sub>
VSPC ... 5VDC EX	6 V
VSPC ... 12VDC EX	14 V
VSPC ... 12VAC EX	19 V
VSPC ... 24VDC EX	26 V
VSPC 1CL PW 24VAC EX	27 V
VSPC ... 24VAC EX	38 V
VSPC ... 48VAC EX	75 V

The temperature class / maximum surface temperature of the Base modules, depending on I and the ambient temperature range is listed in the following table:

Base Module Type	I	Ambient temperature range	Temperature class / Maximum surface temperature
VSPC BASE 4SL FG EX VSPC BASE 2CL FG EX VSPC BASE 1CL PW FG EX	250 mA	-40 to +60 °C	T6 / T85 °C
	250 mA	-40 to +75 °C	T5 / T100 °C
	350 mA	-40 to +85 °C	T4 / T135 °C
VSPC BASE 2CH FG EX	3,3 A	-40 to +60 °C	T6 / T85 °C
		-40 to +75 °C	T5 / T100 °C
		-40 to +85 °C	T4 / T135 °C

Page 1/2

# Approval – VSPC-IEC Ex



# Lightning and surge protection for low voltage facilities

<b>Lightning and surge protection for low voltage facilities</b>	Quick selection guide	C.2
	Type I and II lightning arrester	C.8
	Type I and II lightning arrester for use upstream of the electrical meter	C.12
	Type I and II lightning arrester for use downstream of the electrical meter	C.21
	Type I and II lightning arrester for use upstream of the electrical meter	C.25
	Type I and II lightning arrester for use downstream of the electrical meter	C.28
	Lightning arresters in industrial networks	C.35
	Type II surge protection	C.36
	Lightning and surge protection for photovoltaic systems on the DC side	C.58
	Type III surge protection for end devices	C.64



# Product quick selection, power supply

## Type I

Product	Version	Rated voltage Uc	Discharge capacity limp (10/350)	Protection level typ.	Follow current suppression capability I <sub>fi</sub>	blow-out/ encapsulated	Max. backup fuse A g/gG	Signalling contact	Overall width	Order No.
<b>Type I - LCF 50 kA</b>										
VPU I 1 R LCF 280V/50kA	1-pole	280 V	50 kA	1800 V	no follow current	encapsulated	250 A	1 CO	4 TE	1351230000
VPU I 1 LCF 280V/50kA	1-pole	280 V	50 kA	1800 V	no follow current	encapsulated	250 A		4 TE	1351250000
VPU I 1 R LCF 400V/50kA	1-pole	400 V	50 kA	2500 V	no follow current	encapsulated	250 A	1 CO	4 TE	1351280000
VPU I 1 LCF 400V/50kA	1-pole	400 V	50 kA	2500 V	no follow current	encapsulated	250 A		4 TE	1351300000
<b>Type I - LCF 35 kA</b>										
VPU I 1 R LCF 280V/35kA	1-pole	280 V	35 kA	1800 V	no follow current	encapsulated	250 A	1 CO	4 TE	1351330000
VPU I 1 LCF 280V/35kA	1-pole	280 V	35 kA	1800 V	no follow current	encapsulated	250 A		4 TE	1351350000
VPU I 1 R LCF 400V/35kA	1-pole	400 V	35 kA	2500 V	no follow current	encapsulated	250 A	1 CO	4 TE	1351380000
VPU I 1 LCF 400V/35kA	1-pole	400 V	35 kA	2500 V	no follow current	encapsulated	250 A		4 TE	1351400000
<b>Type I - LCF 25 kA / 280 V</b>										
VPU I 1 R LCF 280V/25kA	1-pole, separable	280 V	25 kA	1600 V	no follow current	encapsulated	250 A	1 CO	2 TE	1351570000
VPU I 1 LCF 280V/25kA	1-pole, separable	280 V	25 kA	1600 V	no follow current	encapsulated	250 A		2 TE	1351590000
VPU I 2 R LCF 280V/25kA	2-pole, separable	280 V	25 kA	1600 V	no follow current	encapsulated	250 A	1 CO	4 TE	1351620000
VPU I 2 LCF 280V/25kA	2-pole, separable	280 V	25 kA	1600 V	no follow current	encapsulated	250 A		4 TE	1351640000
VPU I 3 R LCF 280V/25kA	3-pole, separable	280 V	25 kA	1600 V	no follow current	encapsulated	250 A	1 CO	6 TE	1351670000
VPU I 3 LCF 280V/25kA	3-pole, separable	280 V	25 kA	1600 V	no follow current	encapsulated	250 A		6 TE	1351690000
VPU I 4 R LCF 280V/25kA	4-pole, separable	280 V	25 kA	1600 V	no follow current	encapsulated	250 A	1 CO	8 TE	1351720000
VPU I 4 LCF 280V/25kA	4-pole, separable	280 V	25 kA	1600 V	no follow current	encapsulated	250 A		8 TE	1351730000
VPU I 1+1R LCF 280V/25kA	2-pole, separable	280 V	25 kA	1600 V	no follow current	encapsulated	250 A	1 CO	4 TE	1351740000
VPU I 1+1 LCF 280V/25kA	2-pole, separable	280 V	25 kA	1600 V	no follow current	encapsulated	250 A		4 TE	1351750000
VPU I 3+1R LCF 280V/25kA	4-pole, separable	280 V	25 kA	1600 V	no follow current	encapsulated	250 A	1 CO	8 TE	1351770000
VPU I 3+1 LCF 280V/25kA	4-pole, separable	280 V	25 kA	1600 V	no follow current	encapsulated	250 A		8 TE	1351780000
<b>Type I - 25 kA / 400 V</b>										
VPU I 1 R 400V/25kA	1-pole, separable	400 V	25 kA	1900 V	no follow current	encapsulated	250 A	1 CO	2 TE	1351800000
VPU I 1 400V/25kA	1-pole, separable	400 V	25 kA	1900 V	no follow current	encapsulated	250 A		2 TE	1351820000
VPU I 1+1R 400V/25kA	2-pole, separable	400 V	25 kA	1900 V	no follow current	encapsulated	250 A	1 CO	4 TE	1351830000
VPU I 1+1 400V/25kA	2-pole, separable	400 V	25 kA	1900 V	no follow current	encapsulated	250 A		4 TE	1351840000
VPU I 3 R 400V/25kA	2-pole, separable	400 V	25 kA	1900 V	no follow current	encapsulated	250 A	1 CO	6 TE	1351850000
VPU I 3 400V/25kA	2-pole, separable	400 V	25 kA	1900 V	no follow current	encapsulated	250 A		6 TE	1351870000
VPU I 3+1R 400V/25kA	4-pole, separable	400 V	25 kA	1900 V	no follow current	encapsulated	250 A	1 CO	8 TE	1351880000
VPU I 3+1 400V/25kA	4-pole, separable	400 V	25 kA	1900 V	no follow current	encapsulated	250 A		8 TE	1351890000
<b>Type I - N-PE 50 kA / 100 kA</b>										
VPU I 1 N-PE 260V50kA	1-pole	260 V	50 kA	1500 V	no follow current	encapsulated	n. A.		1 TE	1351900000
VPU I 1 N-PE 260V100kA	1-pole	260 V	100 kA	1600 V	no follow current	encapsulated	n. A.		2 TE	1351920000
VPU I 1 N-PE 440V50kA	1-pole	440 V	50 kA	1500 V	no follow current	encapsulated	n. A.		1 TE	1351950000
VPU I 1 N-PE 440V100kA	1-pole	440 V	100 kA	1600 V	no follow current	encapsulated	n. A.		2 TE	1351970000
<b>Type I - LCF 12.5 kA</b>										
VPU I 3+1LCF 280V/12.5kA	4-pole, separable	280 V	12.5 kA	1450 V	no follow current	encapsulated	250 A		4 TE	1352020000
VPU I 3+1R LCF 280V/12.5kA	4-pole, separable	280 V	12.5 kA	1450 V	no follow current	encapsulated	250 A	1 CO	4 TE	1352030000
VPU I 1+1 LCF 280V/12.5kA	2-pole, separable	280 V	12.5 kA	1450 V	no follow current	encapsulated	250 A		2 TE	1352040000
VPU I 1+1R LCF 280V/12.5kA	2-pole, separable	280 V	12.5 kA	1450 V	no follow current	encapsulated	250 A	1 CO	2 TE	1352050000
VPU I 1 LCF 280V/12.5kA	1-pole, separable	280 V	12.5 kA	1450 V	no follow current	encapsulated	250 A		1 TE	1352070000
VPU I 1 R LCF 280V/12.5kA	1-pole, separable	280 V	12.5 kA	1450 V	no follow current	encapsulated	250 A	1 CO	1 TE	1352080000
VPU I 3 LCF 280V/12.5kA	2-pole, separable	280 V	12.5 kA	1450 V	no follow current	encapsulated	250 A		3 TE	1352090000
VPU I 3 R LCF 280V/12.5kA	2-pole, separable	280 V	12.5 kA	1450 V	no follow current	encapsulated	250 A	1 CO	3 TE	1352100000
<b>Type I - 12.5 kA / 280 V</b>										
VPU I 1 280V/12.5kA	1-pole, separable	280 V	12.5 kA	1400 V	no follow current	encapsulated	250 A		1 TE	1352130000
VPU I 1 R 280V/12.5kA	1-pole, separable	280 V	12.5 kA	1400 V	no follow current	encapsulated	250 A	1 CO	1 TE	1352140000
VPU I 2 280V/12.5kA	2-pole, separable	280 V	12.5 kA	1400 V	no follow current	encapsulated	250 A		2 TE	1352150000
VPU I 2 R 280V/12.5kA	2-pole, separable	280 V	12.5 kA	1400 V	no follow current	encapsulated	250 A	1 CO	2 TE	1352170000
VPU I 4 280V/12.5kA	4-pole, separable	280 V	12.5 kA	1400 V	no follow current	encapsulated	250 A		4 TE	1352180000
VPU I 4 R 280V/12.5kA	4-pole, separable	280 V	12.5 kA	1400 V	no follow current	encapsulated	250 A	1 CO	4 TE	1352190000
VPU I 3 280V/12.5kA	3-pole, separable	280 V	12.5 kA	1400 V	no follow current	encapsulated	250 A		3 TE	1352200000
VPU I 3 R 280V/12.5kA	3-pole, separable	280 V	12.5 kA	1400 V	no follow current	encapsulated	250 A	1 CO	3 TE	1352220000
VPU I 3+1 280V/12.5kA	4-pole, separable	280 V	12.5 kA	1400 V	no follow current	encapsulated	250 A		4 TE	1352230000
VPU I 3+1R 280V/12.5kA	4-pole, separable	280 V	12.5 kA	1400 V	no follow current	encapsulated	250 A	1 CO	4 TE	1352240000
VPU I 1+1 280V/12.5kA	2-pole, separable	280 V	12.5 kA	1400 V	no follow current	encapsulated	250 A		2 TE	1352250000
VPU I 1+1R 280V/12.5kA	2-pole, separable	280 V	12.5 kA	1400 V	no follow current	encapsulated	250 A	1 CO	2 TE	1352270000



## Type I

Product	Version	Rated voltage  Uc	Discharge capacity Iimp (10/350)	Protection level  typ.	Follow current suppression capability I <sub>fi</sub>	blow-out/ encapsulated	Max. backup fuse A gI/gG	Signalling contact	Overall width	Order No.
<b>Type I - 12.5 kA / 400 V</b>										
VPU I 1 400V/12.5kA	1-pole, separable	400 V	12.5 kA	1800 V	no follow current	encapsulated	250 A		1 TE	1352290000
VPU I 1 R 400V/12.5kA	1-pole, separable	400 V	12.5 kA	1800 V	no follow current	encapsulated	250 A	1 CO	1 TE	1352300000
VPU I 1+1 400V/12.5kA	2-pole, separable	400 V	12.5 kA	1800 V	no follow current	encapsulated	250 A		2 TE	1352320000
VPU I 1+1 R 400V/12.5kA	2-pole, separable	400 V	12.5 kA	1800 V	no follow current	encapsulated	250 A	1 CO	2 TE	1352330000
VPU I 3 400V/12.5kA	3-pole, separable	400 V	12.5 kA	1800 V	no follow current	encapsulated	250 A		3 TE	1352340000
VPU I 3 R 400V/12.5kA	3-pole, separable	400 V	12.5 kA	1800 V	no follow current	encapsulated	250 A	1 CO	3 TE	1352350000
VPU I 3+1 400V/12.5kA	4-pole, separable	400 V	12.5 kA	1800 V	no follow current	encapsulated	250 A		4 TE	1352370000
VPU I 3+1 R 400V/12.5kA	4-pole, separable	400 V	12.5 kA	1800 V	no follow current	encapsulated	250 A	1 CO	4 TE	1352380000

C



# Product quick selection, power supply

## Type II

Product	Version	Rated voltage Uc	Discharge capacity Iimp (10/350)	Protection level typ.	Follow current suppression capability I <sub>fi</sub>	blow-out/ encapsulated	Max. backup fuse A gI/gG	Signalling contact	Overall width	Order No.
<b>Type II - 75 V</b>										
VPU II 1 75V/30kA	1-pole, separable	75 V	30 kA	650 V	no follow current	encapsulated	125 A		1 TE	1352390000
VPU II 1 R 75V/30kA	1-pole, separable	75 V	30 kA	650 V	no follow current	encapsulated	125 A	1 CO	1 TE	1352420000
VPU II 2 75V/30kA	2-pole, separable	75 V	30 kA	650 V	no follow current	encapsulated	125 A		1 TE	1352430000
VPU II 2 R 75V/30kA	2-pole, separable	75 V	30 kA	650 V	no follow current	encapsulated	125 A	1 CO	1 TE	1352440000
<b>Type II - 150 V</b>										
VPU II 1 150V/40kA	1-pole, separable	150 V	40 kA	900 V	no follow current	encapsulated	125 A		1 TE	1352470000
VPU II 1 R 150V/40kA	1-pole, separable	150 V	40 kA	900 V	no follow current	encapsulated	125 A	1 CO	1 TE	1352480000
VPU II 2 150V/40kA	2-pole, separable	150 V	40 kA	900 V	no follow current	encapsulated	125 A		2 TE	1352490000
VPU II 2 R 150V/40kA	2-pole, separable	150 V	40 kA	900 V	no follow current	encapsulated	125 A	1 CO	2 TE	1352500000
VPU II 3 150V/40kA	3-pole, separable	150 V	40 kA	900 V	no follow current	encapsulated	125 A		3 TE	1352520000
VPU II 3 R 150V/40kA	3-pole, separable	150 V	40 kA	900 V	no follow current	encapsulated	125 A	1 CO	3 TE	1352530000
VPU II 4 150V/40kA	4-pole, separable	150 V	40 kA	900 V	no follow current	encapsulated	125 A		4 TE	1352540000
VPU II 4 R 150V/40kA	4-pole, separable	150 V	40 kA	900 V	no follow current	encapsulated	125 A	1 CO	4 TE	1352550000
<b>Type II - 280 V</b>										
VPU II 1 280V/40kA	1-pole, separable	280 V	40 kA	1550 V	no follow current	encapsulated	125 A		1 TE	1352580000
VPU II 1 R 280V/40kA	1-pole, separable	280 V	40 kA	1550 V	no follow current	encapsulated	125 A	1 CO	1 TE	1352590000
VPU II 2 280V/40kA	2-pole, separable	280 V	40 kA	1550 V	no follow current	encapsulated	125 A		2 TE	1352600000
VPU II 2 R 280V/40kA	2-pole, separable	280 V	40 kA	1550 V	no follow current	encapsulated	125 A	1 CO	2 TE	1352620000
VPU II 1+1 280V/40kA	2-pole, separable	280 V	40 kA	1550 V	no follow current	encapsulated	125 A	1 CO	2 TE	1352630000
VPU II 1+1 R 280V/40kA	2-pole, separable	280 V	40 kA	1550 V	no follow current	encapsulated	125 A	1 CO	2 TE	1352640000
VPU II 3+1 280V/40kA	4-pole, separable	280 V	40 kA	1550 V	no follow current	encapsulated	125 A		4 TE	1352650000
VPU II 3+1 R 280V/40kA	4-pole, separable	280 V	40 kA	1550 V	no follow current	encapsulated	125 A	1 CO	4 TE	1352670000
VPU II 4 280V/40kA	4-pole, separable	280 V	40 kA	1550 V	no follow current	encapsulated	125 A		4 TE	1352680000
VPU II 4 R 280V/40kA	4-pole, separable	280 V	40 kA	1550 V	no follow current	encapsulated	125 A	1 CO	4 TE	1352690000
VPU II 3 280V/40kA	3-pole, separable	280 V	40 kA	1550 V	no follow current	encapsulated	125 A		3 TE	1352700000
VPU II 3 R 280V/40kA	3-pole, separable	280 V	40 kA	1550 V	no follow current	encapsulated	125 A	1 CO	3 TE	1352720000
VPU II 1 LCF 280V/40kA	1-pole, separable	280 V	40 kA	1550 V	no follow current	encapsulated	125 A		1 TE	1352740000
VPU II 1 R LCF 280V/40kA	1-pole, separable	280 V	40 kA	1550 V	no follow current	encapsulated	125 A	1 CO	1 TE	1352750000
VPU II 4 LCF 280V/40kA	4-pole, separable	280 V	40 kA	1550 V	no follow current	encapsulated	125 A		4 TE	1352770000
VPU II 4 R LCF 280V/40kA	4-pole, separable	280 V	40 kA	1550 V	no follow current	encapsulated	125 A	1 CO	4 TE	1352780000
VPU II 3 LCF 280V/40kA	3-pole, separable	280 V	40 kA	1550 V	no follow current	encapsulated	125 A		3 TE	1352790000
VPU II 3 R LCF 280V/40kA	3-pole, separable	280 V	40 kA	1550 V	no follow current	encapsulated	125 A	1 CO	3 TE	1352800000
<b>Type II - 400 V</b>										
VPU II 1 400V/40kA	1-pole, separable	400 V	40 kA	2100 V	no follow current	encapsulated	125 A		1 TE	1352830000
VPU II 1 R 400V/40kA	1-pole, separable	400 V	40 kA	2100 V	no follow current	encapsulated	125 A	1 CO	1 TE	1352840000
VPU II 2 400V/40kA	2-pole, separable	400 V	40 kA	2100 V	no follow current	encapsulated	125 A		2 TE	1352850000
VPU II 2 R 400V/40kA	2-pole, separable	400 V	40 kA	2100 V	no follow current	encapsulated	125 A	1 CO	2 TE	1352870000
VPU II 3 400V/40kA	3-pole, separable	400 V	40 kA	2100 V	no follow current	encapsulated	125 A		3 TE	1352880000
VPU II 3 R 400V/40kA	3-pole, separable	400 V	40 kA	2100 V	no follow current	encapsulated	125 A	1 CO	3 TE	1352890000
VPU II 4 400V/40kA	4-pole, separable	400 V	40 kA	2100 V	no follow current	encapsulated	125 A		4 TE	1352900000
VPU II 4 R 400V/40kA	4-pole, separable	400 V	40 kA	2100 V	no follow current	encapsulated	125 A	1 CO	4 TE	1352920000
<b>Type II - 600 V</b>										
VPU II 1 600V/25kA	1-pole, separable	600 V	25 kA	2350 V	no follow current	encapsulated	125 A		1 TE	1352940000
VPU II 1 R 600V/25kA	1-pole, separable	600 V	25 kA	2350 V	no follow current	encapsulated	125 A	1 CO	1 TE	1352950000
VPU II 2 600V/25kA	2-pole, separable	600 V	25 kA	2350 V	no follow current	encapsulated	125 A		2 TE	1352970000
VPU II 2 R 600V/25kA	2-pole, separable	600 V	25 kA	2350 V	no follow current	encapsulated	125 A	1 CO	2 TE	1352980000
VPU II 3 600V/25kA	3-pole, separable	600 V	25 kA	2350 V	no follow current	encapsulated	125 A		3 TE	1352990000
VPU II 3 R 600V/25kA	3-pole, separable	600 V	25 kA	2350 V	no follow current	encapsulated	125 A	1 CO	3 TE	1353000000
VPU II 4 600V/25kA	4-pole, separable	600 V	25 kA	2350 V	no follow current	encapsulated	125 A		4 TE	1353020000
VPU II 4 R 600V/25kA	4-pole, separable	600 V	25 kA	2350 V	no follow current	encapsulated	125 A	1 CO	4 TE	1351020000
<b>Type II - 750 V</b>										
VPU II 1 750V / 25kA	1-pole, separable	750 V	25 kA	2600 V	no follow current	encapsulated	125 A		1 TE	1351040000
VPU II 1 R 750V / 25kA	1-pole, separable	750 V	25 kA	2600 V	no follow current	encapsulated	125 A	1 CO	1 TE	1351050000
VPU II 2 750V / 25kA	2-pole, separable	750 V	25 kA	2600 V	no follow current	encapsulated	125 A		2 TE	1351070000
VPU II 2 R 750V / 25kA	2-pole, separable	750 V	25 kA	2600 V	no follow current	encapsulated	125 A	1 CO	2 TE	1351080000
VPU II 3 750V / 25kA	3-pole, separable	750 V	25 kA	2600 V	no follow current	encapsulated	125 A		3 TE	1351090000
VPU II 3 R 750V / 25kA	3-pole, separable	750 V	25 kA	2600 V	no follow current	encapsulated	125 A	1 CO	3 TE	1351100000
VPU II 4 750V / 25kA	4-pole, separable	750 V	25 kA	2600 V	no follow current	encapsulated	125 A		4 TE	1351120000
VPU II 4 R 750V / 25kA	4-pole, separable	750 V	25 kA	2600 V	no follow current	encapsulated	125 A	1 CO	4 TE	1351130000



## Type II

Product	Version	Rated voltage	Discharge capacity	Protection level	Follow current suppression capability	blow-out/encapsulated	Max. backup fuse	Signalling contact	Overall width	Order No.
		U <sub>c</sub>	(10/350)	typ.	I <sub>fi</sub>		A gI/gG			
VPU II 3+1 750V / 40kA	4-pole, separable	750 V	25 kA	2600 V	no follow current	encapsulated	125 A		4 TE	1351140000
VPU II 3+1 R 750V / 40kA	4-pole, separable	750 V	25 kA	2600 V	no follow current	encapsulated	125 A	1 CO	4 TE	1351150000
<b>Type II - N-PE</b>										
VPU II 1 N-PE 260V/40kA	1-pole, separable	260 V	40 kA	1500 V	no follow current	encapsulated	n. A.		1 TE	1351170000

C



# Product quick selection, power supply

## Type III

Product	Version	Rated voltage  U <sub>c</sub>	Discharge capacity limp (10/350)	Protection level  typ.	Follow current suppression capability I <sub>fi</sub>	blow-out/ encapsulated	Max. backup fuse A gI/gG	Signalling contact	Overall width	Order No.
<b>Type III - TS 35</b>										
VPU III R 12V/4kV AC/DC	1-pole, separable	12 V	2 kA	980 V	no follow current	encapsulated	16 A	1 CO	1 TE	1351550000
VPU III R 24V/4kV AC/DC	1-pole, separable	24 V	2 kA	890 V	no follow current	encapsulated	16 A	1 CO	1 TE	1351580000
VPU III R 48V/4kV AC/DC	1-pole, separable	48 V	2 kA	950 V	no follow current	encapsulated	16 A	1 CO	1 TE	1351600000
VPU III R 120V/6kV AC/DC	1-pole, separable	120 V	3 kA	1750 V	no follow current	encapsulated	16 A	1 CO	1 TE	1351630000
VPU III R 230V/6kV AC	1-pole, separable	230 V	3 kA	1800 V	no follow current	encapsulated	16 A	1 CO	1 TE	1351650000
VPU III 3/280V AC	3-pole	230 V	4 kA	1800 V	no follow current	encapsulated	16 A	1 NC	3 TE	1393050000
<b>Type III - SO LD</b>										
VPU III SO LD	1-pole	24 V	1.5 kA	1500 V	no follow current	encapsulated	16 A			1351680000
VPU III SO LD+A	1-pole	24 V	1.5 kA	1500 V	no follow current	encapsulated	16 A			1351700000



# Product quick selection, power supply

## Lightning and surge protection for photovoltaic systems

Product	Version	Rated voltage  U <sub>c</sub>	Discharge capacity I <sub>imp</sub> (10/350)	Protection level  typ.	Follow current suppression capability I <sub>fi</sub>	blow-out/ encapsulated	Max. backup fuse A gI/gG	Signalling contact	Overall width	Order No.
<b>Typ I</b>										
VPU I 2+0 R PV 1000V DC	3-pole, separable	1000 V DC	12.5 kA	2600 V	no follow current	encapsulated	135 A	1 CO	6 TE	1351430000
VPU I 2+0 PV 1000V DC	3-pole, separable	1000 V DC	12.5 kA	2600 V	no follow current	encapsulated	135 A		6 TE	1351470000
VPU I 2+0 R PV 600V DC	3-pole, separable	600 V DC	12.5 kA	1800 V	no follow current	encapsulated	135 A	1 CO	6 TE	1351490000
VPU I 2+0 PV 600V DC	3-pole, separable	600 V DC	12.5 kA	1800 V	no follow current	encapsulated	135 A		6 TE	1351520000
<b>Typ II</b>										
VPU II 2 PV 1000V DC	2-pole, separable	1000 V DC	25 kA	2800 V	no follow current	encapsulated	135 A		2 TE	1351220000
VPU II 2 R PV 1000V DC	2-pole, separable	1000 V DC	25 kA	2800 V	no follow current	encapsulated	135 A	1 CO	2 TE	1351240000
VPU II 3 PV 1000V DC	3-pole, separable	1000 V DC	40 kA	4000 V	no follow current	encapsulated	135 A		3 TE	1351270000
VPU II 3 R PV 1000V DC	3-pole, separable	1000 V DC	40 kA	4000 V	no follow current	encapsulated	135 A	1 CO	3 TE	1351290000
VPU II 2 PV 600V DC	2-pole, separable	600 V DC	40 kA	2200 V	no follow current	encapsulated	135 A		2 TE	1351340000
VPU II 2 R PV 600V DC	2-pole, separable	600 V DC	40 kA	2200 V	no follow current	encapsulated	135 A	1 CO	2 TE	1351370000
VPU II 3 PV 1200V DC	2-pole, separable	1200 V DC	40 kA	2200 V	no follow current	encapsulated	135 A		2 TE	1351420000
VPU II 3 R PV 1200V DC	2-pole, separable	1200 V DC	40 kA	2200 V	no follow current	encapsulated	135 A	1 CO	2 TE	1351440000
VPU II 3 PV 1500V DC	2-pole, separable	1500 V DC	40 kA	5200 V	no follow current	encapsulated	135 A		2 TE	1351500000
VPU II 3 R PV 1500V DC	2-pole, separable	1500 V DC	40 kA	5200 V	no follow current	encapsulated	135 A	1 CO	2 TE	1351530000

C



# Type I

## Lightning / surge protection for type I with spark gaps and varistor technology: VPU I

Weidmüller's VPU I series offers type I surge protection featuring varistor technology with a leakage current capacity of 12.5 kA to 50 kA (10/350  $\mu$ s). The pluggable, self-monitoring surge arresters of up to 25 kA are optionally available as 1-, 2-, 3- or 4-pole versions – with or without a remote signalling contact. VPU II devices can be rotated through 180° and thereby simplify installation with cross-connection bridges to the RCD. Since the devices can rotate, PE connections can take the shortest routes possible.

### The advantages for you:

- Rotate 180° and remote signalling function
- Suitable for various types of mains voltages (TN/TT)
- Tested in compliance with IEC 61643-11 and EN 61643-11
- Convenient installation in sub-distribution boards and electrical cabinets
- Designed for use in buildings according to lightning protective level III/IV for 12.5 kA and I/II for 25 kA
- Very low residual voltage (<1.3 kV), thus also suitable as Type II surge protection

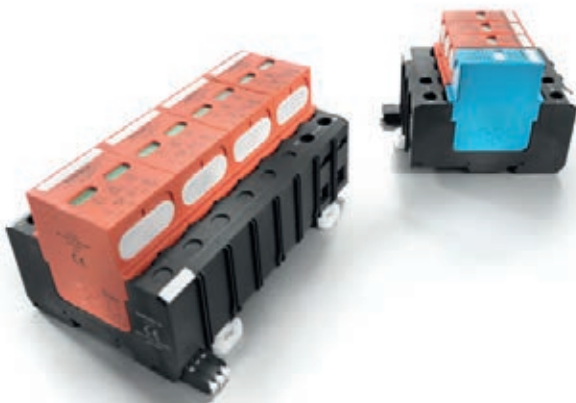

## Lightning conductors with spark gap for lightning protection or equipotential bonding providing Surge protection type I

According to the requirements of Type I (DIN VDE 0675 part 6) and Type I according to IEC 61643-11: the lightning arrester should be used in the transition zone between protective zones (LP) 0 and 1 (acc. to IEC 1312-1) for lightning protection equipotential bonding. In combination with several lightning protectors, the surge protection is used in the mains forms TN, TT and IT. When lightning strikes, the triggered air gap protector provides the necessary equipotential bonding between the building lightning protection and the earthing system of the power supply.

### VPU I LCF 30 kA and 50 kA

#### Lightning and surge protection for installation before the electric meter in the highest lightning protection level (LPL)

The VPU I LCF 30 kA and 50 kA line of lightning and surge protectors for power are installed before the meter. The arrester protects the low-voltage consumer and electronic devices from any direct lightning effects and couplings. VPU I LCF 30 kA and 50 kA are fully compliant with IEC 61643-11 and are approved according to type I and type II requirements and type 1 / type 2 as laid down in EN 61643-11. With this product line, Weidmüller provides type I surge protection in varistor gas discharge technology with a leakage current capacity of 30 kA and 50 kA (10/350  $\mu$ s), offering impressive freedom from leakage current and high protection properties. The VPU I LCF 12.5 kA is a "compact" solution for protective Types III/IV and is sufficient for use before the meter. With protection Type I, it is critical that this is used with one phase and the VPU I LCF 30 kA or 50 kA is the solution. When using two modules (L/N), the 50 kA required is attained in accordance with the requirements of various standards



### Electrical connection for building installation

The type 1 VPU I series lightning arrester is connected between the external conductors (L1, L2, L3) and N/PE. The N/PE spark gap is produced with the VPU I LCF N-PE 50 kA or 100 kA. Cables as short as possible should be used. The maximum permissible operating voltage UC is 280 V AC. Decoupling to downstream type II arresters is not necessary. Please note the installation instructions.

### Electrical connection for industrial installations

The PU 1 TSG+ 50 kA/330 V or 440 V type I lightning arrester is connected between the phase conductors (L1, L2, L3) and N/PE. A Weidmüller PU 1 TSG 50 kA is used to provide the N-PE sparkover gap. The lines for this should be kept as short as possible.

The triggered and blowout PU 1 TSG+ 50 kA devices can be clipped to TS 35 rails in electrical cabinets or distribution boards. Owing to the emissions given off when the sparkover gap is tripped, a safety clearance of min. 100 mm must be maintained between this and any current-conducting components. In addition, it must not be bolted directly to a mounting plate.

### Energy co-ordination

The maximum permissible operating voltage  $U_c$  is 330 or 440 V AC. Decoupling from downstream type II arresters is unnecessary because triggered sparkover gaps with a low sparkover voltage are used.

**Important:** for  $U_c$  330 V, PU II is used with 280 V and for  $U_c$  440 V, the PU II with 550 V.

Please follow the installation instructions.

### Checking operation, maintenance and approvals

All arresters based on varistor technology have large status windows. If the status window is red, the corresponding arrester must be changed. With the VPU I LCF 30 and 50 kA products, the entire unit must be replaced in the event of an error message or a red status window.

The "PU I TSG+" surge protection modules are checked by means of visual inspection. A function display, which lights up at 120 V AC and higher, a mains voltage failure and failure of the ignition electronics. Frequent checking is advisable during storms.

The triggered spark gaps result in a very low protection level of less than 1.5 kV with high leakage currents.

The connection is designed for the following cross-sections:

- solid wire: 10...16 mm<sup>2</sup>
- stranded wire: 10...50 mm<sup>2</sup>  
25 mm<sup>2</sup> for PU 1 TSG  
or PU I TSG+

The operating temperature range is -40 °C...+70 °C.



**Combination of spark gaps and varistor arrestors**

Unlike standard spark gaps, the Weidmüller spark gaps PU I TSG+ and PU 1 TSG feature electronic triggering. This ignites the spark gap sufficiently early so that the following arrester Type II (VPU-II series) is relieved. There is no need to decouple to downstream type II arresters because triggered spark gaps with a low activation voltage are used.

PU I TSG+ and PU 1 TSG differ in terms of secondary current discharge. The PU I TSG+ splits the arc voltage over several chambers. As soon as the total arc voltage exceeds the mains voltage available, the secondary current is discharged. With the PU 1 TSG, the secondary current is discharged in the next zero crossing of the mains voltage.

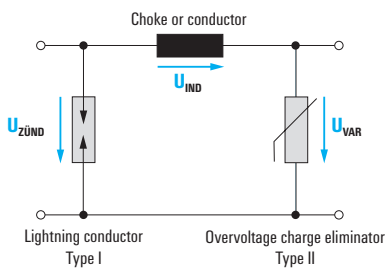

This used to be the usual solution, because the arresters were not co-ordinated.

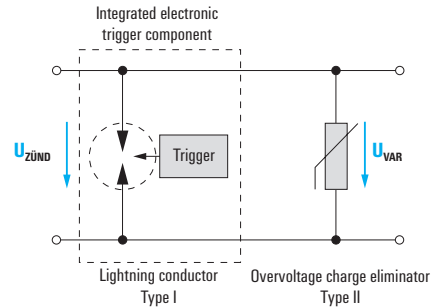

However, present day solutions no longer require restricting because they are co-ordinated with one another.



**Dimensional drawing VPU I**

Width: 17.5 mm (1 x TE)

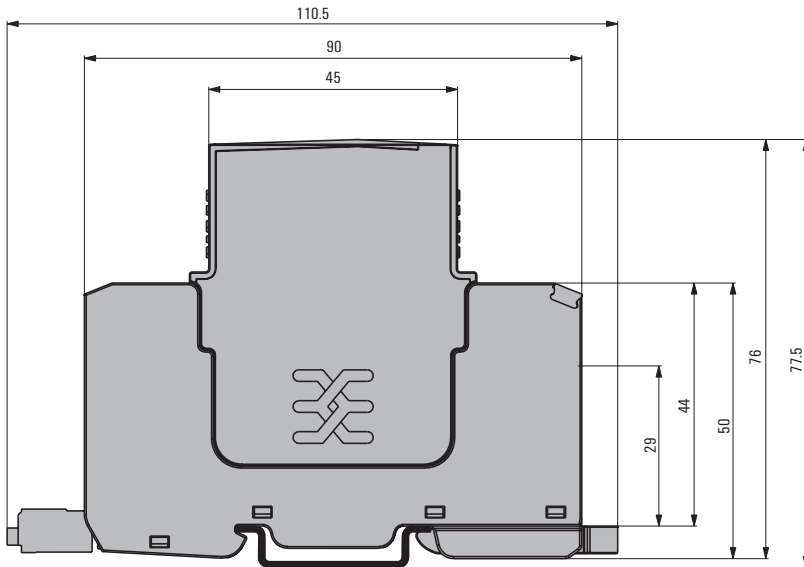

**Dimensional drawing PU I TSG+**

Width: 36 mm

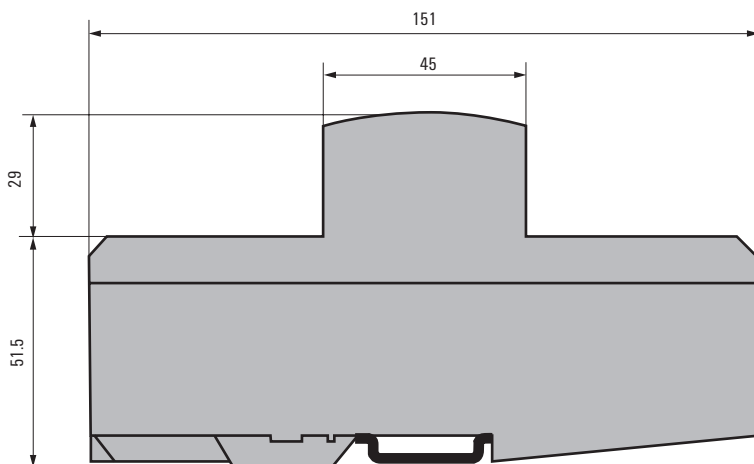

# VPU I lightning and surge protection

## Maximum type I protection from lightning and surges

With the increase in limit values in standards, the introduction of IEC/EN 61643-11 in 2012 places great emphasis on the need for all-round, reliable surge protection.

Our response to these new requirements is the new VPU lightning and surge protection series. Based on a combined varistor gas discharge technology, this forward-looking series of products is currently the first on the market to fulfil the new international standards and will therefore give your plant the highest protection.

However, you will not just be protecting your plant, but also your planning processes. Conformity with standards for at least 5 years means that you can minimise your planning iteration steps and the redesigns associated with them.

Many intelligent product features help installers during installation and maintenance specialists during their servicing of the lightning and surge protection system.

Equipped in this way, the VPU series provides a long-lasting, safe and forward-looking lightning and surge protection solution for your plant. See for yourself.

### Solutions for PV photovoltaics

VPU I variants can be used in photovoltaic systems in accordance with IEC 50539-11.

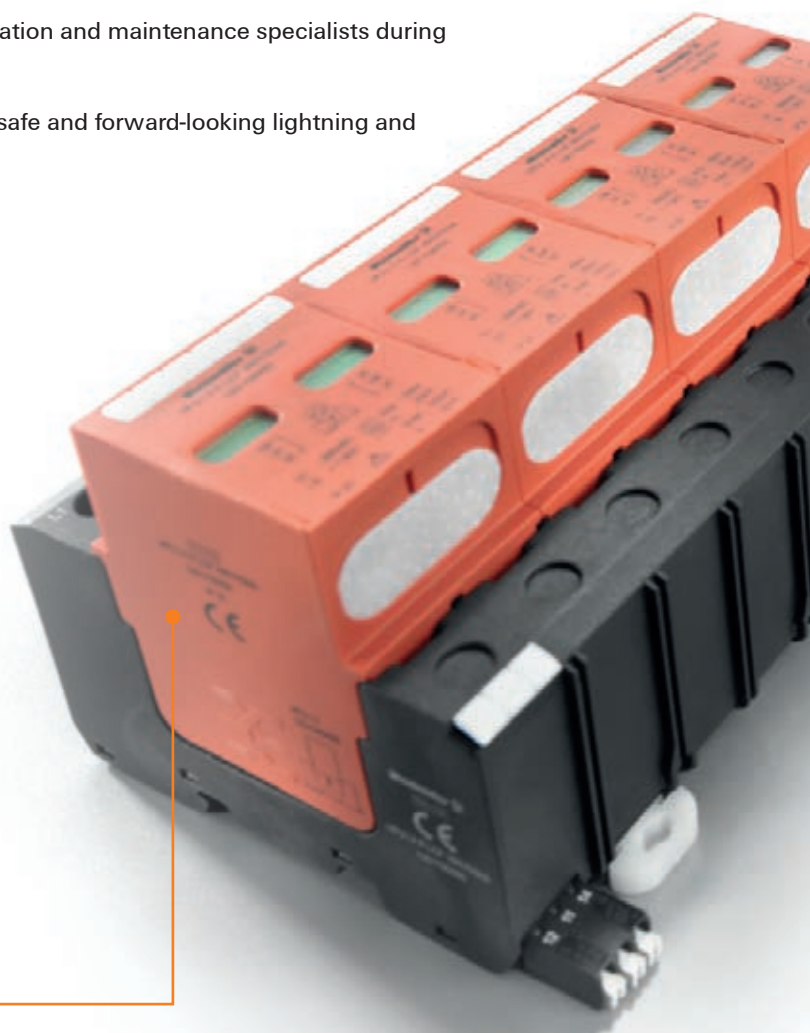

### Flexible positioning in the control cabinet

According to IEC 62305, the line path from the surge protection module to the PE connection may only be 50 cm. The fact that you can rotate the base through 180° means that you have the highest degree of flexibility during installation, without impacting on overall visibility.

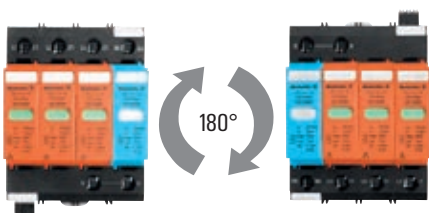

**Rapid status messaging**

The remote signaling contact with PUSH IN connection can be quickly connected and provides reliable information on the status of the protective function.



**Best overview**

The large, central, status window provides highly visible information on the status of the protective function.

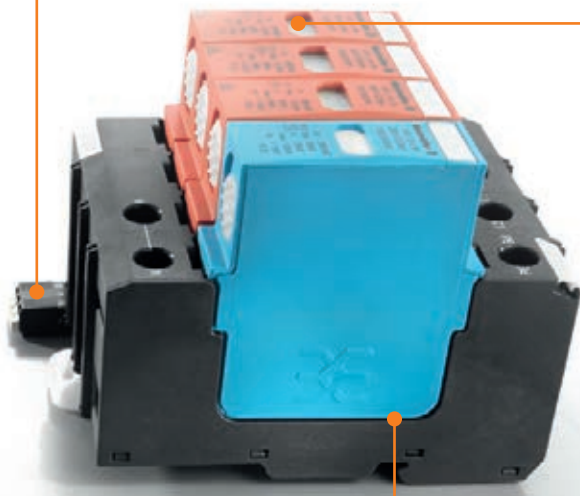

**Firmly locked in position**

You can hear and feel the arrester lock into the base. This enables it to comply with the exacting requirements on vibration resistance set by wind turbine plant manufacturers.



**Faster to assemble**

The optimised mounting rail clip enables easy and quick assembly and removal, without the need for tools.





## Type I and II lightning arrester for use upstream of the electrical meter

### Type I and II lightning arrester

- No-leakage-current version suitable for use upstream of the electrical meter
- Suitable with 35 kA or 50 kA (10/350 μs) for lightning protection level I, II, III and IV (LPL I/II/III/IV)
- Tested according to IEC 61643-11 for Type I and II surge protection
- Can also be used as Type II surge protection

### VPU I 1/R LCF 280 V / 50 kA

1-phase

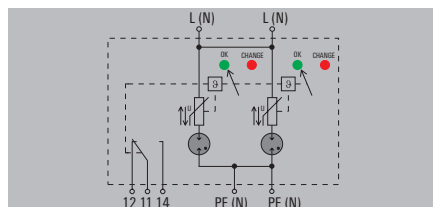

### VPU I 1/R LCF 400 V / 50 kA

1-phase

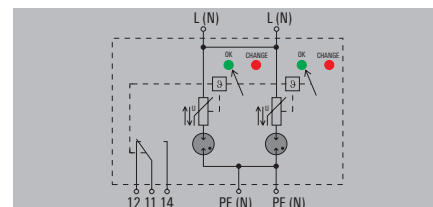

### Technical data

Rated voltage (AC)  
 Highest continuous current (AC)  
 Temporary surge voltage (over-voltage) - TOV  
 Requirements category acc. to IEC 61643-11  
 Lightning test current  $I_{imp}$  (10/350 μs)  
 Discharge current  $I_a$  (8/20μs) wire-wire  
 Discharge current  $I_{max}$  (8/20μs) wire-PE  
 Short-circuit resistance  $I_{SCCR}$   
 Total discharge current  $I_{total}$   
 Rated load current  $I_L$   
 PE conductor current  $I_{PE}$   
 Short-circuit strength with max. back-up fuse  
 Sparkover time / Drop-out time  
 Fusing  
 Protection level  $U_p$  (typical)  
 Optical function display  
 Design  
 Colour  
 Ambient temperature (operational)

#### Connection according to IEC 947-7-1

Solid  
 Stranded  
 Stripping length  
 Tightening torque

#### Approvals

Approvals  
 Standards

230 V  
 280 V  
 335 V  
 Type I, Type II  
 50 kA  
 25 kA  
 100 kA  
 25 kA  
 50 kA  
 125 A  
 0 μA  
 25 kA<sub>eff</sub>  
 ≤ 100 ns  
 315 A gl  
 ≤ 2.5 kV  
 green = OK; red = arrester is defective - replace  
 Installation housing; 4TE, Insta IP 20  
 Black  
 -40 °C...+70 °C

4...16 mm<sup>2</sup>  
 2.5...50 mm<sup>2</sup>  
 15 mm  
 2...3 Nm

IEC61643-11, EN61643-11

400 V  
 440 V  
 620 V  
 Type I, Type II  
 50 kA  
 25 kA  
 100 kA  
 25 kA  
 50 kA  
 125 A  
 0 μA  
 25 kA<sub>eff</sub>  
 ≤ 100 ns  
 315 A gl  
 ≤ 2.5 kV  
 green = OK; red = arrester is defective - replace  
 Installation housing; 4TE, Insta IP 20  
 Black  
 -40 °C...+70 °C

4...16 mm<sup>2</sup>  
 2.5...50 mm<sup>2</sup>  
 15 mm  
 2...3 Nm

IEC61643-11, EN61643-11

### Dimensions / Signalling contact info

Clamping range (nominal / min. / max.) mm<sup>2</sup>  
 Height x width x depth mm  
 Signalling contact

#### Note

### no remote sig. contact with remote signalling (R)

16 / 4 / 50  
 94 / 71.2 / 69  
 No  
 250 V 1A 1CO

### no remote sig. contact with remote signalling (R)

16 / 4 / 50  
 94 / 71.2 / 69  
 No  
 250 V 1A 1CO

### Ordering data

no remote sig. contact  
 with remote signalling (R)

Type	Qty.	Order No.
VPU I 1 LCF 280V/50KA	1	1351250000
VPU I 1 R LCF 280V/50KA	1	1351230000

Type	Qty.	Order No.
VPU I 1 LCF 400V/50KA	1	1351300000
VPU I 1 R LCF 400V/50KA	1	1351280000

#### Note

### Accessories

#### Note

**Type I and II lightning arrester**

- No-leakage-current version suitable for use upstream of the electrical meter
- Suitable with 35 kA or 50 kA (10/350 μs) for lightning protection level I, II, III and IV (LPL I/II/III/IV)
- Tested according to IEC 61643-11 for Type I and II surge protection
- Can also be used as Type II surge protection

**VPU I 1/R LCF 280 V / 35 kA**

1-phase

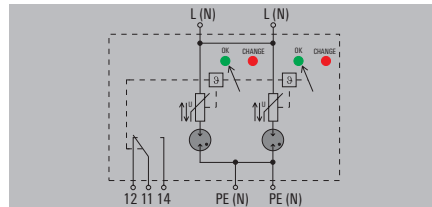

**VPU I 1/R LCF 400 V / 35 kA**

1-phase

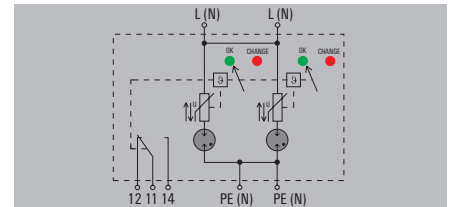

**Technical data**

Rated voltage (AC)	230 V
Highest continuous current (AC)	280 V
Temporary surge voltage (over-voltage) - TOV	335 V
Requirements category acc. to IEC 61643-11	Type I, Type II
Lightning test current $I_{imp}$ (10/350 μs)	35 kA
Discharge current $I_a$ (8/20μs) wire-wire	25 kA
Discharge current $I_{max}$ (8/20μs) wire-PE	100 kA
Short-circuit resistance $I_{SCCR}$	25 kA
Total discharge current $I_{total}$	35 kA
Rated load current $I_L$	125 A
PE conductor current $I_{PE}$	0 μA
Short-circuit strength with max. back-up fuse	25 kA <sub>eff</sub>
Sparkover time / Drop-out time	≤ 100 ns
Fusing	315 A gl
Protection level $U_p$ (typical)	≤ 2.5 kV
Optical function display	green = OK; red = arrester is defective - replace
Design	Installation housing; 4TE, Insta IP 20
Colour	Black
Ambient temperature (operational)	-40 °C...+70 °C
<b>Connection according to IEC 947-7-1</b>	
Solid	4...16 mm <sup>2</sup>
Stranded	2.5...50 mm <sup>2</sup>
Stripping length	15 mm
Tightening torque	2...3 Nm
<b>Approvals</b>	
Approvals	
Standards	IEC61643-11, EN61643-11

Rated voltage (AC)	400 V
Highest continuous current (AC)	440 V
Temporary surge voltage (over-voltage) - TOV	620 V
Requirements category acc. to IEC 61643-11	Type I, Type II
Lightning test current $I_{imp}$ (10/350 μs)	35 kA
Discharge current $I_a$ (8/20μs) wire-wire	25 kA
Discharge current $I_{max}$ (8/20μs) wire-PE	100 kA
Short-circuit resistance $I_{SCCR}$	25 kA
Total discharge current $I_{total}$	35 kA
Rated load current $I_L$	125 A
PE conductor current $I_{PE}$	0 μA
Short-circuit strength with max. back-up fuse	25 kA <sub>eff</sub>
Sparkover time / Drop-out time	≤ 100 ns
Fusing	315 A gl
Protection level $U_p$ (typical)	≤ 2.5 kV
Optical function display	green = OK; red = arrester is defective - replace
Design	Installation housing; 4TE, Insta IP 20
Colour	Black
Ambient temperature (operational)	-40 °C...+70 °C
<b>Connection according to IEC 947-7-1</b>	
Solid	4...16 mm <sup>2</sup>
Stranded	2.5...50 mm <sup>2</sup>
Stripping length	15 mm
Tightening torque	2...3 Nm
<b>Approvals</b>	
Approvals	
Standards	IEC61643-11, EN61643-11

<b>Dimensions / Signalling contact info</b>		
Clamping range (nominal / min. / max.)	mm <sup>2</sup>	
Height x width x depth	mm	
Signalling contact		
<b>Note</b>		
no remote sig. contact		
with remote signalling (R)		
<b>Ordering data</b>		
Type	Qty.	Order No.
VPU I 1 LCF 280V/35KA	1	1351350000
VPU I 1 R LCF 280V/35KA	1	1351330000
<b>Note</b>		
<b>Accessories</b>		
<b>Note</b>		

<b>Dimensions / Signalling contact info</b>		
Clamping range (nominal / min. / max.)	mm <sup>2</sup>	
Height x width x depth	mm	
Signalling contact		
<b>Note</b>		
no remote sig. contact		
with remote signalling (R)		
<b>Ordering data</b>		
Type	Qty.	Order No.
VPU I 1 LCF 400V/35KA	1	1351400000
VPU I 1 R LCF 400V/35KA	1	1351380000
<b>Note</b>		
<b>Accessories</b>		
<b>Note</b>		

<b>Dimensions / Signalling contact info</b>		
Clamping range (nominal / min. / max.)	mm <sup>2</sup>	
Height x width x depth	mm	
Signalling contact		
<b>Note</b>		
no remote sig. contact		
with remote signalling (R)		
<b>Ordering data</b>		
Type	Qty.	Order No.
VPU I 1 LCF 280V/35KA	1	1351350000
VPU I 1 R LCF 280V/35KA	1	1351330000
<b>Note</b>		
<b>Accessories</b>		
<b>Note</b>		

<b>Dimensions / Signalling contact info</b>		
Clamping range (nominal / min. / max.)	mm <sup>2</sup>	
Height x width x depth	mm	
Signalling contact		
<b>Note</b>		
no remote sig. contact		
with remote signalling (R)		
<b>Ordering data</b>		
Type	Qty.	Order No.
VPU I 1 LCF 400V/35KA	1	1351400000
VPU I 1 R LCF 400V/35KA	1	1351380000
<b>Note</b>		
<b>Accessories</b>		
<b>Note</b>		





## Type I and II lightning arrester for use upstream of the electrical meter

### Type I and II lightning arrester

- No-leakage-current version suitable for use upstream of the electrical meter
- Pluggable arrester
- Suitable with 25 kA (10/350 μs) for lightning protection level I, II, III and IV (LPL I/II/III/IV)
- Tested according to IEC 61643-11 for Type I and II surge protection
- Can also be used as Type II surge protection

### VPU I 3/R LCF 280 V / 25 kA

TN-C

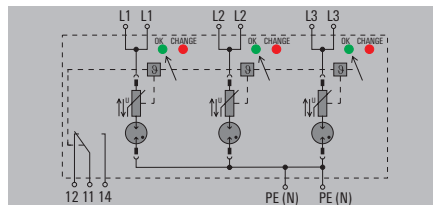

### VPU I 4/R LCF 280 V / 25 kA

TN-S

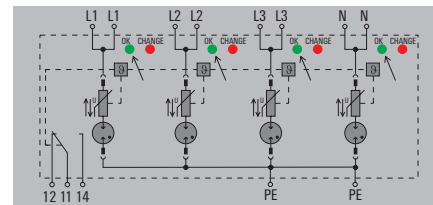

### Technical data

Rated voltage (AC)  
 Highest continuous current (AC)  
 Temporary surge voltage (over-voltage) - TOV  
 Requirements category acc. to IEC 61643-11  
 Lightning test current  $I_{imp}$  (10/350 μs)  
 Discharge current  $I_a$  (8/20μs) wire-wire  
 Discharge current  $I_{max}$  (8/20μs) wire-PE  
 Short-circuit resistance  $I_{SCCR}$   
 Total discharge current  $I_{total}$   
 Rated load current  $I_L$   
 PE conductor current  $I_{PE}$   
 Short-circuit strength with max. back-up fuse  
 Sparkover time / Drop-out time  
 Fusing  
 Protection level  $U_p$  (typical)  
 Optical function display  
 Design  
 Colour  
 Ambient temperature (operational)

#### Connection according to IEC 947-7-1

Solid  
 Stranded  
 Stripping length  
 Tightening torque

#### Approvals

Approvals  
 Standards

230 V  
 280 V  
 440 V  
 Type I, Type II  
 25 kA  
 25 kA  
 100 kA  
 25 kA  
 75 kA  
 125 A  
 0 μA  
 25 kA<sub>eff</sub>  
 ≤ 100 ns  
 250 A gL  
 ≤ 1.6 kV  
 green = OK; red = arrester is defective - replace  
 Installation housing; 6 TE, Insta IP 20  
 Black, Arrester red  
 -40 °C...+70 °C

2.5...16 mm<sup>2</sup>  
 2.5...50 mm<sup>2</sup>  
 15 mm  
 2...3 Nm

IEC61643-11, EN61643-11

230 V  
 280 V  
 335 V  
 Type I, Type II  
 25 kA  
 25 kA  
 100 kA  
 25 kA  
 100 kA  
 125 A  
 0 μA  
 25 kA<sub>eff</sub>  
 ≤ 100 ns  
 250 A gL  
 ≤ 1.6 kV  
 green = OK; red = arrester is defective - replace  
 Installation housing; 8 TE, Insta IP 20  
 Black, Arrester red  
 -40 °C...+70 °C

4...16 mm<sup>2</sup>  
 2.5...50 mm<sup>2</sup>  
 15 mm  
 2...3 Nm

IEC61643-11, EN61643-11

#### Dimensions / Signalling contact info

Clamping range (nominal / min. / max.) mm<sup>2</sup>  
 Height x width x depth mm  
 Signalling contact

#### Note

no remote sig. contact	with remote signalling (R)
16 / 2.5 / 50	16 / 2.5 / 50
94 / 108 / 69	106 / 108 / 69
No	250 V 1A 1CO

no remote sig. contact	with remote signalling (R)
16 / 4 / 50	16 / 2.5 / 50
90 / 144 / 69	106 / 144 / 69
No	250 V 1A 1CO

### Ordering data

no remote sig. contact  
 with remote signalling (R)

#### Note

Type	Qty.	Order No.
VPU I 3 LCF 280V/25KA	1	1351690000
VPU I 3 R LCF 280V/25KA	1	1351670000

Type	Qty.	Order No.
VPU I 4 LCF 280V/25KA	1	1351730000
VPU I 4 R LCF 280V/25KA	1	1351720000

### Accessories

#### Note

Pluggable spare arrester VPU I 0 LCF 280 V/25 kA-1351540000

Pluggable spare arrester VPU I 0 LCF 280 V/25 kA-1351540000

**Type I and II lightning arrester**

- No-leakage-current version suitable for use upstream of the electrical meter
- Pluggable arrester
- Suitable with 25 kA (10/350 μs) for lightning protection level I, II, III and IV (LPL I/II/III/IV)
- Tested according to IEC 61643-11 for Type I and II surge protection
- Can also be used as Type II surge protection

**VPU I 3+1/R LCF 280 V / 25 kA**

TN-S, TT

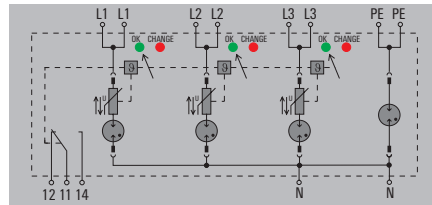

**VPU I 1+1/R LCF 280 V / 25 kA**

1-phase

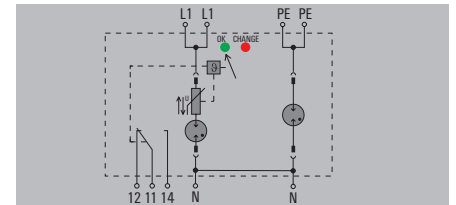

**Technical data**

Rated voltage (AC)  
 Highest continuous current (AC)  
 Temporary surge voltage (over-voltage) - TOV  
 Requirements category acc. to IEC 61643-11  
 Lightning test current  $I_{imp}$  (10/350 μs)  
 Discharge current  $I_a$  (8/20μs) wire-wire  
 Discharge current  $I_{max}$  (8/20μs) wire-PE  
 Short-circuit resistance  $I_{SCCR}$   
 Total discharge current  $I_{total}$   
 Rated load current  $I_L$   
 PE conductor current  $I_{PE}$   
 Short-circuit strength with max. back-up fuse  
 Sparkover time / Drop-out time  
 Fusing  
 Protection level  $U_p$  (typical)  
 Optical function display  
 Design  
 Colour  
 Ambient temperature (operational)

**Connection according to IEC 947-7-1**

Solid  
 Stranded  
 Stripping length  
 Tightening torque

**Approvals**

Approvals  
 Standards

230 V  
 280 V  
 440 V  
 Type I, Type II  
 25 kA  
 25 kA  
 100 kA  
 25 kA  
 100 kA  
 125 A  
 0 μA  
 25 kA<sub>eff</sub>  
 ≤ 100 ns  
 250 A gL  
 ≤ 1.6 kV  
 green = OK; red = arrester is defective - replace  
 Installation housing; 8 TE, Insta IP 20  
 Black, Arrester red / blue  
 -40 °C...+70 °C

2.5...16 mm<sup>2</sup>  
 2.5...50 mm<sup>2</sup>  
 15 mm  
 2...3 Nm

IEC61643-11, EN61643-11

230 V  
 280 V  
 440 V  
 Type I, Type II  
 25 kA  
 25 kA  
 100 kA  
 25 kA  
 50 kA  
 125 A  
 0 μA  
 25 kA<sub>eff</sub>  
 ≤ 100 ns  
 250 A gL  
 ≤ 1.6 kV  
 green = OK; red = arrester is defective - replace  
 Installation housing; 4TE, Insta IP 20  
 Black, Arrester red / blue  
 -40 °C...+70 °C

2.5...16 mm<sup>2</sup>  
 2.5...50 mm<sup>2</sup>  
 15 mm  
 2...3 Nm

IEC61643-11, EN61643-11

**Dimensions / Signalling contact info**

Clamping range (nominal / min. / max.) mm<sup>2</sup>  
 Height x width x depth mm  
 Signalling contact

**Note**

**no remote sig. contact      with remote signalling (R)**

16 / 2.5 / 50	16 / 2.5 / 50
94 / 144 / 69	106 / 144 / 69
No	250 V 1A 1CO

**no remote sig. contact      with remote signalling (R)**

16 / 2.5 / 50	16 / 2.5 / 50
94 / 72 / 69	106 / 72 / 69
No	250 V 1A 1CO

**Ordering data**

no remote sig. contact  
 with remote signalling (R)

Type	Qty.	Order No.
VPU I 3+1 LCF 280V/25KA	1	1351780000
VPU I 3+1RLCF 280V/25KA	1	1351770000

Type	Qty.	Order No.
VPU I 1+1 LCF 280V/25KA	1	1351750000
VPU I 1+1RLCF 280V/25KA	1	1351740000

**Note**

**Accessories**

**Note**

Pluggable spare arrester L-N VPU I 0 LCF 280 V/25 kA-1351540000;  
 N-PE VPU I 0 N-PE 260 V/100 kA-1351940000

Pluggable spare arrester L-N VPU I 0 LCF 280 V/25 kA-1351540000;  
 N-PE VPU I 0 N-PE 260 V/100 kA-1351940000





## Type I and II lightning arrester for use upstream of the electrical meter

### Type I and II lightning arrester

- No-leakage-current version suitable for use upstream of the electrical meter
- Pluggable arrester
- Suitable with 25 kA (10/350 μs) for lightning protection level I, II, III and IV (LPL I/II/III/IV)
- Tested according to IEC 61643-11 for Type I and II surge protection
- Can also be used as Type II surge protection

### VPU I 2/R LCF 280 V / 25 kA

1-phase

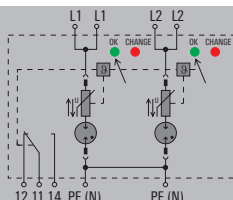

### VPU I 1/R LCF 280 V / 25 kA

1-phase

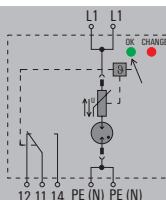

### Technical data

Rated voltage (AC)  
 Highest continuous current (AC)  
 Temporary surge voltage (over-voltage) - TOV  
 Requirements category acc. to IEC 61643-11  
 Lightning test current  $I_{imp}$  (10/350 μs)  
 Discharge current  $I_a$  (8/20 μs) wire-wire  
 Discharge current  $I_{max}$  (8/20 μs) wire-PE  
 Short-circuit resistance  $I_{SCCR}$   
 Total discharge current  $I_{total}$   
 Rated load current  $I_L$   
 PE conductor current  $I_{PE}$   
 Short-circuit strength with max. back-up fuse  
 Sparkover time / Drop-out time  
 Fusing  
 Protection level  $U_p$  (typical)  
 Optical function display  
 Design  
 Colour  
 Ambient temperature (operational)

#### Connection according to IEC 947-7-1

Solid  
 Stranded  
 Stripping length  
 Tightening torque

#### Approvals

Approvals  
 Standards

230 V  
 280 V  
 440 V  
 Type I, Type II  
 25 kA  
 25 kA  
 100 kA  
 25 kA  
 50 kA  
 125 A  
 0 μA  
 25 kA<sub>eff</sub>  
 ≤ 100 ns  
 250 A gL  
 ≤ 1.6 kV  
 green = OK; red = arrester is defective - replace  
 Installation housing; 4TE, Insta IP 20  
 Black, Arrester red  
 -40 °C...+70 °C

2.5...16 mm<sup>2</sup>  
 2.5...50 mm<sup>2</sup>  
 15 mm  
 2...3 Nm

IEC61643-11, EN61643-11

230 V  
 280 V  
 440 V  
 Type I, Type II  
 25 kA  
 25 kA  
 100 kA  
 25 kA  
 25 kA  
 125 A  
 0 μA  
 25 kA<sub>eff</sub>  
 ≤ 100 ns  
 250 A gL  
 ≤ 1.6 kV  
 green = OK; red = arrester is defective - replace  
 Installation housing; 2TE, Insta IP 20  
 Black, Arrester red  
 -40 °C...+70 °C

2.5...16 mm<sup>2</sup>  
 2.5...50 mm<sup>2</sup>  
 15 mm  
 2...3 Nm

IEC61643-11, EN61643-11

### Dimensions / Signalling contact info

Clamping range (nominal / min. / max.) mm<sup>2</sup>  
 Height x width x depth mm  
 Signalling contact

#### Note

### no remote sig. contact with remote signalling (R)

16 / 2.5 / 50  
 94 / 72 / 69  
 No

16 / 2.5 / 50  
 106 / 72 / 69  
 250 V 1A 1CO

### no remote sig. contact with remote signalling (R)

16 / 2.5 / 50  
 94 / 35.6 / 69  
 No

16 / 2.5 / 50  
 106 / 35.6 / 69  
 250 V 1A 1CO

### Ordering data

no remote sig. contact  
 with remote signalling (R)

Type	Qty.	Order No.
VPU I 2 LCF 280V/25KA	1	1351640000
VPU I 2 R LCF 280V/25KA	1	1351620000

Type	Qty.	Order No.
VPU I 1 LCF 280V/25KA	1	1351590000
VPU I 1 R LCF 280V/25KA	1	1351570000

#### Note

### Accessories

#### Note

Pluggable spare arrester VPU I 0 LCF 280 V/25 kA-1351540000

Pluggable spare arrester VPU I 0 LCF 280 V/25 kA-1351540000

### Type I lightning arrester

- This space-saving, encapsulated lightning arrester can switch mains follow currents and discharge currents of max. 50 kA (10/350 μs). It is possible to install in lightning protection level I and II.
- The pluggable arrester always guarantees proper readability. It also ensures that the shortest path is taken to the system's earth potential.
- The arrester's status display enables defective arresters to be quickly located and replaced.

### PU I 3+1 TSG+ 350 V 1.5 kV

TN-S, TT, IT

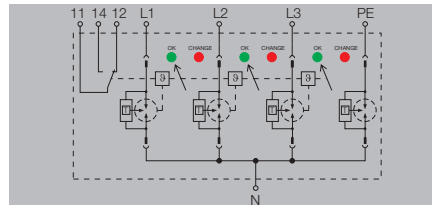

### PU I 3 TSG+ 350 V 1.5 kV

TN-C

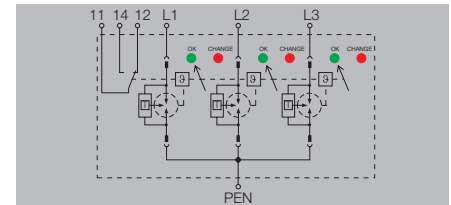

### Technical data

Rated voltage (AC)  
 Highest continuous current (AC)  
 Temporary surge voltage (over-voltage) - TOV  
 Requirements category acc. to IEC 61643-11  
 Lightning test current  $I_{imp}$  (10/350 μs)  
 Short-circuit resistance  $I_{SCCR}$   
 Total discharge current  $I_{total}$   
 Rated load current  $I_L$   
 PE conductor current  $I_{PE}$   
 Short-circuit strength with max. back-up fuse  
 Leakage current at  $U_N$   
 Sparkover time / Drop-out time  
 Fusing  
 Protection level  $U_p$  (typical)  
 Optical function display  
 Design  
 Colour  
 Ambient temperature (operational)

#### Connection according to IEC 947-7-1

Solid  
 Stranded  
 Stripping length  
 Tightening torque

#### Approvals

Approvals  
 Standards

240 V / 415 V  
 350 V  
 415 V  
 Type I  
 25 kA  
 150 kA  
 100 kA  
 125 A  
 5 μA  
 50 kA  
 0.01 mA  
 ≤ 100 ns  
 315 A gl  
 1500 V  
 green = OK; red = arrester is defective - replace  
 Installation housing: 8 TE, Insta IP 20  
 Black  
 -40 °C...+80 °C

2.5...25 mm<sup>2</sup>  
 2.5...25 mm<sup>2</sup>  
 18 mm  
 4...4.5 Nm

CE; cURus; GOSTME25  
 IEC61643-11, EN61643-11

240 V / 415 V  
 350 V  
 415 V  
 Type I  
 25 kA  
 150 kA  
 75 kA  
 125 A  
 5 μA  
 50 kA  
 0.01 mA  
 ≤ 100 ns  
 315 A gl  
 1500 V  
 green = OK; red = arrester is defective - replace  
 Installation housing: 6 TE, Insta IP 20  
 Black  
 -40 °C...+80 °C

2.5...25 mm<sup>2</sup>  
 2.5...25 mm<sup>2</sup>  
 18 mm  
 4...4.5 Nm

CE; cURus; GOSTME25  
 IEC61643-11, EN61643-11

### Dimensions / Signalling contact info

Clamping range (nominal / min. / max.) mm<sup>2</sup>  
 Height x width x depth mm  
 Signalling contact

#### Note

25 / 2.5 / 35  
 97 / 144 / 72.5  
 250 V 1A 1C0

25 / 2.5 / 35  
 97 / 108 / 72.5  
 250 V 1A 1C0

### Ordering data

Type	Qty.	Order No.
PU I 3+1TSG+ 350V 1,5kV	1	8960510000

#### Note

### Accessories

#### Note

Type	Qty.	Order No.
PU I 3+1TSG+ 350V 1,5kV	1	8960510000

Pluggable spare arrester: L-N: PU I 0 TSG+ 350V 1,5kV 8960520000  
 N-PE: PU I 0 N/PE TSG+ 350V 1,5kV 1066040000

Type	Qty.	Order No.
PU I 3TSG+ 350V 1,5kV	1	8960490000

Pluggable spare arrester: L-N: PU I 0 TSG+ 350V 1,5kV 8960520000  
 N-PE: PU I 0 N/PE TSG+ 350V 1,5kV 1066040000





## Type I and II lightning arrester for use upstream of the electrical meter

### Type I lightning arrester

- This space-saving, encapsulated lightning arrester can switch mains follow currents and discharge currents of max. 50 kA (10/350  $\mu$ s). It is possible to install in lightning protection level I and II.
- The pluggable arrester always guarantees proper readability. It also ensures that the shortest path is taken to the system's earth potential.
- The arrester's status display enables defective arresters to be quickly located and replaced.

### PU I 1+1 TSG+ 350 V 1.5 kV

1-phase

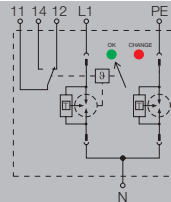

### PU I 1 TSG+ 350 V 1.5 kV

1-phase

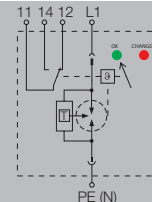

### Technical data

Rated voltage (AC)
Highest continuous current (AC)
Temporary surge voltage (over-voltage) - TOV
Requirements category acc. to IEC 61643-11
Lightning test current $I_{imp}$ (10/350 $\mu$ s)
Short-circuit resistance $I_{SCCR}$
Total discharge current $I_{total}$
Rated load current $I_L$
PE conductor current $I_{PE}$
Short-circuit strength with max. back-up fuse
Leakage current at $U_N$
Sparkover time / Drop-out time
Fusing
Protection level $U_p$ (typical)
Optical function display
Design
Colour
Ambient temperature (operational)

#### Connection according to IEC 947-7-1

Solid
Stranded
Stripping length
Tightening torque

#### Approvals

Approvals
Standards

240 V / 415 V
350 V
415 V
Type I
25 kA
150 kA
50 kA
125 A
5 $\mu$ A
50 kA
0.01 mA
$\leq 100$ ns
315 A gl
1500 V
green = OK; red = arrester is defective - replace
Installation housing; 4TE, Insta IP 20
Black
-40 °C...+80 °C

2.5...25 mm <sup>2</sup>
2.5...25 mm <sup>2</sup>
18 mm
4...4.5 Nm

CE; cURus; GOSTME25
IEC61643-11, EN61643-11

240 V
350 V
415 V
Type I
25 kA
150 kA
25 kA
125 A
5 $\mu$ A
50 kA
0.01 mA
$\leq 100$ ns
315 A gl
1500 V
green = OK; red = arrester is defective - replace
Installation housing; 2TE, Insta IP 20
Black
-40 °C...+80 °C

2.5...25 mm <sup>2</sup>
2.5...25 mm <sup>2</sup>
18 mm
4...4.5 Nm

CE; cURus; GOSTME25
IEC61643-11, EN61643-11

### Dimensions / Signalling contact info

Clamping range (nominal / min. / max.)	mm <sup>2</sup>
Height x width x depth	mm
Signalling contact	

#### Note

25 / 2.5 / 35
97 / 72 / 72.5
250 V 1A 1C0

25 / 2.5 / 35
97 / 36 / 72.5
250 V 1A 1C0

### Ordering data

--

Type	Qty.	Order No.
PU I 1+1TSG+ 350V 1,5kV	1	8960500000

Type	Qty.	Order No.
PU I 1TSG+ 350V 1,5kV	1	8960480000

#### Note

### Accessories

#### Note

Pluggable spare arrester: L-N: PU I 0 TSG+ 350V 1,5kV 8960520000  
N-PE: PU I 0 N/PE TSG+ 350V 1,5kV 1066040000

Pluggable spare arrester: L-N: PU I 0 TSG+ 350V 1,5kV 8960520000  
N-PE: PU I 0 N/PE TSG+ 350V 1,5kV 1066040000

**Type I and II lightning arrester**

- Suitable with 25 kA (10/350 µs) for lightning protection level I, II, III and IV (LPL I/II/III/IV)
- Pluggable arrester
- Tested according to IEC 61643-11 for Type I and II surge protection
- Can also be used as Type II surge protection
- Field of application downstream of the main electrical meter

**VPU I 3+1/R 400 V / 25 kA**

TN-S, TT, IT

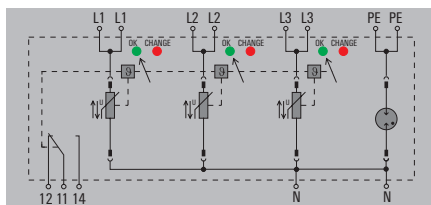

**VPU I 1+1/R 400 V / 25 kA**

1-phase

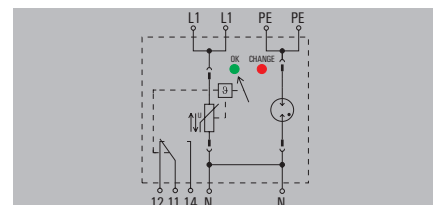

**Technical data**

Rated voltage (AC)  
 Highest continuous current (AC)  
 Temporary surge voltage (over-voltage) - TOV  
 Requirements category acc. to IEC 61643-11  
 Lightning test current  $I_{imp}$  (10/350 µs)  
 Discharge current  $I_a$  (8/20µs) wire-wire  
 Discharge current  $I_{max}$  (8/20µs) wire-PE  
 Short-circuit resistance  $I_{SCCR}$   
 Total discharge current  $I_{total}$   
 Rated load current  $I_L$   
 PE conductor current  $I_{PE}$   
 Short-circuit strength with max. back-up fuse  
 Sparkover time / Drop-out time  
 Fusing  
 Protection level  $U_p$  (typical)  
 Optical function display  
 Design  
 Colour  
 Ambient temperature (operational)

**Connection according to IEC 947-7-1**

Solid  
 Stranded  
 Stripping length  
 Tightening torque

**Approvals**

Approvals  
 Standards

400 V  
 440 V  
 620 V  
 Type I, Type II  
 25 kA  
 25 kA  
 100 kA  
 25 kA  
 50 kA  
 125 A  
 0 µA  
 25 kA<sub>eff</sub>  
 ≤ 25 ns  
 250 A gL  
 ≤ 1.9 kV  
 green = OK; red = arrester is defective - replace  
 Installation housing; 8 TE, Insta IP 20  
 Black, Arrester red / blue  
 -40 °C...+70 °C

4...16 mm<sup>2</sup>  
 2.5...50 mm<sup>2</sup>  
 15 mm  
 2...3 Nm

IEC61643-11, EN61643-11

400 V  
 440 V  
 620 V  
 Type I, Type II  
 25 kA  
 25 kA  
 100 kA  
 25 kA  
 50 kA  
 125 A  
 0 µA  
 25 kA<sub>eff</sub>  
 ≤ 25 ns  
 250 A gL  
 ≤ 1.9 kV  
 green = OK; red = arrester is defective - replace  
 Installation housing; 2TE, Insta IP 20  
 Black, Arrester red / blue  
 -40 °C...+70 °C

4...16 mm<sup>2</sup>  
 2.5...50 mm<sup>2</sup>  
 15 mm  
 2...3 Nm

IEC61643-11, EN61643-11

**Dimensions / Signalling contact info**

Clamping range (nominal / min. / max.) mm<sup>2</sup>  
 Height x width x depth mm  
 Signalling contact

**Note**

**no remote sig. contact      with remote signalling (R)**

16 / 4 / 50      16 / 4 / 50  
 94 / 142.4 / 69      106 / 142.4 / 69  
 No      250 V 1A 1CO

**no remote sig. contact      with remote signalling (R)**

16 / 4 / 50      16 / 4 / 50  
 94 / 35.6 / 69      106 / 35.6 / 69  
 No      250 V 1A 1CO

**Ordering data**

no remote sig. contact  
 with remote signalling (R)

Type	Qty.	Order No.
VPU I 3+1 400V/25KA	1	1351890000
VPU I 3+1R 400V/25KA	1	1351880000

Type	Qty.	Order No.
VPU I 1+1 400V/25KA	1	1351840000
VPU I 1+1R 400V/25KA	1	1351830000

**Note**

**Accessories**

**Note**

Pluggable spare arrester L-N VPU I 0 280 V/25 kA-1351790000,  
 N-PE VPU I 0 440 V/100 kA-1351990000

Pluggable spare arrester L-N VPU I 0 280 V/25 kA-1351790000,  
 N-PE VPU I 0 N-PE 440 V/100 kA-1351990000





**Type I and II lightning arrester for use downstream of the electrical meter**

**Type I and II lightning arrester**

- Suitable with 25 kA (10/350 μs) for lightning protection level I, II, III and IV (LPL I/II/III/IV)
- Pluggable arrester
- Tested according to IEC 61643-11 for Type I and II surge protection
- Can also be used as Type II surge protection
- Field of application downstream of the main electrical meter

**VPU I 3/R 400 V / 25 kA**

TN-C

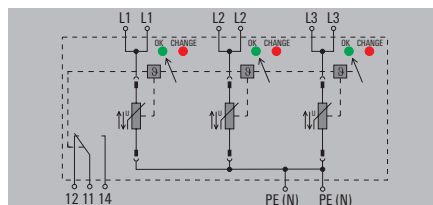

**VPU I 1/R 400 V / 25 kA**

1-phase

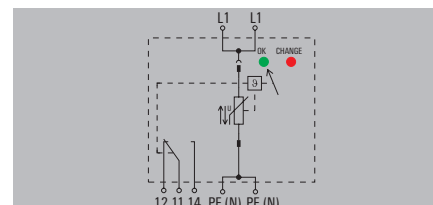

**Technical data**

Rated voltage (AC)  
 Highest continuous current (AC)  
 Temporary surge voltage (over-voltage) - TOV  
 Requirements category acc. to IEC 61643-11  
 Lightning test current  $I_{imp}$  (10/350 μs)  
 Discharge current  $I_a$  (8/20μs) wire-wire  
 Discharge current  $I_{max}$  (8/20μs) wire-PE  
 Short-circuit resistance  $I_{SCCR}$   
 Total discharge current  $I_{total}$   
 Rated load current  $I_L$   
 PE conductor current  $I_{PE}$   
 Short-circuit strength with max. back-up fuse  
 Sparkover time / Drop-out time  
 Fusing  
 Protection level  $U_p$  (typical)  
 Optical function display  
 Design  
 Colour  
 Ambient temperature (operational)

**Connection according to IEC 947-7-1**

Solid  
 Stranded  
 Stripping length  
 Tightening torque

**Approvals**

Approvals  
 Standards

400 V  
 440 V  
 620 V  
 Type I, Type II  
 25 kA  
 25 kA  
 100 kA  
 25 kA  
 75 kA  
 125 A  
 0 μA  
 25 kA<sub>eff</sub>  
 ≤ 25 ns  
 250 A gL  
 ≤ 1.9 kV  
 green = OK; red = arrester is defective - replace  
 Installation housing; 6 TE, Insta IP 20  
 Black, Arrester red  
 -40 °C...+70 °C

4...16 mm<sup>2</sup>  
 2.5...50 mm<sup>2</sup>  
 15 mm  
 2...3 Nm

IEC61643-11, EN61643-11

400 V  
 440 V  
 620 V  
 Type I, Type II  
 25 kA  
 25 kA  
 100 kA  
 25 kA  
 25 kA  
 125 A  
 0 μA  
 25 kA<sub>eff</sub>  
 ≤ 25 ns  
 250 A gL  
 ≤ 1.9 kV  
 green = OK; red = arrester is defective - replace  
 Installation housing; 2TE, Insta IP 20  
 Black, Arrester red  
 -40 °C...+70 °C

4...16 mm<sup>2</sup>  
 2.5...50 mm<sup>2</sup>  
 15 mm  
 2...3 Nm

IEC61643-11, EN61643-11

**Dimensions / Signalling contact info**

Clamping range (nominal / min. / max.) mm<sup>2</sup>  
 Height x width x depth mm  
 Signalling contact

**Note**

no remote sig. contact	with remote signalling (R)
16 / 4 / 50	16 / 4 / 50
94 / 106.8 / 69	106 / 106.8 / 69
No	250 V 1A 1CO

no remote sig. contact	with remote signalling (R)
16 / 4 / 50	16 / 4 / 50
94 / 35.6 / 69	106 / 35.6 / 69
No	250 V 1A 1CO

**Ordering data**

Type	Qty.	Order No.
VPU I 3 400V/25KA	1	1351870000
VPU I 3 R 400V/25KA	1	1351850000

**Note**

Type	Qty.	Order No.
VPU I 1 400V/25KA	1	1351820000
VPU I 1 R 400V/25KA	1	1351800000

**Accessories**

**Note** Pluggable spare arrester VPU I 0 400V/25kA-1351790000

**Note** Pluggable spare arrester VPU I 0 400V/25kA-1351790000

**Type I and II lightning arrester**

**N-PE path**

**Suitable for 230/400 V mains systems**

- Pluggable arrester
- High energy absorption with short time to sparkover
- Installation in distribution board

**VPU I 1 N-PE 260 V / 50 kA**

**N-PE arrester 260 V**

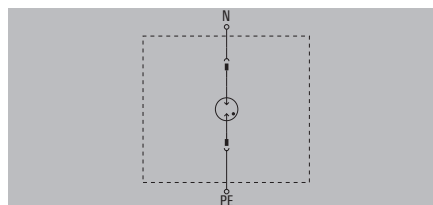

**VPU I 1 N-PE 260 V / 100 kA**

**N-PE arrester 260 V**

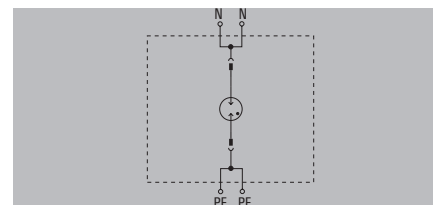

**Technical data**

Rated voltage (AC)	230 V
Highest continuous current (AC)	260 V
Temporary surge voltage (over-voltage) - TOV	1200 V
Requirements category acc. to IEC 61643-11	Type I, Type II
Lightning test current $I_{imp}$ (10/350 $\mu$ s)	50 kA
Discharge current $I_a$ (8/20 $\mu$ s) wire-wire	50 kA
Discharge current $I_{max}$ (8/20 $\mu$ s) wire-PE	50 kA
Total discharge current $I_{total}$	50 kA
Rated load current $I_l$	0 $\mu$ A
PE conductor current $I_{PE}$	$\leq 100$ ns
Sparkover time / Drop-out time	Not required
Fusing	Not required
Protection level $U_p$ (typical)	$\leq 1.5$ kV
Optical function display	No
Design	Installation housing; 1TE, Insta IP 20
Colour	Black, Arrester blue
Ambient temperature (operational)	-40 °C...+70 °C
<b>Connection according to IEC 947-7-1</b>	
Solid	2.5...16 mm <sup>2</sup>
Stranded	2.5...50 mm <sup>2</sup>
Stripping length	15 mm
Tightening torque	2...3 Nm
<b>Approvals</b>	
Approvals	IEC61643-11, EN61643-11
Standards	

Rated voltage (AC)	230 V
Highest continuous current (AC)	260 V
Temporary surge voltage (over-voltage) - TOV	1200 V
Requirements category acc. to IEC 61643-11	Type I, Type II
Lightning test current $I_{imp}$ (10/350 $\mu$ s)	100 kA
Discharge current $I_a$ (8/20 $\mu$ s) wire-wire	100 kA
Discharge current $I_{max}$ (8/20 $\mu$ s) wire-PE	100 kA
Total discharge current $I_{total}$	100 kA
Rated load current $I_l$	125 A
PE conductor current $I_{PE}$	0 $\mu$ A
Sparkover time / Drop-out time	$\leq 100$ ns
Fusing	Not required
Protection level $U_p$ (typical)	$\leq 2$ kV
Optical function display	No
Design	Installation housing; 2TE, Insta IP 20
Colour	Black, Arrester blue
Ambient temperature (operational)	-40 °C...+70 °C
<b>Connection according to IEC 947-7-1</b>	
Solid	2.5...16 mm <sup>2</sup>
Stranded	2.5...50 mm <sup>2</sup>
Stripping length	15 mm
Tightening torque	2...3 Nm
<b>Approvals</b>	
Approvals	IEC61643-11, EN61643-11
Standards	

Rated voltage (AC)	230 V
Highest continuous current (AC)	260 V
Temporary surge voltage (over-voltage) - TOV	1200 V
Requirements category acc. to IEC 61643-11	Type I, Type II
Lightning test current $I_{imp}$ (10/350 $\mu$ s)	100 kA
Discharge current $I_a$ (8/20 $\mu$ s) wire-wire	100 kA
Discharge current $I_{max}$ (8/20 $\mu$ s) wire-PE	100 kA
Total discharge current $I_{total}$	100 kA
Rated load current $I_l$	125 A
PE conductor current $I_{PE}$	0 $\mu$ A
Sparkover time / Drop-out time	$\leq 100$ ns
Fusing	Not required
Protection level $U_p$ (typical)	$\leq 2$ kV
Optical function display	No
Design	Installation housing; 2TE, Insta IP 20
Colour	Black, Arrester blue
Ambient temperature (operational)	-40 °C...+70 °C
<b>Connection according to IEC 947-7-1</b>	
Solid	2.5...16 mm <sup>2</sup>
Stranded	2.5...50 mm <sup>2</sup>
Stripping length	15 mm
Tightening torque	2...3 Nm
<b>Approvals</b>	
Approvals	IEC61643-11, EN61643-11
Standards	

<b>Dimensions / Signalling contact info</b>	
Clamping range (nominal / min. / max.)	mm <sup>2</sup>
Height x width x depth	mm
Signalling contact	
<b>Note</b>	

<b>no remote sig. contact</b>	
Clamping range (nominal / min. / max.)	16 / 2.5 / 50
Height x width x depth	94 / 17.8 / 69
Signalling contact	No
<b>Note</b>	

<b>no remote sig. contact</b>	
Clamping range (nominal / min. / max.)	16 / 2.5 / 50
Height x width x depth	94 / 35.6 / 69
Signalling contact	No
<b>Note</b>	

**Ordering data**

no remote sig. contact
------------------------

Type	Qty.	Order No.
VPU I 1 N-PE 260V/50KA	1	1351900000

Type	Qty.	Order No.
VPU I 1 N-PE 260V/100KA	1	1351920000

<b>Note</b>
-------------

--

--

**Accessories**

<b>Note</b>
-------------

Pluggable spare arrester VPU I 0 N-PE 260 V/50 kA-1351930000
--

Pluggable spare arrester VPU I 0 N-PE 260 V/100 kA-1351940000
---



**Type I and II lightning arrester**

**N-PE path**

**Suitable for 400/690 V mains systems**

- Tested according to IEC 61643-11 for Type I
- Pluggable arresters
- High energy absorption with short time to sparkover
- Installation in distribution board

**VPU I 1 N-PE 400 V / 50 kA**

**N-PE arrester 440 V**

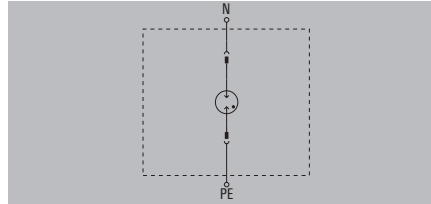

**VPU I 1 N-PE 400 V / 100 kA**

**N-PE arrester 440 V**

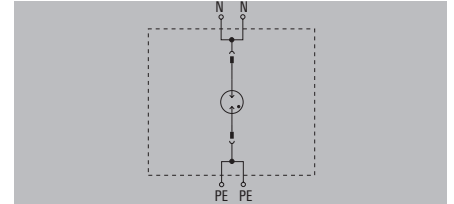

**Technical data**

Rated voltage (AC)	400 V
Highest continuous current (AC)	440 V
Temporary surge voltage (over-voltage) - TOV	1200 V
Requirements category acc. to IEC 61643-11	Type I, Type II
Lightning test current $I_{imp}$ (10/350 $\mu$ s)	50 kA
Discharge current $I_a$ (8/20 $\mu$ s) wire-wire	50 kA
Discharge current $I_{max}$ (8/20 $\mu$ s) wire-PE	50 kA
Total discharge current $I_{total}$	50 kA
Rated load current $I_n$	0 $\mu$ A
PE conductor current $I_{PE}$	$\leq 100$ ns
Sparkover time / Drop-out time	Not required
Fusing	$\leq 2$ kV
Protection level $U_p$ (typical)	No
Optical function display	No
Design	Installation housing; 1TE, Insta IP 20
Colour	Black, Arrester blue
Ambient temperature (operational)	-40 °C...+70 °C
<b>Connection according to IEC 947-7-1</b>	
Solid	2.5...16 mm <sup>2</sup>
Stranded	2.5...50 mm <sup>2</sup>
Stripping length	15 mm
Tightening torque	2...3 Nm
<b>Approvals</b>	
Approvals	IEC61643-11, EN61643-11
Standards	

Rated voltage (AC)	400 V
Highest continuous current (AC)	440 V
Temporary surge voltage (over-voltage) - TOV	1200 V
Requirements category acc. to IEC 61643-11	Type I, Type II
Lightning test current $I_{imp}$ (10/350 $\mu$ s)	100 kA
Discharge current $I_a$ (8/20 $\mu$ s) wire-wire	100 kA
Discharge current $I_{max}$ (8/20 $\mu$ s) wire-PE	100 kA
Total discharge current $I_{total}$	100 kA
Rated load current $I_n$	125 A
PE conductor current $I_{PE}$	0 $\mu$ A
Sparkover time / Drop-out time	$\leq 100$ ns
Fusing	Not required
Protection level $U_p$ (typical)	$\leq 2$ kV
Optical function display	No
Design	Installation housing; 2TE, Insta IP 20
Colour	Black, Arrester blue
Ambient temperature (operational)	-40 °C...+70 °C
<b>Connection according to IEC 947-7-1</b>	
Solid	2.5...16 mm <sup>2</sup>
Stranded	2.5...50 mm <sup>2</sup>
Stripping length	15 mm
Tightening torque	2...3 Nm
<b>Approvals</b>	
Approvals	IEC61643-11, EN61643-11
Standards	

Rated voltage (AC)	400 V
Highest continuous current (AC)	440 V
Temporary surge voltage (over-voltage) - TOV	1200 V
Requirements category acc. to IEC 61643-11	Type I, Type II
Lightning test current $I_{imp}$ (10/350 $\mu$ s)	100 kA
Discharge current $I_a$ (8/20 $\mu$ s) wire-wire	100 kA
Discharge current $I_{max}$ (8/20 $\mu$ s) wire-PE	100 kA
Total discharge current $I_{total}$	100 kA
Rated load current $I_n$	125 A
PE conductor current $I_{PE}$	0 $\mu$ A
Sparkover time / Drop-out time	$\leq 100$ ns
Fusing	Not required
Protection level $U_p$ (typical)	$\leq 2$ kV
Optical function display	No
Design	Installation housing; 2TE, Insta IP 20
Colour	Black, Arrester blue
Ambient temperature (operational)	-40 °C...+70 °C
<b>Connection according to IEC 947-7-1</b>	
Solid	2.5...16 mm <sup>2</sup>
Stranded	2.5...50 mm <sup>2</sup>
Stripping length	15 mm
Tightening torque	2...3 Nm
<b>Approvals</b>	
Approvals	IEC61643-11, EN61643-11
Standards	

<b>Dimensions / Signalling contact info</b>	
Clamping range (nominal / min. / max.)	mm <sup>2</sup>
Height x width x depth	mm
Signalling contact	No
<b>Note</b>	

<b>no remote sig. contact</b>	
Clamping range (nominal / min. / max.)	16 / 2.5 / 50
Height x width x depth	94 / 17.8 / 69
Signalling contact	No
<b>Note</b>	

<b>no remote sig. contact</b>	
Clamping range (nominal / min. / max.)	16 / 2.5 / 50
Height x width x depth	94 / 35.6 / 69
Signalling contact	No
<b>Note</b>	

**Ordering data**

no remote sig. contact
------------------------

Type	Qty.	Order No.
VPU I 1 N-PE 440V/50KA	1	1351950000

Type	Qty.	Order No.
VPU I 1 N-PE 440V/100KA	1	1351970000

<b>Note</b>
-------------

<b>Note</b>
-------------

<b>Note</b>
-------------

**Accessories**

<b>Note</b>
-------------

Pluggable spare arrester VPU I 0 N-PE 440 V/50 kA-1351980000
--

Pluggable spare arrester VPU I 0 N-PE 440 V/100 kA-1351990000
---



**Type I and II lightning arrester**

- No-leakage-current version suitable for use upstream of the electrical meter
- Pluggable arrester
- Suitable for lightning protection level III and IV (LPL III/IV)
- Tested according to IEC 61643-11 for Type I and II lightning and surge protection
- Can also be used as Type II surge protection

**VPU I 3+1/R LCF 280 V / 12.5 kA**

TN-S, TT

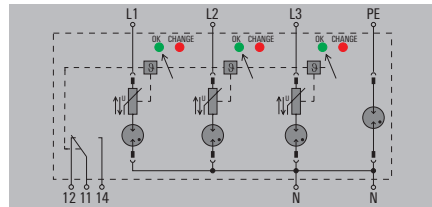

**VPU I 1+1/R LCF 280 V / 12.5 kA**

1-phase

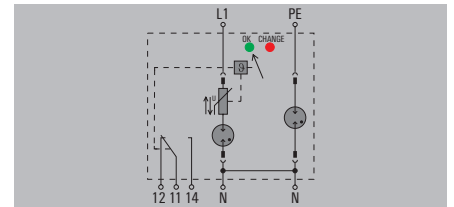

**Technical data**

Rated voltage (AC)	230 V
Highest continuous current (AC)	280 V
Temporary surge voltage (over-voltage) - TOV	335 V
Requirements category acc. to IEC 61643-11	Type I, Type II
Lightning test current $I_{imp}$ (10/350 $\mu$ s)	12.5 kA
Discharge current $I_a$ (8/20 $\mu$ s) wire-wire	25 kA
Discharge current $I_{max}$ (8/20 $\mu$ s) wire-PE	50 kA
Short-circuit resistance $I_{SCCR}$	25 kA
Total discharge current $I_{total}$	50 kA
PE conductor current $I_{PE}$	0 $\mu$ A
Short-circuit strength with max. back-up fuse	25 kA <sub>eff</sub>
Sparkover time / Drop-out time	$\leq 25$ ns, $\leq 100$ ns
Fusing	250 A gL
Protection level $U_p$ (typical)	$\leq 1.45$ kV
Optical function display	green = OK; red = arrester is defective - replace
Design	Installation housing: 4TE, Insta IP 20
Colour	Black, Arrester red / blue
Ambient temperature (operational)	-40 °C...+70 °C
<b>Connection according to IEC 947-7-1</b>	
Solid	4...16 mm <sup>2</sup>
Stranded	2.5...50 mm <sup>2</sup>
Stripping length	15 mm
Tightening torque	2...3 Nm
<b>Approvals</b>	
Approvals	
Standards	IEC61643-11, EN61643-11

Rated voltage (AC)	230 V
Highest continuous current (AC)	280 V
Temporary surge voltage (over-voltage) - TOV	335 V
Requirements category acc. to IEC 61643-11	Type I, Type II
Lightning test current $I_{imp}$ (10/350 $\mu$ s)	12.5 kA
Discharge current $I_a$ (8/20 $\mu$ s) wire-wire	25 kA
Discharge current $I_{max}$ (8/20 $\mu$ s) wire-PE	50 kA
Short-circuit resistance $I_{SCCR}$	25 kA
Total discharge current $I_{total}$	50 kA
PE conductor current $I_{PE}$	0 $\mu$ A
Short-circuit strength with max. back-up fuse	25 kA <sub>eff</sub>
Sparkover time / Drop-out time	$\leq 25$ ns, $\leq 100$ ns
Fusing	250 A gL
Protection level $U_p$ (typical)	$\leq 1.45$ kV
Optical function display	green = OK; red = arrester is defective - replace
Design	Installation housing: 2TE, Insta IP 20
Colour	Black, Arrester red / blue
Ambient temperature (operational)	-40 °C...+70 °C
<b>Connection according to IEC 947-7-1</b>	
Solid	4...16 mm <sup>2</sup>
Stranded	2.5...50 mm <sup>2</sup>
Stripping length	15 mm
Tightening torque	2...3 Nm
<b>Approvals</b>	
Approvals	
Standards	IEC61643-11, EN61643-11

Rated voltage (AC)	230 V
Highest continuous current (AC)	280 V
Temporary surge voltage (over-voltage) - TOV	335 V
Requirements category acc. to IEC 61643-11	Type I, Type II
Lightning test current $I_{imp}$ (10/350 $\mu$ s)	12.5 kA
Discharge current $I_a$ (8/20 $\mu$ s) wire-wire	25 kA
Discharge current $I_{max}$ (8/20 $\mu$ s) wire-PE	50 kA
Short-circuit resistance $I_{SCCR}$	25 kA
Total discharge current $I_{total}$	25 kA
PE conductor current $I_{PE}$	0 $\mu$ A
Short-circuit strength with max. back-up fuse	25 kA <sub>eff</sub>
Sparkover time / Drop-out time	$\leq 25$ ns, $\leq 100$ ns
Fusing	250 A gL
Protection level $U_p$ (typical)	$\leq 1.45$ kV
Optical function display	green = OK; red = arrester is defective - replace
Design	Installation housing: 2TE, Insta IP 20
Colour	Black, Arrester red / blue
Ambient temperature (operational)	-40 °C...+70 °C
<b>Connection according to IEC 947-7-1</b>	
Solid	4...16 mm <sup>2</sup>
Stranded	2.5...50 mm <sup>2</sup>
Stripping length	15 mm
Tightening torque	2...3 Nm
<b>Approvals</b>	
Approvals	
Standards	IEC61643-11, EN61643-11

Dimensions / Signalling contact info	
Clamping range (nominal / min. / max.)	mm <sup>2</sup>
Height x width x depth	mm
Signalling contact	
<b>Note</b>	

no remote sig. contact	with remote signalling (R)
16 / 4 / 50	16 / 4 / 50
94 / 71.2 / 69	106 / 53.4 / 69
No	250 V 1A 1CO
<b>Note</b>	

no remote sig. contact	with remote signalling (R)
16 / 4 / 50	16 / 4 / 50
94 / 35.6 / 69	106 / 35.6 / 69
No	250 V 1A 1CO
<b>Note</b>	

**Ordering data**

Type	Qty.	Order No.
VPU I 3+1LCF280V/12,5kA	1	1352020000
VPU I3+1RLCF280V/12,5KA	1	1352030000
<b>Note</b>		

Type	Qty.	Order No.
VPU I 1+1LCF280V/12,5KA	1	1352040000
VPU I1+1RLCF280V/12,5KA	1	1352050000
<b>Note</b>		

Type	Qty.	Order No.
VPU I 1+1LCF280V/12,5KA	1	1352040000
VPU I1+1RLCF280V/12,5KA	1	1352050000
<b>Note</b>		

**Accessories**

Pluggable spare arrester L-N VPU I 0 LCF 280 V/12.5 kA-1352000000, N-PE VPU I 0 N-PE 260 V/50 kA-1351930000
---

Pluggable spare arrester L-N VPU I 0 LCF 280 V/12.5 kA-1352000000, N-PE VPU I 0 N-PE 260 V/50 kA-1351930000
---

Pluggable spare arrester L-N VPU I 0 LCF 280 V/12.5 kA-1352000000, N-PE VPU I 0 N-PE 260 V/50 kA-1351930000
---





## Type I and II lightning arrester for use upstream of the electrical meter

### Type I and II lightning arrester

- No-leakage-current version suitable for use upstream of the electrical meter
- Pluggable arrester
- Suitable for lightning protection level III and IV (LPL III/IV)
- Tested according to IEC 61643-11 for Type I and II lightning and surge protection
- Can also be used as Type II surge protection

### VPU I 3/R LCF 280 V / 12.5 kA

TN-C

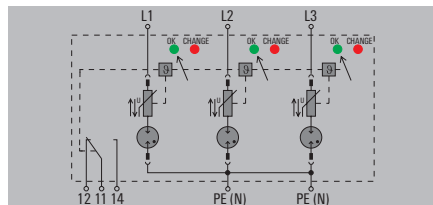

### VPU I 1/R LCF 280 V / 12.5 kA

1-phase

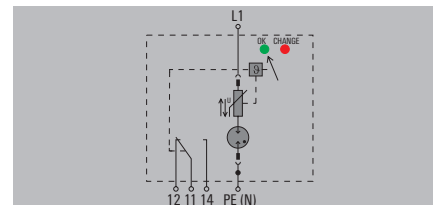

### Technical data

Rated voltage (AC)  
 Highest continuous current (AC)  
 Temporary surge voltage (over-voltage) - TOV  
 Requirements category acc. to IEC 61643-11  
 Lightning test current  $I_{imp}$  (10/350  $\mu$ s)  
 Discharge current  $I_a$  (8/20 $\mu$ s) wire-wire  
 Discharge current  $I_{max}$  (8/20 $\mu$ s) wire-PE  
 Short-circuit resistance  $I_{SCCR}$   
 Total discharge current  $I_{total}$   
 PE conductor current  $I_{PE}$   
 Short-circuit strength with max. back-up fuse  
 Sparkover time / Drop-out time  
 Fusing  
 Protection level  $U_p$  (typical)  
 Optical function display  
 Design  
 Colour  
 Ambient temperature (operational)

#### Connection according to IEC 947-7-1

Solid  
 Stranded  
 Stripping length  
 Tightening torque

#### Approvals

Approvals  
 Standards

230 V  
 280 V  
 335 V  
 Type I, Type II  
 12.5 kA  
 25 kA  
 50 kA  
 25 kA  
 37.5 kA  
 0  $\mu$ A  
 25 kA<sub>eff</sub>  
 $\leq 100$  ns  
 250 A gL  
 $\leq 1.45$  kV  
 green = OK; red = arrester is defective - replace  
 Installation housing; 3TE, Insta IP 20  
 Black, Arrester red  
 -40 °C...+70 °C

4...16 mm<sup>2</sup>  
 2.5...50 mm<sup>2</sup>  
 15 mm  
 2...3 Nm

IEC61643-11, EN61643-11

230 V  
 280 V  
 335 V  
 Type I, Type II  
 12.5 kA  
 25 kA  
 50 kA  
 25 kA  
 12.5 kA  
 0  $\mu$ A  
 25 kA<sub>eff</sub>  
 $\leq 100$  ns  
 250 A gL  
 $\leq 1.45$  kV  
 green = OK; red = arrester is defective - replace  
 Installation housing; 1TE, Insta IP 20  
 Black, Arrester red  
 -40 °C...+70 °C

4...16 mm<sup>2</sup>  
 2.5...50 mm<sup>2</sup>  
 15 mm  
 2...3 Nm

IEC61643-11, EN61643-11

### Dimensions / Signalling contact info

Clamping range (nominal / min. / max.) mm<sup>2</sup>  
 Height x width x depth mm  
 Signalling contact

#### Note

### with remote signalling (R) no remote sig. contact

16 / 4 / 50  
 106 / 53.4 / 69  
 250 V 1A 1CO  
 No

### with remote signalling (R) no remote sig. contact

16 / 4 / 50  
 106 / 17.8 / 69  
 250 V 1A 1CO  
 No

### Ordering data

with remote signalling (R)  
 no remote sig. contact

Type	Qty.	Order No.
VPU I 3RLCF 280V/12,5KA	1	1352100000
VPU I 3 LCF 280V/12,5KA	1	1352090000

Type	Qty.	Order No.
VPU I 1RLCF 280V/12,5KA	1	1352080000
VPU I 1 LCF 280V/12,5KA	1	1352070000

#### Note

### Accessories

#### Note

Pluggable spare arrester VPU I 0 280 V/12.5 kA-1352120000

Pluggable spare arrester VPU I 0 280 V/12.5 kA-1352120000



## VPU II surge protection

### Maximum type II protection from surges

With the increase in limit values in standards, the introduction of IEC/EN 61643-11 in 2012 places great emphasis on the need for all-round, reliable surge protection.

Our response to these new requirements is the new VPU lightning and surge protection series.

Based on a combined varistor gas discharge technology, this forward-looking series of products is currently the first on the market to fulfil the new international standards and will therefore give your plant the highest protection.

However, you will not just be protecting your plant, but also your planning processes. Conformity with standards for at least 5 years means that you can minimise your planning iteration steps and the redesigns associated with them.

Many intelligent product features help installers during installation and maintenance specialists during their servicing of the lightning and surge protection system.

Equipped in this way, the VPU series provides a long-lasting, safe and forward-looking lightning and surge protection solution for your plant. See for yourself.

#### Flexible positioning in the control cabinet

According to IEC 62305, the line path from the surge protection module to the PE connection may only be 50 cm. The fact that you can rotate the base through 180° means that you have the highest degree of flexibility during installation, without impacting on overall visibility.

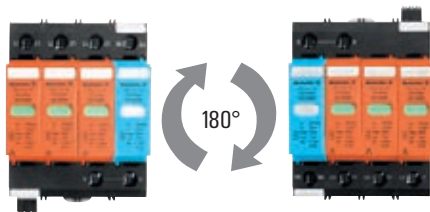

#### Faster to assemble

The optimised mounting rail clip enables easy and quick installation, without the need for tools.



**Solutions for PV photovoltaics**

VPU I variants can be used in photovoltaic systems in accordance with IEC 50569-11.

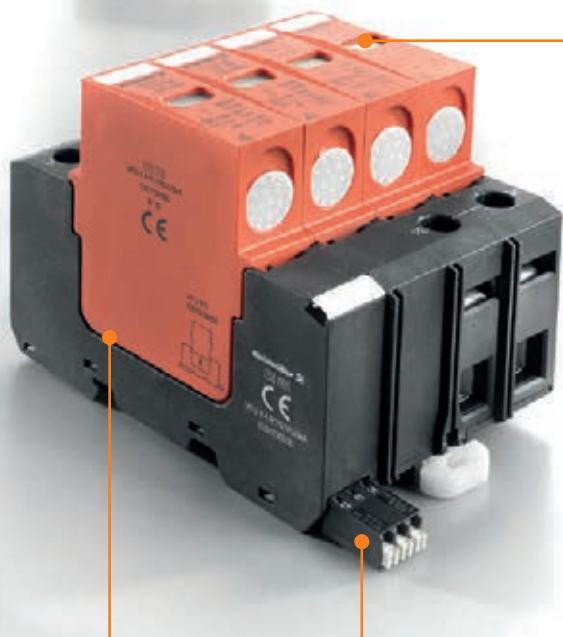

**Firmly locked in position**

You can hear and feel the arrester lock into the base. This enables it to comply with the exacting requirements on vibration resistance set by wind turbine plant manufacturers.



**Best overview**

The large, central, status window provides highly visible information on the status of the protective function.



**Rapid status messaging**

The remote signaling contact with PUSH IN connection can be quickly connected and provides reliable information on the status of the protective function.



**Type I and II lightning arrester for use downstream of electrical meter**

- Suitable for lightning protection level III and IV (LPL III/IV)
- Pluggable arresters
- Tested according to IEC 61643-11 for Type I and II lightning and surge protection

**VPU I 4/R 280 V / 12.5 kA**

TN-S

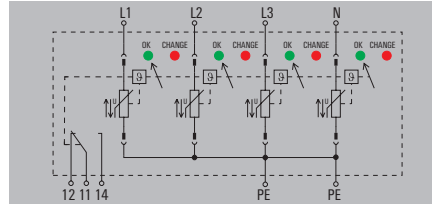

**VPU I 3/R 280 V / 12.5 kA**

TN-C

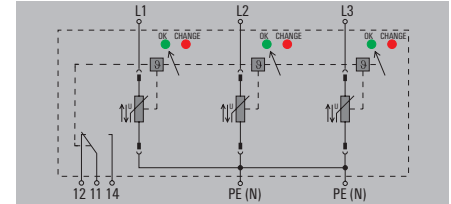

**Technical data**

Rated voltage (AC)	230 V
Highest continuous current (AC)	280 V
Temporary surge voltage (over-voltage) - TOV	335 V
Requirements category acc. to IEC 61643-11	Type I, Type II
Lightning test current $I_{imp}$ (10/350 $\mu$ s)	12.5 kA
Short-circuit strength with max. back-up fuse	25 kA <sub>eff</sub>
Discharge current $I_n$ (8/20 $\mu$ s) wire-wire	25 kA
Discharge current $I_{max}$ (8/20 $\mu$ s) wire-PE	50 kA
Short-circuit resistance $I_{SCCR}$	25 kA
Total discharge current $I_{total}$	50 kA
PE conductor current $I_{PE}$	30 $\mu$ A
Sparkover time / Drop-out time	$\leq 25$ ns
Fusing	250 A gL
Protection level $U_p$ (typical)	$\leq 1.4$ kV
Optical function display	green = OK; red = arrester is defective - replace
Design	Installation housing: 4TE, Insta IP 20
Colour	Black, Arrester red
Ambient temperature (operational)	-40 °C...+70 °C
<b>Connection according to IEC 947-7-1</b>	
Solid	4...16 mm <sup>2</sup>
Stranded	2.5...50 mm <sup>2</sup>
Stripping length	15 mm
Tightening torque	2...3 Nm
<b>Approvals</b>	
Approvals	
Standards	IEC61643-11, EN61643-11

Rated voltage (AC)	230 V
Highest continuous current (AC)	280 V
Temporary surge voltage (over-voltage) - TOV	335 V
Requirements category acc. to IEC 61643-11	Type I, Type II
Lightning test current $I_{imp}$ (10/350 $\mu$ s)	12.5 kA
Short-circuit strength with max. back-up fuse	25 kA <sub>eff</sub>
Discharge current $I_n$ (8/20 $\mu$ s) wire-wire	25 kA
Discharge current $I_{max}$ (8/20 $\mu$ s) wire-PE	50 kA
Short-circuit resistance $I_{SCCR}$	25 kA
Total discharge current $I_{total}$	50 kA
PE conductor current $I_{PE}$	30 $\mu$ A
Sparkover time / Drop-out time	$\leq 25$ ns
Fusing	250 A gL
Protection level $U_p$ (typical)	$\leq 1.4$ kV
Optical function display	green = OK; red = arrester is defective - replace
Design	Installation housing: 3TE, Insta IP 20
Colour	Black, Arrester red
Ambient temperature (operational)	-40 °C...+70 °C
<b>Connection according to IEC 947-7-1</b>	
Solid	4...16 mm <sup>2</sup>
Stranded	2.5...50 mm <sup>2</sup>
Stripping length	15 mm
Tightening torque	2...3 Nm
<b>Approvals</b>	
Approvals	
Standards	IEC61643-11, EN61643-11

Rated voltage (AC)	230 V
Highest continuous current (AC)	280 V
Temporary surge voltage (over-voltage) - TOV	335 V
Requirements category acc. to IEC 61643-11	Type I, Type II
Lightning test current $I_{imp}$ (10/350 $\mu$ s)	12.5 kA
Short-circuit strength with max. back-up fuse	25 kA <sub>eff</sub>
Discharge current $I_n$ (8/20 $\mu$ s) wire-wire	25 kA
Discharge current $I_{max}$ (8/20 $\mu$ s) wire-PE	50 kA
Short-circuit resistance $I_{SCCR}$	25 kA
Total discharge current $I_{total}$	37.5 kA
PE conductor current $I_{PE}$	30 $\mu$ A
Sparkover time / Drop-out time	$\leq 25$ ns
Fusing	250 A gL
Protection level $U_p$ (typical)	$\leq 1.4$ kV
Optical function display	green = OK; red = arrester is defective - replace
Design	Installation housing: 3TE, Insta IP 20
Colour	Black, Arrester red
Ambient temperature (operational)	-40 °C...+70 °C
<b>Connection according to IEC 947-7-1</b>	
Solid	4...16 mm <sup>2</sup>
Stranded	2.5...50 mm <sup>2</sup>
Stripping length	15 mm
Tightening torque	2...3 Nm
<b>Approvals</b>	
Approvals	
Standards	IEC61643-11, EN61643-11

<b>Dimensions / Signalling contact info</b>	
Clamping range (nominal / min. / max.)	mm <sup>2</sup>
Height x width x depth	mm
Signalling contact	
<b>Note</b>	

<b>no remote sig. contact</b>	<b>with remote signalling (R)</b>
16 / 4 / 50	16 / 4 / 50
94 / 71.2 / 69	106 / 71.2 / 69
No	250 V 1A 1CO
<b>Note</b>	

<b>no remote sig. contact</b>	<b>with remote signalling (R)</b>
16 / 4 / 50	16 / 4 / 50
94 / 53.4 / 69	106 / 53.4 / 69
No	250 V 1A 1CO
<b>Note</b>	

**Ordering data**

	no remote sig. contact
	with remote signalling (R)
<b>Note</b>	

<b>Type</b>	<b>Qty.</b>	<b>Order No.</b>
VPU I 4 280V/12,5KA	1	1352180000
VPU I 4 R 280V/12,5KA	1	1352190000
<b>Note</b>		

<b>Type</b>	<b>Qty.</b>	<b>Order No.</b>
VPU I 3 280V/12,5KA	1	1352200000
VPU I 3 R 280V/12,5KA	1	1352220000
<b>Note</b>		

**Accessories**

<b>Note</b>
-------------

Pluggable spare arrester VPU I 0 400 V/12.5 kA-1352280000
---

Pluggable spare arrester VPU I 0 280 V/12.5 kA-1352120000
---

**Type I and II lightning arrester for use downstream of electrical meter**

- Suitable for lightning protection level III and IV (LPL III/IV)
- Pluggable arresters
- Tested according to IEC 61643-11 for Type I and II lightning and surge protection

**VPU I 2/R 280 V / 12.5 kA**

1-phase

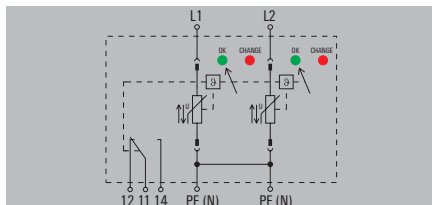

**VPU I 1/R 280 V / 12.5 kA**

1-phase

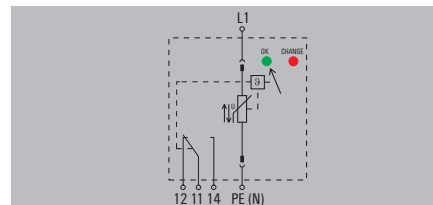

**Technical data**

Rated voltage (AC)  
 Highest continuous current (AC)  
 Temporary surge voltage (over-voltage) - TOV  
 Requirements category acc. to IEC 61643-11  
 Lightning test current  $I_{imp}$  (10/350  $\mu$ s)  
 Short-circuit strength with max. back-up fuse  
 Discharge current  $I_n$  (8/20 $\mu$ s) wire-wire  
 Discharge current  $I_{max}$  (8/20 $\mu$ s) wire-PE  
 Short-circuit resistance  $I_{SCCR}$   
 Total discharge current  $I_{total}$   
 PE conductor current  $I_{PE}$   
 Sparkover time / Drop-out time  
 Fusing  
 Protection level  $U_p$  (typical)  
 Optical function display  
 Design  
 Colour  
 Ambient temperature (operational)

**Connection according to IEC 947-7-1**

Solid  
 Stranded  
 Stripping length  
 Tightening torque

**Approvals**

Approvals  
 Standards

230 V  
 280 V  
 335 V  
 Type I, Type II  
 12.5 kA  
 25 kA<sub>eff</sub>  
 25 kA  
 50 kA  
 25 kA  
 25 kA  
 30  $\mu$ A  
 $\leq 25$  ns  
 250 A gL  
 $\leq 1.4$  kV  
 green = OK; red = arrester is defective - replace  
 Installation housing; 2TE, Insta IP 20  
 Black, Arrester red  
 -40 °C...+70 °C

4...16 mm<sup>2</sup>  
 2.5...50 mm<sup>2</sup>  
 15 mm  
 2...3 Nm

IEC61643-11, EN61643-11

230 V  
 280 V  
 335 V  
 Type I, Type II  
 12.5 kA  
 25 kA<sub>eff</sub>  
 25 kA  
 50 kA  
 25 kA  
 12.5 kA  
 30  $\mu$ A  
 $\leq 25$  ns  
 250 A gL  
 $\leq 1.4$  kV  
 green = OK; red = arrester is defective - replace  
 Installation housing; 1TE, Insta IP 20  
 Black, Arrester red  
 -40 °C...+70 °C

4...16 mm<sup>2</sup>  
 2.5...50 mm<sup>2</sup>  
 15 mm  
 2...3 Nm

IEC61643-11, EN61643-11

**Dimensions / Signalling contact info**

Clamping range (nominal / min. / max.) mm<sup>2</sup>  
 Height x width x depth mm  
 Signalling contact

**Note**

**no remote sig. contact      with remote signalling (R)**

16 / 4 / 50      16 / 4 / 50  
 94 / 35.6 / 69      106 / 35.6 / 69  
 No      250 V 1A 1CO

**no remote sig. contact      with remote signalling (R)**

16 / 4 / 50      16 / 4 / 50  
 94 / 17.8 / 69      106 / 17.8 / 69  
 No      250 V 1A 1CO

**Ordering data**

no remote sig. contact  
 with remote signalling (R)

Type	Qty.	Order No.
VPU I 2 280V/12,5KA	1	1352150000
VPU I 2 R 280V/12,5KA	1	1352170000

Type	Qty.	Order No.
VPU I 1 280V/12,5KA	1	1352130000
VPU I 1 R 280V/12,5KA	1	1352140000

**Note**

**Accessories**

**Note**

Pluggable spare arrester VPU I 0 280 V/12.5 kA-1352120000

Pluggable spare arrester VPU I 0 280 V/12.5 kA-1352120000



**Type I and II lightning arrester for use downstream of electrical meter**

- Suitable for lightning protection level III and IV (LPL III/IV)
- Pluggable arresters
- Tested according to IEC 61643-11 for Type I and II lightning and surge protection

**VPU I 3+1/R 280 V / 12.5 kA**

TN-S, TT

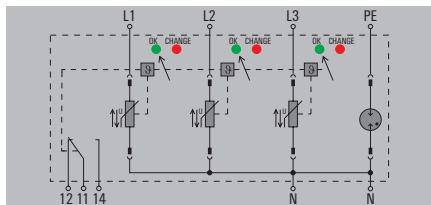

**VPU I 1+1/R 280 V / 12.5 kA**

1-phase

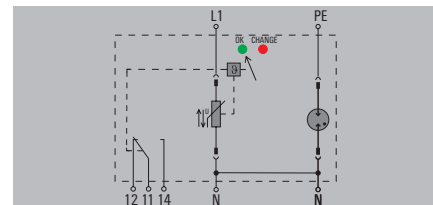

**Technical data**

Rated voltage (AC)  
 Highest continuous current (AC)  
 Temporary surge voltage (over-voltage) - TOV  
 Requirements category acc. to IEC 61643-11  
 Lightning test current  $I_{imp}$  (10/350  $\mu$ s)  
 Short-circuit strength with max. back-up fuse  
 Discharge current  $I_n$  (8/20 $\mu$ s) wire-wire  
 Discharge current  $I_{max}$  (8/20 $\mu$ s) wire-PE  
 Short-circuit resistance  $I_{SCCR}$   
 Total discharge current  $I_{total}$   
 PE conductor current  $I_{PE}$   
 Sparkover time / Drop-out time  
 Fusing  
 Protection level  $U_p$  (typical)  
 Optical function display  
 Design  
 Colour  
 Ambient temperature (operational)

**Connection according to IEC 947-7-1**

Solid  
 Stranded  
 Stripping length  
 Tightening torque

**Approvals**

Approvals  
 Standards

230 V  
 280 V  
 335 V  
 Type I, Type II  
 12.5 kA  
 25 kA<sub>eff</sub>  
 25 kA  
 50 kA  
 25 kA  
 50 kA  
 30  $\mu$ A  
 $\leq 25$  ns,  $\leq 100$  ns  
 250 A gL  
 $\leq 1.4$  kV  
 green = OK; red = arrester is defective - replace  
 Installation housing; 4TE, Insta IP 20  
 Black, Arrester red / blue  
 -40 °C...+70 °C

4...16 mm<sup>2</sup>  
 2.5...50 mm<sup>2</sup>  
 15 mm  
 2...3 Nm

IEC61643-11, EN61643-11

230 V  
 280 V  
 335 V  
 Type I, Type II  
 12.5 kA  
 25 kA<sub>eff</sub>  
 25 kA  
 50 kA  
 25 kA  
 25 kA  
 30  $\mu$ A  
 $\leq 25$  ns,  $\leq 100$  ns  
 250 A gL  
 $\leq 1.4$  kV  
 green = OK; red = arrester is defective - replace  
 Installation housing; 2TE, Insta IP 20  
 Black, Arrester red / blue  
 -40 °C...+70 °C

4...16 mm<sup>2</sup>  
 2.5...50 mm<sup>2</sup>  
 15 mm  
 2...3 Nm

IEC61643-11, EN61643-11

**Dimensions / Signalling contact info**

Clamping range (nominal / min. / max.) mm<sup>2</sup>  
 Height x width x depth mm  
 Signalling contact

**Note**

**no remote sig. contact      with remote signalling (R)**

16 / 4 / 50      16 / 4 / 50  
 94 / 71.2 / 69      106 / 71.2 / 69  
 No      250 V 1A 1CO

**no remote sig. contact      with remote signalling (R)**

16 / 4 / 50      16 / 4 / 50  
 94 / 35.6 / 69      106 / 35.6 / 69  
 No      250 V 1A 1CO

**Ordering data**

no remote sig. contact  
 with remote signalling (R)

Type	Qty.	Order No.
VPU I 3+1 280V/12,5KA	1	1352230000
VPU I 3+1 R 280V/12,5KA	1	1352240000

Type	Qty.	Order No.
VPU I 1+1 280V/12,5KA	1	1352250000
VPU I 1+1 R 280V/12,5KA	1	1352270000

**Note**

**Accessories**

**Note**

Pluggable spare arrester L-N VPU I 0 280 V/12.5 kA-1352120000,  
 N-PE VPU I 0 N-PE 260 V/100 kA-1351940000

Pluggable spare arrester L-N VPU I 0 280 V/12.5 kA-1352120000,  
 N-PE VPU I 0 N-PE 260 V/50 kA-1351930000

**Type I and II lightning arrester for use downstream of electrical meter**

- Suitable for lightning protection level III and IV (LPL III/IV)
- Pluggable arresters
- Tested according to IEC61643-11 for Type I and II lightning and surge protection

**VPU I 3+1 400 V / 12.5 kA**

TN-S, TT, IT

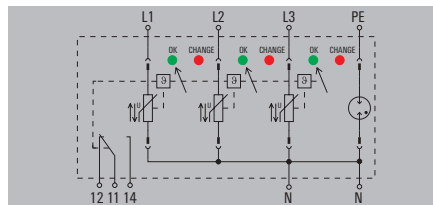

**VPU I 3 400 V / 12.5 kA**

TN-C

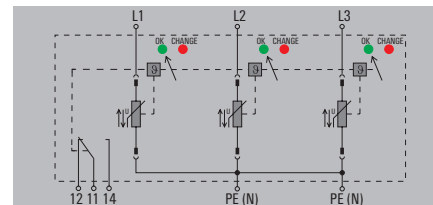

**Technical data**

Rated voltage (AC)  
 Highest continuous current (AC)  
 Temporary surge voltage (over-voltage) - TOV  
 Requirements category acc. to IEC 61643-11  
 Lightning test current  $I_{imp}$  (10/350  $\mu$ s)  
 Short-circuit strength with max. back-up fuse  
 Discharge current  $I_n$  (8/20 $\mu$ s) wire-wire  
 Discharge current  $I_{max}$  (8/20 $\mu$ s) wire-PE  
 Short-circuit resistance  $I_{SCCR}$   
 Total discharge current  $I_{total}$   
 PE conductor current  $I_{PE}$   
 Sparkover time / Drop-out time  
 Fusing  
 Protection level  $U_p$  (typical)  
 Optical function display  
 Design  
 Colour  
 Ambient temperature (operational)

**Connection according to IEC 947-7-1**

Solid  
 Stranded  
 Stripping length  
 Tightening torque

**Approvals**

Approvals  
 Standards

400 V  
 440 V  
 620 V  
 Type I, Type II  
 12.5 kA  
 25 kA<sub>eff</sub>  
 25 kA  
 50 kA  
 25 kA  
 50 kA  
 30  $\mu$ A  
 $\leq 25$  ns,  $\leq 100$  ns  
 250 A gL  
 $\leq 1.8$  kV  
 green = OK; red = arrester is defective - replace  
 Installation housing; 4TE, Insta IP 20  
 Black, Arrester red / blue  
 -40 °C...+70 °C

4...16 mm<sup>2</sup>  
 2.5...50 mm<sup>2</sup>  
 15 mm  
 2...3 Nm

IEC61643-11, EN61643-11

400 V  
 440 V  
 620 V  
 Type I, Type II  
 12.5 kA  
 25 kA<sub>eff</sub>  
 25 kA  
 50 kA  
 25 kA  
 37.5 kA  
 30  $\mu$ A  
 $\leq 25$  ns  
 250 A gL  
 $\leq 1.8$  kV  
 green = OK; red = arrester is defective - replace  
 Installation housing; 3TE, Insta IP 20  
 Black, Arrester red  
 -40 °C...+70 °C

4...16 mm<sup>2</sup>  
 2.5...50 mm<sup>2</sup>  
 15 mm  
 2...3 Nm

IEC61643-11, EN61643-11

**Dimensions / Signalling contact info**

Clamping range (nominal / min. / max.) mm<sup>2</sup>  
 Height x width x depth mm  
 Signalling contact

**Note**

**no remote sig. contact      with remote signalling (R)**

16 / 4 / 50      16 / 4 / 50  
 94 / 71.2 / 69      106 / 71.2 / 69  
 No      250 V 1A 1CO

**no remote sig. contact      with remote signalling (R)**

16 / 4 / 50      16 / 4 / 50  
 94 / 53.4 / 69      106 / 53.4 / 69  
 No      250 V 1A 1CO

**Ordering data**

no remote sig. contact  
 with remote signalling (R)

Type	Qty.	Order No.
VPU I 3+1 400V/12,5KA	1	1352370000
VPU I 3+1 R 400V/12,5KA	1	1352380000

Type	Qty.	Order No.
VPU I 3 400V/12,5KA	1	1352340000
VPU I 3 R 400V/12,5KA	1	1352350000

**Note**

**Accessories**

**Note**

Pluggable spare arrester L-N VPU I 0 400 V/12.5 kA-1352280000,  
 N-PE VPU I 0 N-PE 440 V/100 kA-1351990000

Pluggable spare arrester VPU I 0 400 V/12.5 kA-1352280000





**Type I and II lightning arrester for use downstream of the electrical meter**

**Type I and II lightning arrester for use downstream of electrical meter**

- Suitable for lightning protection level III and IV (LPL III/IV)
- Pluggable arresters
- Tested according to IEC61643-11 for Type I and II lightning and surge protection

**VPU I 1/R 400 V / 12.5 kA**

1-phase

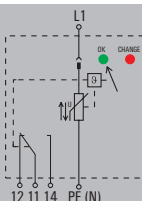

**VPU I 1+1/R 400 V / 12.5 kA**

1-phase

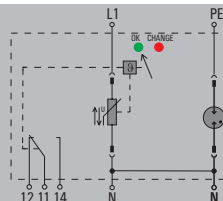

**Technical data**

Rated voltage (AC)  
 Highest continuous current (AC)  
 Temporary surge voltage (over-voltage) - TOV  
 Requirements category acc. to IEC 61643-11  
 Lightning test current  $I_{imp}$  (10/350  $\mu$ s)  
 Short-circuit strength with max. back-up fuse  
 Discharge current  $I_n$  (8/20 $\mu$ s) wire-wire  
 Discharge current  $I_{max}$  (8/20 $\mu$ s) wire-PE  
 Short-circuit resistance  $I_{SCCR}$   
 Total discharge current  $I_{total}$   
 PE conductor current  $I_{PE}$   
 Sparkover time / Drop-out time  
 Fusing  
 Protection level  $U_p$  (typical)  
 Optical function display  
 Design  
 Colour  
 Ambient temperature (operational)

**Connection according to IEC 947-7-1**

Solid  
 Stranded  
 Stripping length  
 Tightening torque

**Approvals**

Approvals  
 Standards

400 V  
 440 V  
 620 V  
 Type I, Type II  
 12.5 kA  
 25 kA<sub>eff</sub>  
 25 kA  
 50 kA  
 25 kA  
 12.5 kA  
 30  $\mu$ A  
 $\leq 25$  ns  
 250 A gL  
 $\leq 1.8$  kV  
 green = OK; red = arrester is defective - replace  
 Installation housing; 1TE, Insta IP 20  
 Black, Arrester red  
 -40 °C...+70 °C

4...16 mm<sup>2</sup>  
 2.5...50 mm<sup>2</sup>  
 15 mm  
 2...3 Nm

IEC61643-11, EN61643-11

400 V  
 440 V  
 620 V  
 Type I, Type II  
 12.5 kA  
 25 kA<sub>eff</sub>  
 25 kA  
 50 kA  
 25 kA  
 25 kA  
 30  $\mu$ A  
 $\leq 25$  ns,  $\leq 100$  ns  
 250 A gL  
 $\leq 1.8$  kV  
 green = OK; red = arrester is defective - replace  
 Installation housing; 2TE, Insta IP 20  
 Black, Arrester red / blue  
 -40 °C...+70 °C

4...16 mm<sup>2</sup>  
 2.5...50 mm<sup>2</sup>  
 15 mm  
 2...3 Nm

IEC61643-11, EN61643-11

**Dimensions / Signalling contact info**

Clamping range (nominal / min. / max.) mm<sup>2</sup>  
 Height x width x depth mm  
 Signalling contact

**Note**

**no remote sig. contact      with remote signalling (R)**

16 / 4 / 50	16 / 4 / 50
94 / 17.8 / 69	106 / 17.8 / 69
No	250 V 1A 1CO

**no remote sig. contact      with remote signalling (R)**

16 / 4 / 50	16 / 4 / 50
94 / 35.6 / 69	106 / 35.6 / 69
No	250 V 1A 1CO

**Ordering data**

no remote sig. contact  
 with remote signalling (R)

Type	Qty.	Order No.
VPU I 1 400V/12,5KA	1	1352290000
VPU I 1 R 400V/12,5KA	1	1352300000

Type	Qty.	Order No.
VPU I 1+1 400V/12,5KA	1	1352320000
VPU I 1+1 R 400V/12,5KA	1	1352330000

**Note**

**Accessories**

**Note**

Pluggable spare arrester VPU I 0 400 V/12.5 kA-1352280000

Pluggable spare arrester L-N VPU I 0 400 V/12.5 kA-1352280000,  
 N-PE VPU I 0 N-PE 440 V/50 kA-1351980000

**Type I lightning arrester**

- Blow out version
- No decoupling necessary thanks to trigger electronics
- Suitable for networks with high short-circuit currents
- Suitable for lightning protection level I, II, III, IV.

**PU I 1 TSG+ 50 kA / 0.9 kV-330 V**

For use in industrial systems

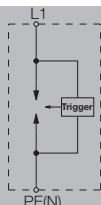

**PU I 1 TSG+ 50 kA / 1.5 kV-440 V**

For use in industrial systems

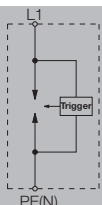

**Technical data**

Rated voltage (AC)	330 V
Highest continuous current (AC)	330 V
Temporary surge voltage (over-voltage) - TOV	350 V
Requirements category acc. to IEC 61643-11	Type I
Lightning test current $I_{imp}$ (10/350 $\mu$ s)	50 kA with 25 As charge
Short-circuit strength with max. back-up fuse	25 kA <sub>eff</sub>
Discharge current $I_n$ (8/20 $\mu$ s) wire-wire	
Discharge current $I_{max}$ (8/20 $\mu$ s) wire-PE	
Short-circuit resistance $I_{SCCR}$	25 kA
Total discharge current $I_{total}$	50 kA
Rated load current $I_l$	
PE conductor current $I_{PE}$	3 mA
Leakage current at $U_n$	3 mA
Sparkover time / Drop-out time	$\leq 150$ ns
Fusing	250 A gL
Protection level $U_p$ (typical)	$\leq 0.9$ kV
Optical function display	Green LED
Design	Insta IP 20
Colour	Black
Ambient temperature (operational)	-40 °C...+85 °C
<b>Connection according to IEC 947-7-1</b>	
Solid	10...35 mm <sup>2</sup>
Stranded	10...35 mm <sup>2</sup>
Stripping length	19 mm
Tightening torque	6...8 Nm
<b>Approvals</b>	
Approvals	CE; GOSTME25
Standards	

Rated voltage (AC)	440 V
Highest continuous current (AC)	440 V
Temporary surge voltage (over-voltage) - TOV	440 V
Requirements category acc. to IEC 61643-11	Type I
Lightning test current $I_{imp}$ (10/350 $\mu$ s)	50 kA with 25 As charge
Short-circuit strength with max. back-up fuse	25 kA <sub>eff</sub>
Discharge current $I_n$ (8/20 $\mu$ s) wire-wire	
Discharge current $I_{max}$ (8/20 $\mu$ s) wire-PE	
Short-circuit resistance $I_{SCCR}$	25 kA
Total discharge current $I_{total}$	50 kA
Rated load current $I_l$	
PE conductor current $I_{PE}$	3 mA
Leakage current at $U_n$	3 mA
Sparkover time / Drop-out time	$\leq 150$ ns
Fusing	250 A gL
Protection level $U_p$ (typical)	$\leq 1500$ V
Optical function display	Green LED
Design	Insta IP 20
Colour	Black
Ambient temperature (operational)	-40 °C...+85 °C
<b>Connection according to IEC 947-7-1</b>	
Solid	16...35 mm <sup>2</sup>
Stranded	10...35 mm <sup>2</sup>
Stripping length	19 mm
Tightening torque	6...8 Nm
<b>Approvals</b>	
Approvals	CE; GOSTME25
Standards	

<b>Dimensions / Signalling contact info</b>	
Clamping range (nominal / min. / max.)	mm <sup>2</sup>
Height x width x depth	mm
Signalling contact	
<b>Note</b>	
no remote sig. contact	
<b>Dimensions / Signalling contact info</b>	
Clamping range (nominal / min. / max.)	mm <sup>2</sup>
Height x width x depth	mm
Signalling contact	
<b>Note</b>	
no remote sig. contact	

**Dimensions / Signalling contact info**

Clamping range (nominal / min. / max.)	mm <sup>2</sup>
Height x width x depth	mm
Signalling contact	
<b>Note</b>	
no remote sig. contact	

**no remote sig. contact**

Clamping range (nominal / min. / max.)	35 / 10 / 35
Height x width x depth	150 / 35 / 80
Signalling contact	No
<b>Note</b>	
Minimum distance 10 cm to base plate	

**no remote sig. contact**

Clamping range (nominal / min. / max.)	35 / 16 / 35
Height x width x depth	150 / 35 / 80
Signalling contact	No
<b>Note</b>	
Minimum distance 10 cm to base plate	

**Ordering data**

Type	no remote sig. contact
------	------------------------

Type	Qty.	Order No.
PU1TSG Plus 330 VAC 0,9kV	1	8561220000

Type	Qty.	Order No.
PU1TSG PLUS 440VAC 1,5kV	1	8561250000

**Note**

Cross-connector QB 36-3 order no. 8816090000

**Note**

Cross-connector QB 36-3 order no. 8816090000

**Note**

Cross-connector QB 36-3 order no. 8816090000

**Accessories**

**Note**



# Surge protection for low-voltage consumer installations and electronics

## Surge protection of type II

The Weidmüller VPU II series surge protection protects low-voltage consumer installations and electronic devices against voltage surges that arise through, for example, atmospheric discharge (lightning) or switching activities (transients).

The VPU II series satisfies the type II requirements of IEC 61643-11:2011 and type 2 requirements of EN 61643-11:2012.

### Electrical connection

Connect the VPU II surge protection between the phase conductors (L1, L2, L3) or, as the case may be, the neutral conductor (N) and earth of the consumer installation. The connecting conductors should be kept as short as possible. A helpful feature is that the protective unit can rotate 180°.



Ensure that unprotected conductors (e.g. wires to the meter) are not run parallel to protected wires.

The universal "3+1" circuit for TN or TT systems is available from the Weidmüller product range.

The VPU II surge protection is available as a compact module with 1, 2, 3 or 4 poles, with the PE connections already internally connected within the module.

We can supply the following voltage rating versions:

$U_n$ : 60 V AC =  $U_c$ : 75 V  
 $U_n$ : 120/230 V AC =  $U_c$ : 150 V  
 $U_n$ : 230/400 V AC =  $U_c$ : 280 V  
 $U_n$ : 400/690 V AC =  $U_c$ : 400 V  
 $U_n$ : 470/600 V AC =  $U_c$ : 600 V  
 $U_n$ : 750/1200 V AC =  $U_c$ : 750 V

as well as for the 3+1 circuit and special types for IT networks.

The VPU II series offers a choice of voltage ( $U_n \leq U_c$ ) and number of arresters to satisfy the various power systems. The national regulations and safety information must be observed, see IEC60364-5-53 or DIN VDE 0100 pt 534.

### Functional checks, maintenance and approvals

VPU II surge modules can be checked visually by the user. The visual check is simple to perform because the arrester is provided with a thermal disconnecter. If this has responded, i.e. is no longer providing protection, the flag in the status window changes from green to red.



A non-functioning arrester can be replaced by a qualified technician without having to disconnect any wiring. The plug-in top sections of varistors are coded according to voltage. This means it is not possible to plug in the wrong replacement varistor.

### LCF function

The leakage current free protection circuit (LCF function) is achieved by connecting the varistor and sparkover gap in series.

This protection circuit is needed in the case of an insulation monitoring device, for example.

### Connection

The cross-section of the earth conductor is in accordance with the requirements of the national standards. The fuse for VPU II modules is selected on the basis of conductor cross-section and type of routing. A maximum of 125 A gG/gL is permitted.

VPU II series arresters from Weidmüller are suitable for the following cross-sections:

- solid wire: 4...16 mm<sup>2</sup>
- stranded wire: 4...50 mm<sup>2</sup>
- flexible: 4...25 mm<sup>2</sup>

The operating temperature range is -40 °C...+70 °C.

### V-form connection

When using cross-connections from the RCD or fuses to the VPU II, a V-form wiring arrangement can be used.

### Remote signalling contact (R)

All modules of the VPU II series are available with the option of a remote signalling contact which is integrated directly in the module. This potential-free contact should be connected as a changeover contact using a PUSH IN plug connection. The contact's electrical data is: 250 V AC / 1 A or 24 V DC / 0.1 A.

### Co-ordination with other arresters

The VPU II series can be installed with the following Weidmüller surge protection devices without decoupling.

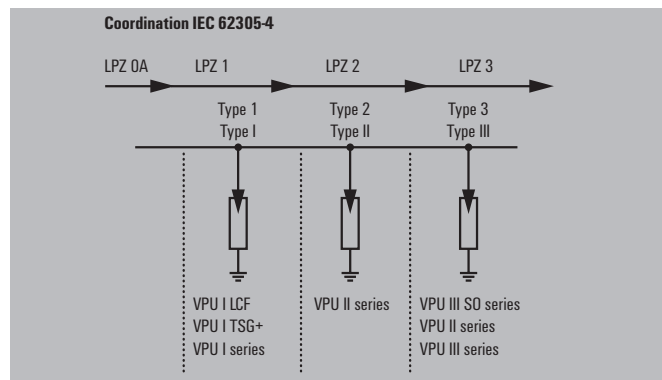

### Dimensional drawing VPU II series

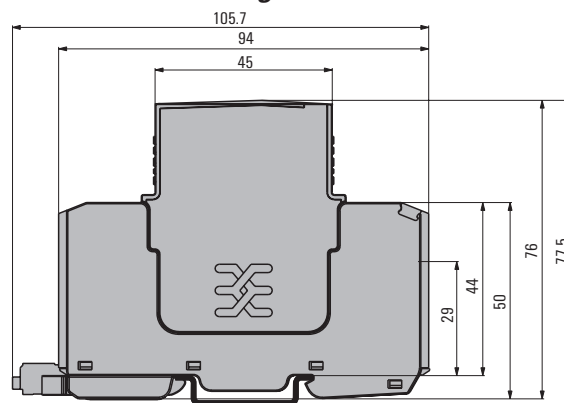

### Overall width

- VPU II, single-pole, 18 mm
- VPU II, two-pole, 36 mm
- VPU II, three-pole, 54 mm
- VPU II, four-pole, 72 mm

### Accessories: Link and remote signalling contact

Type		grey	blue
	QB 18-4 insulated	8877520000	8877510000
	QB 18-3 insulated	8877500000	8877530000
	QB 18-2 insulated	8877540000	8877550000
	Remote signalling contact PLUG VPU	1402570000	



## Type II surge protection

### Type II/III surge protection $U_c$ : 280 V Suitable for 230/400 V mains systems

- Pluggable arrester
- Coded voltage level
- High energy absorption with short time to sparkover
- Arrester can be rotated through 180°
- No follow-on current
- Installation in distribution board
- Thermal protection function
- Co-ordination with VPU Type I

### VPU II 4/R 280 V / 40 kA

TN-S

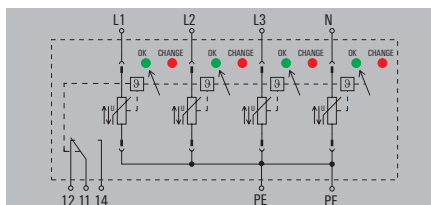

### VPU II 3/R 280 V / 40 kA

TN-C

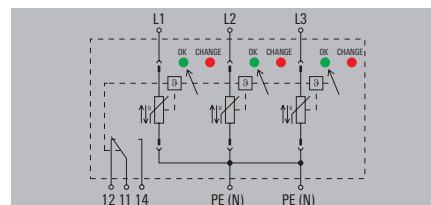

### Technical data

Rated voltage  
Max. continuous voltage,  $U_c$  (AC)  
Requirements category acc. to IEC 61643-11  
Rated discharge current (8/20  $\mu$ s)  $I_N$   
Limiting discharge current (8/20  $\mu$ s)  $I_{max}$   
Discharge current, max. (8/20  $\mu$ s)  
Combined pulse  $U_{oc}$   
Short-circuit resistance  $I_{scCR}$   
Total discharge current  $I_{total}$   
PE conductor current  $I_{PE}$   
Sparkover time / Drop-out time  
Fusing  
Protection level  $U_p$  (typical)  
Temporary surge voltage (over-voltage) - TOV  
Optical function display  
Design  
Colour  
Ambient temperature (operational)  
Storage temperature

#### Connection according to IEC 947-7-1

Solid  
Stranded  
Stripping length  
Tightening torque

#### Approvals

Approvals  
Standards

230 V / 400 V  
280 V  
Type II, Type III  
20 kA  
40 kA  
40 kA  
10 kV  
25 kA  
160 kA  
30  $\mu$ A  
 $\leq 25$  ns  
125 A gL  
 $\leq 1.55$  kV  
440 V  
green = OK; red = arrester is defective - replace  
Installation housing; 4TE, Insta IP 20  
Black, Arrester red  
-40 °C...+70 °C  
-40 °C ... +80 °C

2.5...16 mm<sup>2</sup>  
2.5...50 mm<sup>2</sup>  
15 mm  
2...3 Nm

IEC61643-11, EN61643-11

230 V / 400 V  
280 V  
Type II, Type III  
20 kA  
40 kA  
40 kA  
10 kV  
25 kA  
120 kA  
30  $\mu$ A  
 $\leq 25$  ns  
125 A gL  
 $\leq 1.55$  kV  
440 V  
green = OK; red = arrester is defective - replace  
Installation housing; 3TE  
Black, Arrester red  
-40 °C...+70 °C  
-40 °C ... +80 °C

2.5...16 mm<sup>2</sup>  
2.5...50 mm<sup>2</sup>  
15 mm  
2...3 Nm

IEC61643-11, EN61643-11

#### Dimensions / Signalling contact info

Clamping range (nominal / min. / max.) mm<sup>2</sup>  
Height x width x depth mm  
Signalling contact

#### Note

#### no remote sig. contact with remote signalling (R)

no remote sig. contact	with remote signalling (R)
16 / 2.5 / 50	16 / 2.5 / 50
94 / 71.2 / 69	106 / 71.2 / 69
No	250 V 1A 1CO

#### no remote sig. contact with remote signalling (R)

no remote sig. contact	with remote signalling (R)
16 / 2.5 / 50	16 / 2.5 / 50
94 / 53.4 / 69	106 / 53.4 / 69
No	250 V 1A 1CO

### Ordering data

no remote sig. contact  
with remote signalling (R)

Type	Qty.	Order No.
VPU II 4 280V/40KA	1	1352680000
VPU II 4 R 280V/40KA	1	1352690000

Type	Qty.	Order No.
VPU II 3 280V/40KA	1	1352700000
VPU II 3 R 280V/40KA	1	1352720000

#### Note

### Accessories

#### Note

Pluggable spare arrester VPU II 0 280 V/40 kA-1352570000

Pluggable spare arrester VPU II 0 280 V/40 kA-1352570000

**Type II/III surge protection  $U_c$ : 280 V**  
**Suitable for 230/400 V mains systems**

- Pluggable arrester
- Coded voltage level
- High energy absorption with short time to sparkover
- Arrester can be rotated through 180°
- No follow-on current
- Installation in distribution board
- Thermal protection function
- Co-ordination with VPU Type I

**VPU II 3+1/R 280 V / 40 kA**

TN-S, TT

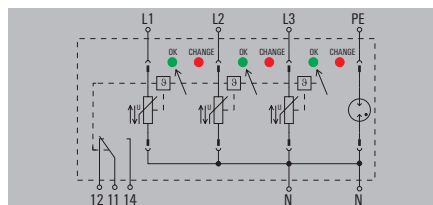

**VPU II 1+1/R 280 V / 40 kA**

1-phase

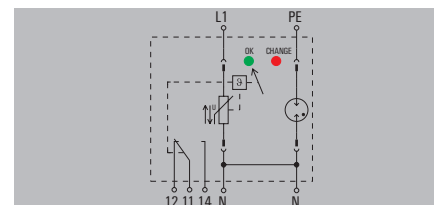

**Technical data**

Rated voltage	230 V / 400 V
Max. continuous voltage, $U_c$ (AC)	280 V
Requirements category acc. to IEC 61643-11	Type II, Type III
Rated discharge current (8/20 $\mu$ s) $I_n$	20 kA
Discharge current, max. (8/20 $\mu$ s)	40 kA
Combined pulse $U_{oc}$	10 kV
Short-circuit resistance $I_{scCR}$	25 kA
Total discharge current $I_{total}$	160 kA
PE conductor current $I_{PE}$	30 $\mu$ A
Sparkover time / Drop-out time	$\leq 25$ ns, $\leq 100$ ns
Fusing	125 A gL
Protection level $U_p$ (typical)	$\leq 1.55$ kV
Temporary surge voltage (over-voltage) - TOV	440 V
Optical function display	green = OK; red = arrester is defective - replace
Design	Installation housing; 4TE, Insta IP 20
Colour	Black, Arrester red / blue
Ambient temperature (operational)	-40 °C...+70 °C
Storage temperature	-40 °C ... +80 °C

**Connection according to IEC 947-7-1**

Solid	2.5...16 mm <sup>2</sup>
Stranded	2.5...50 mm <sup>2</sup>
Stripping length	15 mm
Tightening torque	2...3 Nm

**Approvals**

Approvals	IEC61643-11, EN61643-11
Standards	

Rated voltage	230 V
Max. continuous voltage, $U_c$ (AC)	280 V
Requirements category acc. to IEC 61643-11	Type II, Type III
Rated discharge current (8/20 $\mu$ s) $I_n$	20 kA
Discharge current, max. (8/20 $\mu$ s)	40 kA
Combined pulse $U_{oc}$	10 kV
Short-circuit resistance $I_{scCR}$	25 kA
Total discharge current $I_{total}$	160 kA
PE conductor current $I_{PE}$	30 $\mu$ A
Sparkover time / Drop-out time	$\leq 25$ ns, $\leq 100$ ns
Fusing	125 A gL
Protection level $U_p$ (typical)	$\leq 1.55$ kV
Temporary surge voltage (over-voltage) - TOV	440 V
Optical function display	green = OK; red = arrester is defective - replace
Design	Installation housing; 2TE, Insta IP 20
Colour	Black, Arrester red / blue
Ambient temperature (operational)	-40 °C...+70 °C
Storage temperature	-40 °C ... +80 °C

Solid	2.5...16 mm <sup>2</sup>
Stranded	2.5...50 mm <sup>2</sup>
Stripping length	15 mm
Tightening torque	2...3 Nm

Approvals	IEC61643-11, EN61643-11
Standards	

Rated voltage	230 V
Max. continuous voltage, $U_c$ (AC)	280 V
Requirements category acc. to IEC 61643-11	Type II, Type III
Rated discharge current (8/20 $\mu$ s) $I_n$	20 kA
Discharge current, max. (8/20 $\mu$ s)	40 kA
Combined pulse $U_{oc}$	10 kV
Short-circuit resistance $I_{scCR}$	25 kA
Total discharge current $I_{total}$	80 kA
PE conductor current $I_{PE}$	30 $\mu$ A
Sparkover time / Drop-out time	$\leq 25$ ns, $\leq 100$ ns
Fusing	125 A gL
Protection level $U_p$ (typical)	$\leq 1.55$ kV
Temporary surge voltage (over-voltage) - TOV	440 V
Optical function display	green = OK; red = arrester is defective - replace
Design	Installation housing; 2TE, Insta IP 20
Colour	Black, Arrester red / blue
Ambient temperature (operational)	-40 °C...+70 °C
Storage temperature	-40 °C ... +80 °C

Solid	2.5...16 mm <sup>2</sup>
Stranded	2.5...50 mm <sup>2</sup>
Stripping length	15 mm
Tightening torque	2...3 Nm

Approvals	IEC61643-11, EN61643-11
Standards	

**Dimensions / Signalling contact info**

Clamping range (nominal / min. / max.)	mm <sup>2</sup>
Height x width x depth	mm
Signalling contact	

**Note**

**no remote sig. contact      with remote signalling (R)**

Clamping range (nominal / min. / max.)	16 / 2.5 / 50	16 / 2.5 / 50
Height x width x depth	94 / 71.2 / 69	106 / 71.2 / 69
Signalling contact	No	250 V 1A 1CO

**no remote sig. contact      with remote signalling (R)**

Clamping range (nominal / min. / max.)	16 / 2.5 / 50	16 / 2.5 / 50
Height x width x depth	94 / 35.6 / 69	106 / 35.6 / 69
Signalling contact	No	250 V 1A 1CO

**Ordering data**

Type	no remote sig. contact	Qty.	Order No.
VPU II 3+1 280V/40KA	with remote signalling (R)	1	1352650000
VPU II 3+1 R 280V/40KA		1	1352670000

**Note**

Type	no remote sig. contact	Qty.	Order No.
VPU II 1+1 280V/40KA	with remote signalling (R)	1	1352630000
VPU II 1+1 R 280V/40KA		1	1352640000

**Accessories**

Note	Pluggable spare arrester L-N VPU II 0 280 V/40 kA-1352570000, N-PE VPU II 0 N-PE 260 V/40 kA-1351180000
------	---

Note	Pluggable spare arrester L-N VPU II 0 280 V/40 kA-1352570000, N-PE VPU II 0 N-PE 260 V/40 kA-1351180000
------	---

## Type II surge protection

### Type II/III surge protection $U_c$ : 280 V Suitable for 230/400 V mains systems

- Pluggable arrester
- Coded voltage level
- High energy absorption with short time to sparkover
- Arrester can be rotated through 180°
- No follow-on current
- Installation in distribution board
- Thermal protection function
- Co-ordination with VPU Type I

### VPU II 2/R 280 V / 40 kA

1-phase

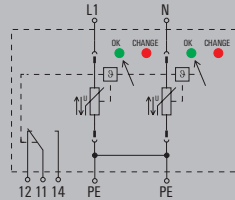

### VPU II 1/R 280 V / 40 kA

1-phase

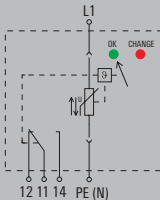

### Technical data

Rated voltage	230 V
Max. continuous voltage, $U_c$ (AC)	280 V
Requirements category acc. to IEC 61643-11	Type II, Type III
Rated discharge current (8/20 $\mu$ s) $I_n$	20 kA
Limiting discharge current (8/20 $\mu$ s) $I_{max}$	40 kA
Discharge current, max. (8/20 $\mu$ s)	40 kA
Combined pulse $U_{oc}$	10 kV
Short-circuit resistance $I_{scCR}$	25 kA
Total discharge current $I_{total}$	80 kA
PE conductor current $I_{PE}$	30 $\mu$ A
Sparkover time / Drop-out time	$\leq 25$ ns
Fusing	125 A gL
Protection level $U_p$ (typical)	$\leq 1.55$ kV
Temporary surge voltage (over-voltage) - TOV	440 V
Optical function display	green = OK; red = arrester is defective - replace
Design	Installation housing; 2TE, Insta IP 20
Colour	Black, Arrester red
Ambient temperature (operational)	-40 °C...+70 °C
Storage temperature	-40 °C ... +80 °C

#### Connection according to IEC 947-7-1

Solid	2.5...16 mm <sup>2</sup>
Stranded	2.5...50 mm <sup>2</sup>
Stripping length	15 mm
Tightening torque	2...3 Nm

#### Approvals

Approvals	IEC61643-11, EN61643-11
Standards	

#### Dimensions / Signalling contact info

Clamping range (nominal / min. / max.)	mm <sup>2</sup>
Height x width x depth	mm
Signalling contact	No

#### Note

### Ordering data

Type	Qty.	Order No.
VPU II 2 280V/40KA	1	1352600000
VPU II 2 R 280V/40KA	1	1352620000

#### Note

### Accessories

Note	Pluggable spare arrester VPU II 0 280 V/40 kA-1352570000
------	--

Rated voltage	230 V
Max. continuous voltage, $U_c$ (AC)	280 V
Requirements category acc. to IEC 61643-11	Type II, Type III
Rated discharge current (8/20 $\mu$ s) $I_n$	20 kA
Limiting discharge current (8/20 $\mu$ s) $I_{max}$	40 kA
Discharge current, max. (8/20 $\mu$ s)	40 kA
Combined pulse $U_{oc}$	10 kV
Short-circuit resistance $I_{scCR}$	25 kA
Total discharge current $I_{total}$	40 kA
PE conductor current $I_{PE}$	30 $\mu$ A
Sparkover time / Drop-out time	$\leq 25$ ns
Fusing	125 A gL
Protection level $U_p$ (typical)	$\leq 1.55$ kV
Temporary surge voltage (over-voltage) - TOV	440 V
Optical function display	green = OK; red = arrester is defective - replace
Design	Installation housing; 1TE
Colour	Black, Arrester red
Ambient temperature (operational)	-40 °C...+70 °C
Storage temperature	-40 °C ... +80 °C

Connection according to IEC 947-7-1	2.5...16 mm <sup>2</sup>
Solid	2.5...50 mm <sup>2</sup>
Stranded	15 mm
Stripping length	2...3 Nm
Tightening torque	

#### Approvals

Approvals	IEC61643-11, EN61643-11
Standards	

#### Dimensions / Signalling contact info

Clamping range (nominal / min. / max.)	mm <sup>2</sup>
Height x width x depth	mm
Signalling contact	No

#### Note

Type	Qty.	Order No.
VPU II 1 280V/40KA	1	1352580000
VPU II 1 R 280V/40KA	1	1352590000

#### Note

Note	Pluggable spare arrester VPU II 0 280 V/40 kA-1352570000
------	--

**Type II/III surge protection  $U_c$ : 280 V**  
**Suitable for 230/400 V mains systems**

- Leakage current free, pluggable arrester
- Coded voltage level
- High energy absorption with short time to sparkover
- Arrester can be rotated through 180°
- No follow-on current
- Installation in distribution board
- Thermal protection function
- Co-ordination with VPU Type I

**VPU II 4 LCF/R 280 V / 20 kA**

TN-S

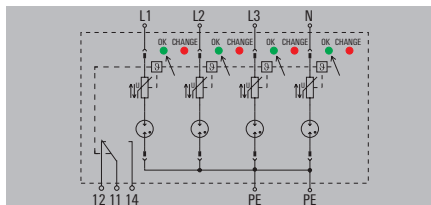

**VPU II 3 LCF/R 280 V / 20 kA**

TN-C

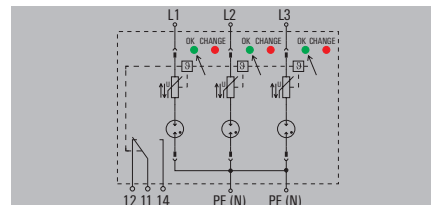

**Technical data**

Rated voltage	230 V / 400 V
Max. continuous voltage, $U_c$ (AC)	280 V
Requirements category acc. to IEC 61643-11	Type II, Type III
Rated discharge current (8/20 $\mu$ s) $I_n$	20 kA
Limiting discharge current (8/20 $\mu$ s) $I_{max}$	40 kA
Discharge current, max. (8/20 $\mu$ s)	40 kA
Combined pulse $U_{oc}$	10 kV
Short-circuit resistance $I_{scCR}$	25 kA
Total discharge current $I_{total}$	160 kA
PE conductor current $I_{PE}$	0 $\mu$ A
Sparkover time / Drop-out time	$\leq 100$ ns
Fusing	125 A gL
Protection level $U_p$ (typical)	$\leq 1.8$ kV
Temporary surge voltage (over-voltage) - TOV	440 V
Optical function display	green = OK; red = arrester is defective - replace
Design	Installation housing: 4TE, Insta IP 20
Colour	Black, Arrester red
Ambient temperature (operational)	-40 °C...+70 °C
Storage temperature	-40 °C ... +80 °C

**Connection according to IEC 947-7-1**

Solid	2.5...16 mm <sup>2</sup>
Stranded	2.5...50 mm <sup>2</sup>
Stripping length	15 mm
Tightening torque	2...3 Nm

**Approvals**

Approvals	IEC61643-11, EN61643-11
Standards	

**Dimensions / Signalling contact info**

Clamping range (nominal / min. / max.)	mm <sup>2</sup>
Height x width x depth	mm
Signalling contact	No

**Note**

**Ordering data**

Type	Qty.	Order No.
VPU II 4 LCF 280V/40KA	1	1352770000
VPU II 4R LCF 280V/40KA	1	1352780000

**Note**

**Accessories**

<b>Note</b>	Pluggable spare arrester VPU II 0 280 V/40 kA-1352570000
-------------	--

230 V / 400 V

280 V

Type II, Type III

20 kA

40 kA

40 kA

10 kV

25 kA

160 kA

0  $\mu$ A

$\leq 100$  ns

125 A gL

$\leq 1.8$  kV

440 V

green = OK; red = arrester is defective - replace

Installation housing: 4TE, Insta IP 20

Black, Arrester red

-40 °C...+70 °C

-40 °C ... +80 °C

2.5...16 mm<sup>2</sup>

2.5...50 mm<sup>2</sup>

15 mm

2...3 Nm

IEC61643-11, EN61643-11

no remote sig. contact

16 / 2.5 / 50

94 / 71.2 / 69

No

with remote signalling (R)

16 / 2.5 / 50

106 / 71.2 / 69

250 V 1A 1CO

230 V / 400 V

280 V

Type II, Type III

20 kA

40 kA

40 kA

10 kV

25 kA

120 kA

0  $\mu$ A

$\leq 100$  ns

125 A gL

$\leq 1.8$  kV

440 V

green = OK; red = arrester is defective - replace

Installation housing: 3TE, Insta IP 20

Black, Arrester red

-40 °C...+70 °C

-40 °C ... +80 °C

2.5...16 mm<sup>2</sup>

2.5...50 mm<sup>2</sup>

15 mm

2...3 Nm

IEC61643-11, EN61643-11

no remote sig. contact

16 / 2.5 / 50

94 / 53.4 / 69

No

with remote signalling (R)

16 / 2.5 / 50

106 / 53.4 / 69

250 V 1A 1CO

Type	Qty.	Order No.
VPU II 3 LCF 280V/40KA	1	1352790000
VPU II 3R LCF 280V/40KA	1	1352800000

**Note**

Pluggable spare arrester VPU II 0 280 V/40 kA-1352570000





## Type II surge protection

### Type II/III surge protection $U_c$ : 280 V

#### Suitable for 230/400 V mains systems

- Leakage current free, pluggable arrester
- Coded voltage level
- High energy absorption with short time to sparkover
- Arrester can be rotated through 180°
- No follow-on current
- Installation in distribution board
- Thermal protection function
- Co-ordination with VPU Type I

### VPU II 1 LCF / R 280 V / 20 KA

1-phase

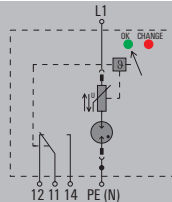

#### Technical data

Rated voltage	230 V
Max. continuous voltage, $U_c$ (AC)	280 V
Requirements category acc. to IEC 61643-11	Type II, Type III
Rated discharge current (8/20 $\mu$ s) $I_n$	20 kA
Limiting discharge current (8/20 $\mu$ s) $I_{max}$	40 kA
Discharge current, max. (8/20 $\mu$ s)	40 kA
Combined pulse $U_{oc}$	10 kV
Short-circuit resistance $I_{scCR}$	25 kA
Total discharge current $I_{total}$	40 kA
PE conductor current $I_{PE}$	0 $\mu$ A
Sparkover time / Drop-out time	$\leq 100$ ns
Fusing	125 A gL
Protection level $U_p$ (typical)	$\leq 1.8$ kV
Temporary surge voltage (over-voltage) - TOV	440 V
Optical function display	green = OK; red = arrester is defective - replace
Design	Installation housing; 1TE, Insta IP 20
Colour	Black, Arrester red
Ambient temperature (operational)	-40 °C...+70 °C
Storage temperature	-40 °C ... +80 °C
<b>Connection according to IEC 947-7-1</b>	
Solid	2.5...16 mm <sup>2</sup>
Stranded	2.5...50 mm <sup>2</sup>
Stripping length	15 mm
Tightening torque	2...3 Nm
<b>Approvals</b>	
Approvals	
Standards	IEC61643-11, EN61643-11

Rated voltage	230 V
Max. continuous voltage, $U_c$ (AC)	280 V
Requirements category acc. to IEC 61643-11	Type II, Type III
Rated discharge current (8/20 $\mu$ s) $I_n$	20 kA
Limiting discharge current (8/20 $\mu$ s) $I_{max}$	40 kA
Discharge current, max. (8/20 $\mu$ s)	40 kA
Combined pulse $U_{oc}$	10 kV
Short-circuit resistance $I_{scCR}$	25 kA
Total discharge current $I_{total}$	40 kA
PE conductor current $I_{PE}$	0 $\mu$ A
Sparkover time / Drop-out time	$\leq 100$ ns
Fusing	125 A gL
Protection level $U_p$ (typical)	$\leq 1.8$ kV
Temporary surge voltage (over-voltage) - TOV	440 V
Optical function display	green = OK; red = arrester is defective - replace
Design	Installation housing; 1TE, Insta IP 20
Colour	Black, Arrester red
Ambient temperature (operational)	-40 °C...+70 °C
Storage temperature	-40 °C ... +80 °C
<b>Connection according to IEC 947-7-1</b>	
Solid	2.5...16 mm <sup>2</sup>
Stranded	2.5...50 mm <sup>2</sup>
Stripping length	15 mm
Tightening torque	2...3 Nm
<b>Approvals</b>	
Approvals	
Standards	IEC61643-11, EN61643-11

<b>Dimensions / Signalling contact info</b>	
Clamping range (nominal / min. / max.)	mm <sup>2</sup>
Height x width x depth	mm
Signalling contact	
<b>Note</b>	

<b>no remote sig. contact</b>	<b>with remote signalling (R)</b>
16 / 2.5 / 50	16 / 2.5 / 50
94 / 17.8 / 69	105 / 17.8 / 69
No	250 V 1A 1CO
<b>Note</b>	

#### Ordering data

	no remote sig. contact
	with remote signalling (R)
<b>Note</b>	

<b>Type</b>	<b>Qty.</b>	<b>Order No.</b>
VPU II 1 LCF 280V/40KA	1	1352740000
VPU II 1R LCF 280V/40KA	1	1352750000
<b>Note</b>		

#### Accessories

<b>Note</b>
-------------

Pluggable spare arrester VPU II O 280 V/40 kA-1352570000
--



## Type II surge protection

### Type II/III surge protection $U_c$ : 400 V

Suitable for 400/690 V mains systems

- Pluggable arrester
- Coded voltage level
- High energy absorption with short time to sparkover
- Arrester can be rotated through 180°
- No follow-on current
- Installation in distribution board
- Thermal protection function
- Co-ordination with VPU Type I

### VPU II 4/R 400 V / 40 kA

TN-S

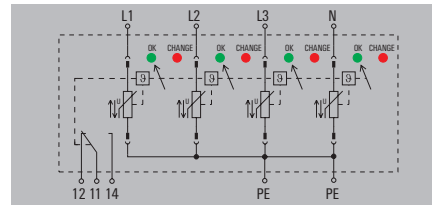

### VPU II 3/R 400 V / 40 kA

TN-C

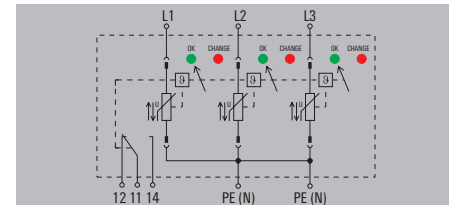

### Technical data

Rated voltage	400 V / 690 V
Max. continuous voltage, $U_c$ (AC)	400 V
Requirements category acc. to IEC 61643-11	Type II, Type III
Rated discharge current (8/20 $\mu$ s) $I_n$	20 kA
Limiting discharge current (8/20 $\mu$ s) $I_{max}$	40 kA
Discharge current, max. (8/20 $\mu$ s)	40 kA
Combined pulse $U_{oc}$	10 kV
Short-circuit resistance $I_{scCR}$	25 kA
Total discharge current $I_{total}$	160 kA
PE conductor current $I_{PE}$	30 $\mu$ A
Sparkover time / Drop-out time	$\leq 25$ ns
Fusing	125 A gL
Protection level $U_p$ (typical)	$\leq 2.1$ kV
Temporary surge voltage (over-voltage) - TOV	620 V
Optical function display	green = OK; red = arrester is defective - replace
Design	Installation housing: 4TE, Insta IP 20
Colour	Black, Arrester red
Ambient temperature (operational)	-40 °C...+70 °C
Storage temperature	-40 °C ... +80 °C
<b>Connection according to IEC 947-7-1</b>	
Solid	2.5...16 mm <sup>2</sup>
Stranded	2.5...50 mm <sup>2</sup>
Stripping length	15 mm
Tightening torque	2...3 Nm
<b>Approvals</b>	
Approvals	IEC61643-11, EN61643-11
Standards	

Rated voltage	400 V / 690 V
Max. continuous voltage, $U_c$ (AC)	400 V
Requirements category acc. to IEC 61643-11	Type II, Type III
Rated discharge current (8/20 $\mu$ s) $I_n$	20 kA
Limiting discharge current (8/20 $\mu$ s) $I_{max}$	40 kA
Discharge current, max. (8/20 $\mu$ s)	40 kA
Combined pulse $U_{oc}$	10 kV
Short-circuit resistance $I_{scCR}$	25 kA
Total discharge current $I_{total}$	120 kA
PE conductor current $I_{PE}$	30 $\mu$ A
Sparkover time / Drop-out time	$\leq 25$ ns
Fusing	125 A gL
Protection level $U_p$ (typical)	$\leq 2.1$ kV
Temporary surge voltage (over-voltage) - TOV	620 V
Optical function display	green = OK; red = arrester is defective - replace
Design	Installation housing: 3TE, Insta IP 20
Colour	Black, Arrester red
Ambient temperature (operational)	-40 °C...+70 °C
Storage temperature	-40 °C ... +80 °C
<b>Connection according to IEC 947-7-1</b>	
Solid	2.5...16 mm <sup>2</sup>
Stranded	2.5...50 mm <sup>2</sup>
Stripping length	15 mm
Tightening torque	2...3 Nm
<b>Approvals</b>	
Approvals	IEC61643-11, EN61643-11
Standards	

Rated voltage	400 V / 690 V
Max. continuous voltage, $U_c$ (AC)	400 V
Requirements category acc. to IEC 61643-11	Type II, Type III
Rated discharge current (8/20 $\mu$ s) $I_n$	20 kA
Limiting discharge current (8/20 $\mu$ s) $I_{max}$	40 kA
Discharge current, max. (8/20 $\mu$ s)	40 kA
Combined pulse $U_{oc}$	10 kV
Short-circuit resistance $I_{scCR}$	25 kA
Total discharge current $I_{total}$	120 kA
PE conductor current $I_{PE}$	30 $\mu$ A
Sparkover time / Drop-out time	$\leq 25$ ns
Fusing	125 A gL
Protection level $U_p$ (typical)	$\leq 2.1$ kV
Temporary surge voltage (over-voltage) - TOV	620 V
Optical function display	green = OK; red = arrester is defective - replace
Design	Installation housing: 3TE, Insta IP 20
Colour	Black, Arrester red
Ambient temperature (operational)	-40 °C...+70 °C
Storage temperature	-40 °C ... +80 °C
<b>Connection according to IEC 947-7-1</b>	
Solid	2.5...16 mm <sup>2</sup>
Stranded	2.5...50 mm <sup>2</sup>
Stripping length	15 mm
Tightening torque	2...3 Nm
<b>Approvals</b>	
Approvals	IEC61643-11, EN61643-11
Standards	

### Dimensions / Signalling contact info

Clamping range (nominal / min. / max.)	mm <sup>2</sup>
Height x width x depth	mm
Signalling contact	
<b>Note</b>	

	no remote sig. contact	with remote signalling (R)
Clamping range (nominal / min. / max.)	16 / 2.5 / 50	16 / 2.5 / 50
Height x width x depth	94 / 71.2 / 69	106 / 71.2 / 69
Signalling contact	No	250 V 1A 1CO
<b>Note</b>		

	no remote sig. contact	with remote signalling (R)
Clamping range (nominal / min. / max.)	16 / 2.5 / 50	16 / 2.5 / 50
Height x width x depth	94 / 53.4 / 69	106 / 53.4 / 69
Signalling contact	No	250 V 1A 1CO
<b>Note</b>		

### Ordering data

no remote sig. contact	
with remote signalling (R)	

Type	Qty.	Order No.
VPU II 4 400V/40KA	1	1352900000
VPU II 4 R 400V/40KA	1	1352920000

Type	Qty.	Order No.
VPU II 3 400V/40KA	1	1352880000
VPU II 3 R 400V/40KA	1	1352890000

### Note

### Accessories

<b>Note</b>	
-------------	--

Pluggable spare arrester VPU II 0 400 V/40 kA-1352820000
--

Pluggable spare arrester VPU II 0 400 V/40 kA-1352820000
--

**Type II/III surge protection  $U_c$ : 400 V**  
**Suitable for 400/690 V mains systems**

- Pluggable arrester
- Coded voltage level
- High energy absorption with short time to sparkover
- Arrester can be rotated through 180°
- No follow-on current
- Installation in distribution board
- Thermal protection function
- Co-ordination with VPU Type I

**VPU II 2/R 400 V / 40 kA**

1-phase

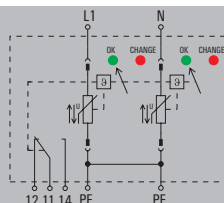

**VPU II 1/R 400 V / 40 kA**

1-phase

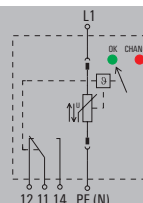

**Technical data**

Rated voltage	400 V
Max. continuous voltage, $U_c$ (AC)	400 V
Requirements category acc. to IEC 61643-11	Type II, Type III
Rated discharge current (8/20 $\mu$ s) $I_n$	20 kA
Limiting discharge current (8/20 $\mu$ s) $I_{max}$	40 kA
Discharge current, max. (8/20 $\mu$ s)	40 kA
Combined pulse $U_{oc}$	10 kV
Short-circuit resistance $I_{scCR}$	25 kA
Total discharge current $I_{total}$	80 kA
PE conductor current $I_{PE}$	30 $\mu$ A
Sparkover time / Drop-out time	$\leq 25$ ns
Fusing	125 A gL
Protection level $U_p$ (typical)	$\leq 2.1$ kV
Temporary surge voltage (over-voltage) - TOV	620 V
Optical function display	green = OK; red = arrester is defective - replace
Design	Installation housing; 2TE, Insta IP 20
Colour	Black, Arrester red
Ambient temperature (operational)	-40 °C...+70 °C
Storage temperature	-40 °C ... +80 °C

**Connection according to IEC 947-7-1**

Solid	2.5...16 mm <sup>2</sup>
Stranded	2.5...50 mm <sup>2</sup>
Stripping length	15 mm
Tightening torque	2...3 Nm

**Approvals**

Approvals	IEC61643-11, EN61643-11
Standards	

**Dimensions / Signalling contact info**

Clamping range (nominal / min. / max.)	mm <sup>2</sup>
Height x width x depth	mm
Signalling contact	No

**Note**

**Ordering data**

	no remote sig. contact
	with remote signalling (R)

**Note**

**Accessories**

**Note**

Rated voltage	400 V
Max. continuous voltage, $U_c$ (AC)	400 V
Requirements category acc. to IEC 61643-11	Type II, Type III
Rated discharge current (8/20 $\mu$ s) $I_n$	20 kA
Limiting discharge current (8/20 $\mu$ s) $I_{max}$	40 kA
Discharge current, max. (8/20 $\mu$ s)	40 kA
Combined pulse $U_{oc}$	10 kV
Short-circuit resistance $I_{scCR}$	25 kA
Total discharge current $I_{total}$	80 kA
PE conductor current $I_{PE}$	30 $\mu$ A
Sparkover time / Drop-out time	$\leq 25$ ns
Fusing	125 A gL
Protection level $U_p$ (typical)	$\leq 2.1$ kV
Temporary surge voltage (over-voltage) - TOV	620 V
Optical function display	green = OK; red = arrester is defective - replace
Design	Installation housing; 2TE, Insta IP 20
Colour	Black, Arrester red
Ambient temperature (operational)	-40 °C...+70 °C
Storage temperature	-40 °C ... +80 °C

Solid	2.5...16 mm <sup>2</sup>
Stranded	2.5...50 mm <sup>2</sup>
Stripping length	15 mm
Tightening torque	2...3 Nm

IEC61643-11, EN61643-11

**no remote sig. contact**

Clamping range (nominal / min. / max.)	16 / 2.5 / 50
Height x width x depth	94 / 35.6 / 69
Signalling contact	No

**with remote signalling (R)**

Clamping range (nominal / min. / max.)	16 / 2.5 / 50
Height x width x depth	106 / 35.6 / 69
Signalling contact	250 V 1A 1CO

Type	Qty.	Order No.
VPU II 2 400V/40KA	1	1352850000
VPU II 2 R 400V/40KA	1	1352870000

Pluggable spare arrester VPU II 0 400 V/40 kA-1352820000

Rated voltage	400 V
Max. continuous voltage, $U_c$ (AC)	400 V
Requirements category acc. to IEC 61643-11	Type II, Type III
Rated discharge current (8/20 $\mu$ s) $I_n$	20 kA
Limiting discharge current (8/20 $\mu$ s) $I_{max}$	40 kA
Discharge current, max. (8/20 $\mu$ s)	40 kA
Combined pulse $U_{oc}$	10 kV
Short-circuit resistance $I_{scCR}$	25 kA
Total discharge current $I_{total}$	40 kA
PE conductor current $I_{PE}$	30 $\mu$ A
Sparkover time / Drop-out time	$\leq 25$ ns
Fusing	125 A gL
Protection level $U_p$ (typical)	$\leq 2.1$ kV
Temporary surge voltage (over-voltage) - TOV	620 V
Optical function display	green = OK; red = arrester is defective - replace
Design	Installation housing; 1TE, Insta IP 20
Colour	Black, Arrester red
Ambient temperature (operational)	-40 °C...+70 °C
Storage temperature	-40 °C ... +80 °C

Solid	2.5...16 mm <sup>2</sup>
Stranded	2.5...50 mm <sup>2</sup>
Stripping length	15 mm
Tightening torque	2...3 Nm

IEC61643-11, EN61643-11

**no remote sig. contact**

Clamping range (nominal / min. / max.)	16 / 2.5 / 50
Height x width x depth	94 / 17.8 / 69
Signalling contact	No

**with remote signalling (R)**

Clamping range (nominal / min. / max.)	16 / 2.5 / 50
Height x width x depth	106 / 17.8 / 69
Signalling contact	250 V 1A 1CO

Type	Qty.	Order No.
VPU II 1 400V/40KA	1	1352830000
VPU II 1 R 400V/40KA	1	1352840000

Pluggable spare arrester VPU II 0 400 V/40 kA-1352820000



## Type II surge protection

### Type II N-PE arrester

- Tested according to IEC 61643-11 Type II
- Pluggable N-PE arrester
- Coded voltage level
- High energy absorption with short time to sparkover
- Insert can be rotated through 180°
- Installation in distribution board

### VPU II 1 N-PE

N-PE arrester 440 V

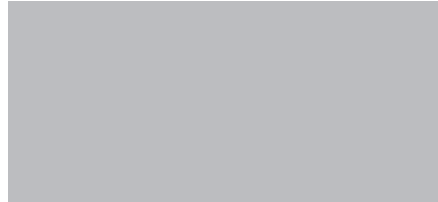
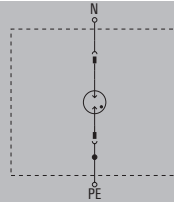

### Technical data

Rated voltage  
 Max. continuous voltage,  $U_c$  (AC)  
 Requirements category acc. to IEC 61643-11  
 Rated discharge current (8/20  $\mu$ s)  $I_n$   
 Limiting discharge current (8/20  $\mu$ s)  $I_{max}$   
 Discharge current, max. (8/20  $\mu$ s)  
 Combined pulse  $U_{oc}$   
 Short-circuit resistance  $I_{SCCR}$   
 Total discharge current  $I_{total}$   
 PE conductor current  $I_{PE}$   
 Sparkover time / Drop-out time  
 Fusing  
 Protection level  $U_p$  (typical)  
 Temporary surge voltage (over-voltage) - TOV  
 Optical function display  
 Design  
 Colour  
 Ambient temperature (operational)  
 Storage temperature

230 V  
 260 V  
 Type II, Type III  
 20 kA  
 40 kA  
 40 kA  
 10 kV  
 100 A  
 40 kA  
 0  $\mu$ A  
 $\leq 100$  ns  
  
 $\leq 1.5$  kV  
 1200 V  
 No  
 Installation housing: 1TE, Insta IP 20  
 Black, Arrester blue  
 -40 °C...+70 °C  
 -40 °C ... +80 °C

#### Connection according to IEC 947-7-1

Solid 2.5...16 mm<sup>2</sup>  
 Stranded 2.5...50 mm<sup>2</sup>  
 Stripping length 15 mm  
 Tightening torque 2...3 Nm

#### Approvals

Approvals  
 Standards IEC61643-11, EN61643-11

#### Dimensions / Signalling contact info

Clamping range (nominal / min. / max.) mm<sup>2</sup> 16 / 2.5 / 50  
 Height x width x depth mm 94 / 17.8 / 69  
 Signalling contact No

#### Note

### Ordering data

Type	Qty.	Order No.
VPU II 1 N-PE 260V/40KA	1	1351170000

#### Note

### Accessories

Note Pluggable spare arrester VPU II 0 N-PE 440 V/40 kA-1351180000





## Type II surge protection

### Type II/III surge protection $U_c$ : 150 V Suitable for 120/240 V mains systems

- Pluggable arrester
- Coded voltage level
- High energy absorption with short time to sparkover
- Arrester can be rotated through 180°
- No follow-on current
- Installation in distribution board
- Thermal protection function
- Co-ordination with VPU Type I

### VPU II 4/R 150 V / 40 kA

TN-S

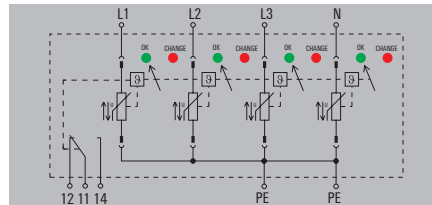

### VPU II 3/R 150 V / 40 kA

TN-C

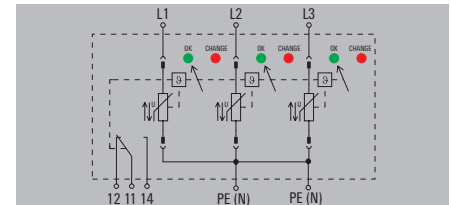

### Technical data

Rated voltage  
Max. continuous voltage,  $U_c$  (AC)  
Requirements category acc. to IEC 61643-11  
Rated discharge current (8/20  $\mu$ s)  $I_n$   
Limiting discharge current (8/20  $\mu$ s)  $I_{max}$   
Discharge current, max. (8/20  $\mu$ s)  
Combined pulse  $U_{oc}$   
Short-circuit resistance  $I_{scCR}$   
Total discharge current  $I_{total}$   
PE conductor current  $I_{PE}$   
Sparkover time / Drop-out time  
Fusing  
Protection level  $U_p$  (typical)  
Temporary surge voltage (over-voltage) - TOV  
Optical function display  
Design  
Colour  
Ambient temperature (operational)  
Storage temperature

#### Connection according to IEC 947-7-1

Solid  
Stranded  
Stripping length  
Tightening torque

#### Approvals

Approvals  
Standards

120 V / 240 V  
150 V  
Type II, Type III  
20 kA  
40 kA  
40 kA  
10 kV  
25 kA  
160 kA  
30  $\mu$ A  
 $\leq 25$  ns  
125 A gL  
 $\leq 0.9$  kV  
230 V  
green = OK; red = arrester is defective - replace  
Installation housing: 4TE, Insta IP 20  
Black, Arrester red  
-40 °C...+70 °C  
-40 °C ... +80 °C

2.5...16 mm<sup>2</sup>  
2.5...50 mm<sup>2</sup>  
15 mm  
2...3 Nm

IEC61643-11, EN61643-11

120 V / 240 V  
150 V  
Type II, Type III  
20 kA  
40 kA  
40 kA  
10 kV  
25 kA  
120 kA  
30  $\mu$ A  
 $\leq 25$  ns  
125 A gL  
 $\leq 0.9$  kV  
230 V  
green = OK; red = arrester is defective - replace  
Installation housing: 3TE  
Black, Arrester red  
-40 °C...+70 °C  
-40 °C ... +80 °C

2.5...16 mm<sup>2</sup>  
2.5...50 mm<sup>2</sup>  
15 mm  
2...3 Nm

IEC61643-11, EN61643-11

#### Dimensions / Signalling contact info

Clamping range (nominal / min. / max.) mm<sup>2</sup>  
Height x width x depth mm  
Signalling contact

#### Note

#### no remote sig. contact with remote signalling (R)

no remote sig. contact	with remote signalling (R)
16 / 2.5 / 50	16 / 2.5 / 50
94 / 71.2 / 69	106 / 71.2 / 69
No	250 V 1 A 1 NC

#### no remote sig. contact with remote signalling (R)

no remote sig. contact	with remote signalling (R)
16 / 2.5 / 50	16 / 2.5 / 50
94 / 53.4 / 69	106 / 53.4 / 69
No	250 V 1 A 1 NC

### Ordering data

no remote sig. contact  
with remote signalling (R)

Type	Qty.	Order No.
VPU II 4 150V/40KA	1	1352540000
VPU II 4 R 150V/40KA	1	1352550000

Type	Qty.	Order No.
VPU II 3 150V/40KA	1	1352520000
VPU II 3 R 150V/40KA	1	1352530000

#### Note

### Accessories

#### Note

Pluggable spare arrester VPU II 0 150 V/40 kA-1352450000

Pluggable spare arrester VPU II 0 150 V/40 kA-1352450000

**Type II/III surge protection  $U_c$ : 150 V**  
**Suitable for 120/240 V mains systems**

- Pluggable arrester
- Coded voltage level
- High energy absorption with short time to sparkover
- Arrester can be rotated through 180°
- No follow-on current
- Installation in distribution board
- Thermal protection function
- Co-ordination with VPU Type I

**VPU II 2/R 150 V / 40 kA**

1-phase

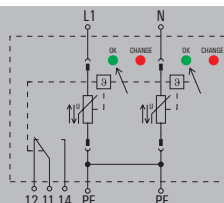

**VPU II 1/R 150 V / 40 kA**

1-phase

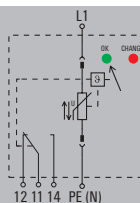

**Technical data**

Rated voltage	120 V
Max. continuous voltage, $U_c$ (AC)	150 V
Requirements category acc. to IEC 61643-11	Type II, Type III
Rated discharge current (8/20 $\mu$ s) $I_n$	20 kA
Limiting discharge current (8/20 $\mu$ s) $I_{max}$	40 kA
Discharge current, max. (8/20 $\mu$ s)	40 kA
Combined pulse $U_{oc}$	10 kV
Short-circuit resistance $I_{scCR}$	25 kA
Total discharge current $I_{total}$	80 kA
PE conductor current $I_{PE}$	30 $\mu$ A
Sparkover time / Drop-out time	$\leq 25$ ns
Fusing	125 A gL
Protection level $U_p$ (typical)	$\leq 0.9$ kV
Temporary surge voltage (over-voltage) - TOV	230 V
Optical function display	green = OK; red = arrester is defective - replace
Design	Installation housing; 2TE, Insta IP 20
Colour	Black, Arrester red
Ambient temperature (operational)	-40 °C...+70 °C
Storage temperature	-40 °C ... +80 °C

**Connection according to IEC 947-7-1**

Solid	2.5...16 mm <sup>2</sup>
Stranded	2.5...50 mm <sup>2</sup>
Stripping length	15 mm
Tightening torque	2...3 Nm

**Approvals**

Approvals	IEC61643-11, EN61643-11
Standards	

Rated voltage	120 V
Max. continuous voltage, $U_c$ (AC)	150 V
Requirements category acc. to IEC 61643-11	Type II, Type III
Rated discharge current (8/20 $\mu$ s) $I_n$	20 kA
Limiting discharge current (8/20 $\mu$ s) $I_{max}$	40 kA
Discharge current, max. (8/20 $\mu$ s)	40 kA
Combined pulse $U_{oc}$	10 kV
Short-circuit resistance $I_{scCR}$	25 kA
Total discharge current $I_{total}$	80 kA
PE conductor current $I_{PE}$	30 $\mu$ A
Sparkover time / Drop-out time	$\leq 25$ ns
Fusing	125 A gL
Protection level $U_p$ (typical)	$\leq 0.9$ kV
Temporary surge voltage (over-voltage) - TOV	230 V
Optical function display	green = OK; red = arrester is defective - replace
Design	Installation housing; 2TE, Insta IP 20
Colour	Black, Arrester red
Ambient temperature (operational)	-40 °C...+70 °C
Storage temperature	-40 °C ... +80 °C

Solid	2.5...16 mm <sup>2</sup>
Stranded	2.5...50 mm <sup>2</sup>
Stripping length	15 mm
Tightening torque	2...3 Nm

IEC61643-11, EN61643-11

Rated voltage	120 V
Max. continuous voltage, $U_c$ (AC)	150 V
Requirements category acc. to IEC 61643-11	Type II, Type III
Rated discharge current (8/20 $\mu$ s) $I_n$	20 kA
Limiting discharge current (8/20 $\mu$ s) $I_{max}$	40 kA
Discharge current, max. (8/20 $\mu$ s)	40 kA
Combined pulse $U_{oc}$	10 kV
Short-circuit resistance $I_{scCR}$	25 kA
Total discharge current $I_{total}$	40 kA
PE conductor current $I_{PE}$	30 $\mu$ A
Sparkover time / Drop-out time	$\leq 25$ ns
Fusing	125 A gL
Protection level $U_p$ (typical)	$\leq 0.9$ kV
Temporary surge voltage (over-voltage) - TOV	230 V
Optical function display	green = OK; red = arrester is defective - replace
Design	Installation housing; 1TE, Insta IP 20
Colour	Black, Arrester red
Ambient temperature (operational)	-40 °C...+70 °C
Storage temperature	-40 °C ... +80 °C

Solid	2.5...16 mm <sup>2</sup>
Stranded	2.5...50 mm <sup>2</sup>
Stripping length	15 mm
Tightening torque	2...3 Nm

IEC61643-11, EN61643-11

**Dimensions / Signalling contact info**

Clamping range (nominal / min. / max.)	mm <sup>2</sup>
Height x width x depth	mm
Signalling contact	

**Note**

**no remote sig. contact      with remote signalling (R)**

Clamping range (nominal / min. / max.)	16 / 2.5 / 50
Height x width x depth	94 / 35.6 / 69
Signalling contact	No      250 V 1 A 1 NC

**no remote sig. contact      with remote signalling (R)**

Clamping range (nominal / min. / max.)	16 / 2.5 / 50
Height x width x depth	94 / 17.8 / 69
Signalling contact	No      250 V 1 A 1 NC

**Ordering data**

Type	no remote sig. contact
Qty.	with remote signalling (R)
Order No.	

Type	Qty.	Order No.
VPU II 2 150V/40KA	1	1352490000
VPU II 2 R 150V/40KA	1	1352500000

Type	Qty.	Order No.
VPU II 1 150V/40KA	1	1352470000
VPU II 1 R 150V/40KA	1	1352480000

**Note**

**Accessories**

Note	Pluggable spare arrester VPU II 0 150 V/40 kA-1352450000
------	--

Note	Pluggable spare arrester VPU II 0 150 V/40 kA-1352450000
------	--



## Type II surge protection

### Type II/III surge protection $U_c$ : 75 V

- Pluggable arrester
- Coded voltage level
- High energy absorption with short time to sparkover
- Arrester can be rotated through 180°
- No follow-on current
- Installation in distribution board
- Thermal protection function

### VPU II 2/R 75 V / 30 kA

1-phase

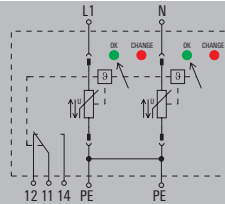

### VPU II 1/R 75 V / 30 kA

1-phase

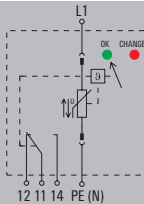

### Technical data

Rated voltage  
 Max. continuous voltage,  $U_c$  (AC)  
 Requirements category acc. to IEC 61643-11  
 Rated discharge current (8/20  $\mu$ s)  $I_n$   
 Limiting discharge current (8/20  $\mu$ s)  $I_{max}$   
 Discharge current, max. (8/20  $\mu$ s)  
 Combined pulse  $U_{oc}$   
 Short-circuit resistance  $I_{SCCR}$   
 Total discharge current  $I_{total}$   
 PE conductor current  $I_{PE}$   
 Sparkover time / Drop-out time  
 Fusing  
 Protection level  $U_p$  (typical)  
 Temporary surge voltage (over-voltage) - TOV  
 Optical function display  
 Design  
 Colour  
 Ambient temperature (operational)  
 Storage temperature

#### Connection according to IEC 947-7-1

Solid  
 Stranded  
 Stripping length  
 Tightening torque

#### Approvals

Approvals  
 Standards

48 V  
 75 V  
 Type II, Type III  
 15 kA  
 30 kA  
 30 kA  
 10 kV  
 25 kA  
 60 kA  
 30  $\mu$ A  
 $\leq 25$  ns  
 125 A gL  
 $\leq 0.65$  kV  
 92 V  
 green = OK; red = arrester is defective - replace  
 Installation housing; 2TE  
 Black, Arrester red  
 -40 °C...+70 °C  
 -40 °C ... +80 °C

2.5...16 mm<sup>2</sup>  
 2.5...50 mm<sup>2</sup>  
 15 mm  
 2...3 Nm

IEC61643-11, EN61643-11

48 V  
 75 V  
 Type II, Type III  
 15 kA  
 30 kA  
 30 kA  
 10 kV  
 25 kA  
 30 kA  
 30  $\mu$ A  
 $\leq 25$  ns  
 125 A gL  
 $\leq 0.65$  kV  
 92 V  
 green = OK; red = arrester is defective - replace  
 Installation housing; 1TE, Insta IP 20  
 Black, Arrester red  
 -40 °C...+70 °C  
 -40 °C ... +80 °C

2.5...16 mm<sup>2</sup>  
 2.5...50 mm<sup>2</sup>  
 15 mm  
 2...3 Nm

IEC61643-11, EN61643-11

#### Dimensions / Signalling contact info

Clamping range (nominal / min. / max.) mm<sup>2</sup>  
 Height x width x depth mm  
 Signalling contact

#### Note

#### no remote sig. contact with remote signalling (R)

no remote sig. contact	with remote signalling (R)
16 / 2.5 / 50	16 / 2.5 / 50
94 / 35.6 / 69	106 / 35.6 / 69
No	250 V 1A 1CO

#### no remote sig. contact with remote signalling (R)

no remote sig. contact	with remote signalling (R)
16 / 2.5 / 50	16 / 2.5 / 50
94 / 17.8 / 69	106 / 17.8 / 69
No	250 V 1A 1CO

### Ordering data

no remote sig. contact  
 with remote signalling (R)

Type	Qty.	Order No.
VPU II 2 75V/30kA	1	1352430000
VPU II 2 R 75V/30kA	1	1352440000

Type	Qty.	Order No.
VPU II 1 75V/30kA	1	1352390000
VPU II 1 R 75V/30kA	1	1352420000

#### Note

### Accessories

#### Note

Pluggable spare arrester VPU II 0 75 V/40 kA-1350530000

Pluggable spare arrester VPU II 0 75 V/40 kA-1350530000





## Type II surge protection

### Type II/III surge protection $U_c$ : 600 V Suitable for 600/1000 V mains systems

- Pluggable arrester
- Coded voltage level
- High energy absorption with short time to sparkover
- Arrester can be rotated through 180°
- No follow-on current
- Installation in distribution board
- Thermal protection function
- Co-ordination with VPU Type I

### VPU II 4/R 600 V / 25 kA

TN-S

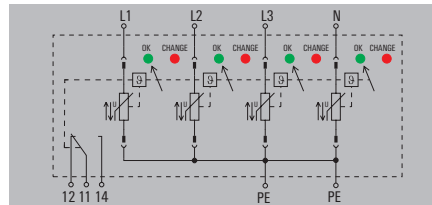

### VPU II 3/R 600 V / 25 kA

TN-C

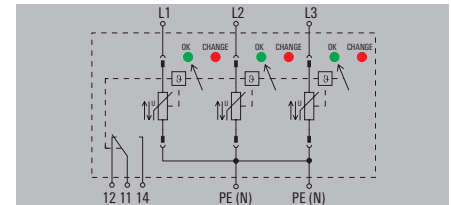

### Technical data

Rated voltage  
Max. continuous voltage,  $U_c$  (AC)  
Requirements category acc. to IEC 61643-11  
Rated discharge current (8/20  $\mu$ s)  $I_n$   
Limiting discharge current (8/20  $\mu$ s)  $I_{max}$   
Discharge current, max. (8/20  $\mu$ s)  
Combined pulse  $U_{oc}$   
Short-circuit resistance  $I_{scCR}$   
Total discharge current  $I_{total}$   
PE conductor current  $I_{PE}$   
Sparkover time / Drop-out time  
Fusing  
Protection level  $U_p$  (typical)  
Temporary surge voltage (over-voltage) - TOV  
Optical function display  
Design  
Colour  
Ambient temperature (operational)  
Storage temperature

#### Connection according to IEC 947-7-1

Solid  
Stranded  
Stripping length  
Tightening torque

#### Approvals

Approvals  
Standards

600 V / 1000 V  
600 V  
Type II, Type III  
12.5 kA  
25 kA  
25 kA  
10 kV  
25 kA  
100 kA  
30  $\mu$ A  
 $\leq 25$  ns  
125 A gL  
 $\leq 2.35$  kV  
820 V  
green = OK; red = arrester is defective - replace  
Installation housing: 4TE, Insta IP 20  
Black, Arrester red  
-40 °C...+70 °C  
-40 °C ... +80 °C

IEC61643-11, EN61643-11

600 V / 1000 V  
600 V  
Type II, Type III  
12.5 kA  
25 kA  
25 kA  
10 kV  
25 kA  
75 kA  
30  $\mu$ A  
 $\leq 25$  ns  
125 A gL  
 $\leq 2.35$  kV  
820 V  
green = OK; red = arrester is defective - replace  
Installation housing: 3TE, Insta IP 20  
Black, Arrester red  
-40 °C...+70 °C  
-40 °C ... +80 °C

IEC61643-11, EN61643-11

#### Dimensions / Signalling contact info

Clamping range (nominal / min. / max.) mm<sup>2</sup>  
Height x width x depth mm  
Signalling contact

#### Note

#### no remote sig. contact with remote signalling (R)

no remote sig. contact	with remote signalling (R)
16 / 2.5 / 50	16 / 2.5 / 50
94 / 71.2 / 69	106 / 71.2 / 69
No	250 V 1A 1CO

#### no remote sig. contact with remote signalling (R)

no remote sig. contact	with remote signalling (R)
16 / 2.5 / 50	16 / 2.5 / 50
94 / 53.4 / 69	106 / 53.4 / 69
No	250 V 1A 1CO

### Ordering data

no remote sig. contact  
with remote signalling (R)

Type	Qty.	Order No.
VPU II 4 600V/25kA	1	1353020000
VPU II 4 R 600V/25kA	1	1351020000

Type	Qty.	Order No.
VPU II 3 600V/25kA	1	1352990000
VPU II 3 R 600V/25kA	1	1353000000

#### Note

### Accessories

#### Note

Pluggable spare arrester VPU II 0 600 V / 40 kA-1352930000

Pluggable spare arrester VPU II 0 600 V / 40 kA-1352930000

**Type II/III surge protection  $U_c$ : 600 V**  
**Suitable for 600/1000 V mains systems**

- Pluggable arrester
- Coded voltage level
- High energy absorption with short time to sparkover
- Arrester can be rotated through 180°
- No follow-on current
- Installation in distribution board
- Thermal protection function
- Co-ordination with VPU Type I

**VPU II 2/R 600 V / 25 kA**

1-phase

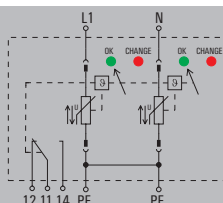

**VPU II 1/R 600 V / 25 kA**

1-phase

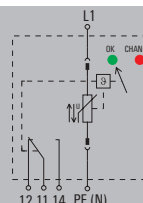

**Technical data**

Rated voltage  
 Max. continuous voltage,  $U_c$  (AC)  
 Requirements category acc. to IEC 61643-11  
 Rated discharge current (8/20  $\mu$ s)  $I_n$   
 Limiting discharge current (8/20  $\mu$ s)  $I_{max}$   
 Discharge current, max. (8/20  $\mu$ s)  
 Combined pulse  $U_{oc}$   
 Short-circuit resistance  $I_{scCR}$   
 Total discharge current  $I_{total}$   
 PE conductor current  $I_{PE}$   
 Sparkover time / Drop-out time  
 Fusing  
 Protection level  $U_p$  (typical)  
 Temporary surge voltage (over-voltage) - TOV  
 Optical function display  
 Design  
 Colour  
 Ambient temperature (operational)  
 Storage temperature

**Connection according to IEC 947-7-1**

Solid  
 Stranded  
 Stripping length  
 Tightening torque

**Approvals**

Approvals  
 Standards

600 V  
 600 V  
 Type II, Type III  
 12.5 kA  
 25 kA  
 25 kA  
 10 kV  
 25 kA  
 50 kA  
 30  $\mu$ A  
 $\leq 25$  ns  
 125 A gL  
 $\leq 2.35$  kV  
 820 V  
 green = OK; red = arrester is defective - replace  
 Installation housing; 2TE, Insta IP 20  
 Black, Arrester red  
 -40 °C...+70 °C  
 -40 °C ... +80 °C

2.5...16 mm<sup>2</sup>  
 2.5...50 mm<sup>2</sup>  
 15 mm  
 2...3 Nm

IEC61643-11, EN61643-11

600 V  
 600 V  
 Type II, Type III  
 12.5 kA  
 25 kA  
 25 kA  
 10 kV  
 25 kA  
 25 kA  
 30  $\mu$ A  
 $\leq 25$  ns  
 125 A gL  
 $\leq 2.35$  kV  
 820 V  
 green = OK; red = arrester is defective - replace  
 Installation housing; 1TE, Insta IP 20  
 Black, Arrester red  
 -40 °C...+70 °C  
 -40 °C ... +80 °C

2.5...16 mm<sup>2</sup>  
 2.5...50 mm<sup>2</sup>  
 15 mm  
 2...3 Nm

IEC61643-11, EN61643-11

**Dimensions / Signalling contact info**

Clamping range (nominal / min. / max.) mm<sup>2</sup>  
 Height x width x depth mm  
 Signalling contact

**Note**

**no remote sig. contact      with remote signalling (R)**

16 / 2.5 / 50	16 / 2.5 / 50
94 / 35.6 / 69	106 / 35.6 / 69
No	250 V 1A 1CO

**no remote sig. contact      with remote signalling (R)**

16 / 2.5 / 50	16 / 2.5 / 50
94 / 17.8 / 69	106 / 17.8 / 69
No	250 V 1A 1CO

**Ordering data**

no remote sig. contact  
 with remote signalling (R)

Type	Qty.	Order No.
VPU II 2 600V/25kA	1	1352970000
VPU II 2 R 600V/25kA	1	1352980000

Type	Qty.	Order No.
VPU II 1 600V/25kA	1	1352940000
VPU II 1 R 600V/25kA	1	1352950000

**Note**

**Accessories**

**Note**

Pluggable spare arrester VPU II 0 600 V / 40 kA-1352930000

Pluggable spare arrester VPU II 0 600 V / 40 kA-1352930000



## Type II surge protection

### Type II/III surge protection $U_c$ : 750 V

#### Suitable for generator protection in wind turbines

- Pluggable arrester
- Coded voltage level
- High energy absorption with short time to sparkover
- Arrester can be rotated through 180°
- No follow-on current
- Installation in distribution board
- Thermal protection function
- Co-ordination with VPU Type I

### VPU II 4/R 750 V / 25 kA

TN-S

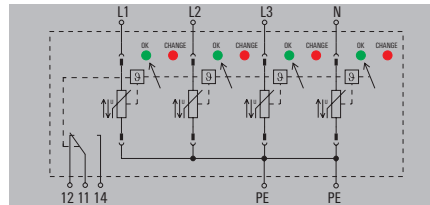

### VPU II 3/R 750 V / 25 kA

TN-C

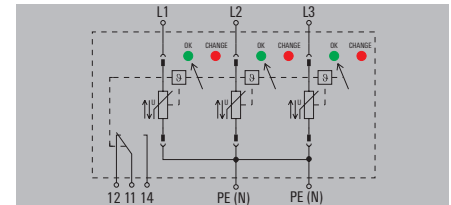

#### Technical data

Rated voltage	460 V
Max. continuous voltage, $U_c$ (AC)	750 V
Requirements category acc. to IEC 61643-11	Type II, Type III
Rated discharge current (8/20 $\mu$ s) $I_n$	12.5 kA
Limiting discharge current (8/20 $\mu$ s) $I_{max}$	25 kA
Discharge current, max. (8/20 $\mu$ s)	25 kA
Combined pulse $U_{oc}$	10 kV
Short-circuit resistance $I_{scCR}$	25 kA
Total discharge current $I_{total}$	100 kA
PE conductor current $I_{PE}$	30 $\mu$ A
Sparkover time / Drop-out time	$\leq 25$ ns
Fusing	125 A gL
Protection level $U_p$ (typical)	$\leq 2.6$ kV
Temporary surge voltage (over-voltage) - TOV	980 V
Optical function display	green = OK; red = arrester is defective - replace
Design	Installation housing: 4TE, Insta IP 20
Colour	Black, Arrester red
Ambient temperature (operational)	-40 °C...+70 °C
Storage temperature	-40 °C...+80 °C

#### Connection according to IEC 947-7-1

Solid	2.5...16 mm <sup>2</sup>
Stranded	2.5...50 mm <sup>2</sup>
Stripping length	15 mm
Tightening torque	2...3 Nm

#### Approvals

Approvals	IEC61643-11, EN61643-11
Standards	

#### Dimensions / Signalling contact info

Clamping range (nominal / min. / max.)	mm <sup>2</sup>
Height x width x depth	mm
Signalling contact	No

#### Note

#### Ordering data

	no remote sig. contact
	with remote signalling (R)

#### Note

#### Accessories

Note	Spare arrester VPU II 0 750V/25kA-1351030000
------	--

Rated voltage	460 V
Max. continuous voltage, $U_c$ (AC)	750 V
Requirements category acc. to IEC 61643-11	Type II, Type III
Rated discharge current (8/20 $\mu$ s) $I_n$	12.5 kA
Limiting discharge current (8/20 $\mu$ s) $I_{max}$	25 kA
Discharge current, max. (8/20 $\mu$ s)	25 kA
Combined pulse $U_{oc}$	10 kV
Short-circuit resistance $I_{scCR}$	25 kA
Total discharge current $I_{total}$	100 kA
PE conductor current $I_{PE}$	30 $\mu$ A
Sparkover time / Drop-out time	$\leq 25$ ns
Fusing	125 A gL
Protection level $U_p$ (typical)	$\leq 2.6$ kV
Temporary surge voltage (over-voltage) - TOV	980 V
Optical function display	green = OK; red = arrester is defective - replace
Design	Installation housing: 3TE, Insta IP 20
Colour	Black, Arrester red
Ambient temperature (operational)	-40 °C...+70 °C
Storage temperature	-40 °C...+80 °C

Solid	2.5...16 mm <sup>2</sup>
Stranded	2.5...50 mm <sup>2</sup>
Stripping length	15 mm
Tightening torque	2...3 Nm

#### Approvals

Approvals	IEC61643-11, EN61643-11
Standards	

#### no remote sig. contact

Clamping range (nominal / min. / max.)	16 / 2.5 / 50
Height x width x depth	106 / 71.2 / 69
Signalling contact	No

#### Note

#### Ordering data

Type	Qty.	Order No.
VPU II 4 750V/25kA	1	1351120000
VPU II 4 R 750V/25kA	1	1351130000

#### Note

#### Accessories

Note	Spare arrester VPU II 0 750V/25kA-1351030000
------	--

Rated voltage	460 V
Max. continuous voltage, $U_c$ (AC)	750 V
Requirements category acc. to IEC 61643-11	Type II, Type III
Rated discharge current (8/20 $\mu$ s) $I_n$	12.5 kA
Limiting discharge current (8/20 $\mu$ s) $I_{max}$	25 kA
Discharge current, max. (8/20 $\mu$ s)	25 kA
Combined pulse $U_{oc}$	10 kV
Short-circuit resistance $I_{scCR}$	25 kA
Total discharge current $I_{total}$	75 kA
PE conductor current $I_{PE}$	30 $\mu$ A
Sparkover time / Drop-out time	$\leq 25$ ns
Fusing	125 A gL
Protection level $U_p$ (typical)	$\leq 2.6$ kV
Temporary surge voltage (over-voltage) - TOV	980 V
Optical function display	green = OK; red = arrester is defective - replace
Design	Installation housing: 3TE, Insta IP 20
Colour	Black, Arrester red
Ambient temperature (operational)	-40 °C...+70 °C
Storage temperature	-40 °C...+80 °C

Solid	2.5...16 mm <sup>2</sup>
Stranded	2.5...50 mm <sup>2</sup>
Stripping length	15 mm
Tightening torque	2...3 Nm

#### Approvals

Approvals	IEC61643-11, EN61643-11
Standards	

#### no remote sig. contact

Clamping range (nominal / min. / max.)	16 / 2.5 / 50
Height x width x depth	106 / 53.4 / 69
Signalling contact	No

#### Note

#### Ordering data

Type	Qty.	Order No.
VPU II 3 750V/25kA	1	1351090000
VPU II 3 R 750V/25kA	1	1351100000

#### Note

#### Accessories

Note	Spare arrester VPU II 0 750V/25kA-1351030000
------	--



**Type II/III surge protection  $U_c$ : 750 V**

**Suitable for generator protection in wind turbines**

- Pluggable arrester
- Coded voltage level
- High energy absorption with short time to sparkover
- Arrester can be rotated through 180°
- No follow-on current
- Installation in distribution board
- Thermal protection function
- Co-ordination with VPU Type I

**VPU II 3+1/R 750 V / 25 kA**

TN-S, TT, IT

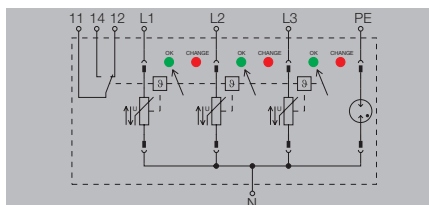

**Technical data**

Rated voltage  
 Max. continuous voltage,  $U_c$  (AC)  
 Requirements category acc. to IEC 61643-11  
 Rated discharge current (8/20  $\mu$ s)  $I_N$   
 Limiting discharge current (8/20  $\mu$ s)  $I_{max}$   
 Discharge current, max. (8/20  $\mu$ s)  
 Combined pulse  $U_{oc}$   
 Short-circuit resistance  $I_{SCCR}$   
 Total discharge current  $I_{total}$   
 PE conductor current  $I_{PE}$   
 Sparkover time / Drop-out time  
 Fusing  
 Protection level  $U_p$  (typical)  
 Temporary surge voltage (over-voltage) - TOV  
 Optical function display  
 Design  
 Colour  
 Ambient temperature (operational)  
 Storage temperature

460 V  
 750 V  
 Type II, Type III  
 12.5 kA  
 25 kA  
 25 kA  
 10 kV  
 25 kA  
 100 kA  
 30  $\mu$ A  
 $\leq 25$  ns,  $\leq 100$  ns  
 125 A gL  
 $\leq 2.6$  kV  
 980 V  
 green = OK; red = arrester is defective - replace  
 Installation housing: 4TE, Insta IP 20  
 Black, Arrester red / blue  
 -40 °C...+70 °C  
 -40 °C ... +80 °C

**Connection according to IEC 947-7-1**

Solid 2.5...16 mm<sup>2</sup>  
 Stranded 2.5...50 mm<sup>2</sup>  
 Stripping length 15 mm  
 Tightening torque 2...3 Nm

**Approvals**

Approvals  
 Standards IEC61643-11, EN61643-11

**Dimensions / Signalling contact info**

Clamping range (nominal / min. / max.) mm<sup>2</sup>  
 Height x width x depth mm  
 Signalling contact

**no remote sig. contact      with remote signalling (R)**

16 / 2.5 / 50      16 / 2.5 / 50  
 94 / 71.2 / 69      106 / 71.2 / 69  
 No      250 V 1A 1CO

**Note**

**Ordering data**

no remote sig. contact  
 with remote signalling (R)

Type	Qty.	Order No.
VPU II 3+1 750V/25kA	1	1351140000
VPU II 3+1 R 750V/25kA	1	1351150000

**Note**

**Accessories**

**Note**  
 Spare arrester L-N VPU II 0 750 V/25 kA-1351030000,  
 N-PE VPU II 0 N-PE 260 V/40 kA-1351180000



## Type II surge protection

### Type II/III surge protection $U_c$ : 750 V

#### Suitable for generator protection in wind turbines

- Pluggable arrester
- Coded voltage level
- High energy absorption with short time to sparkover
- Arrester can be rotated through 180°
- No follow-on current
- Installation in distribution board
- Thermal protection function
- Co-ordination with VPU Type I

### VPU II 2/R 750 V / 25 kA

1-phase

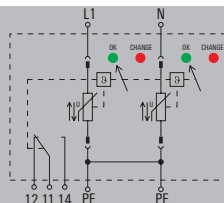

### VPU II 1/R 750 V / 25 kA

1-phase

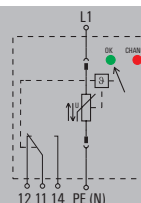

#### Technical data

Rated voltage	460 V
Max. continuous voltage, $U_c$ (AC)	750 V
Requirements category acc. to IEC 61643-11	Type II, Type III
Rated discharge current (8/20 $\mu$ s) $I_n$	12.5 kA
Limiting discharge current (8/20 $\mu$ s) $I_{max}$	25 kA
Discharge current, max. (8/20 $\mu$ s)	25 kA
Combined pulse $U_{oc}$	10 kV
Short-circuit resistance $I_{scCR}$	25 kA
Total discharge current $I_{total}$	50 kA
PE conductor current $I_{PE}$	30 $\mu$ A
Sparkover time / Drop-out time	$\leq 25$ ns
Fusing	125 A gL
Protection level $U_p$ (typical)	$\leq 2.6$ kV
Temporary surge voltage (over-voltage) - TOV	980 V
Optical function display	green = OK; red = arrester is defective - replace
Design	Installation housing; 2TE, Insta IP 20
Colour	Black, Arrester red
Ambient temperature (operational)	-40 °C...+70 °C
Storage temperature	-40 °C ... +80 °C
<b>Connection according to IEC 947-7-1</b>	
Solid	2.5...16 mm <sup>2</sup>
Stranded	2.5...50 mm <sup>2</sup>
Stripping length	15 mm
Tightening torque	2...3 Nm
<b>Approvals</b>	
Approvals	
Standards	IEC61643-11, EN61643-11

Rated voltage	460 V
Max. continuous voltage, $U_c$ (AC)	750 V
Requirements category acc. to IEC 61643-11	Type II, Type III
Rated discharge current (8/20 $\mu$ s) $I_n$	12.5 kA
Limiting discharge current (8/20 $\mu$ s) $I_{max}$	25 kA
Discharge current, max. (8/20 $\mu$ s)	25 kA
Combined pulse $U_{oc}$	10 kV
Short-circuit resistance $I_{scCR}$	25 kA
Total discharge current $I_{total}$	50 kA
PE conductor current $I_{PE}$	30 $\mu$ A
Sparkover time / Drop-out time	$\leq 25$ ns
Fusing	125 A gL
Protection level $U_p$ (typical)	$\leq 2.6$ kV
Temporary surge voltage (over-voltage) - TOV	980 V
Optical function display	green = OK; red = arrester is defective - replace
Design	Installation housing; 1TE, Insta IP 20
Colour	Black, Arrester red
Ambient temperature (operational)	-40 °C...+70 °C
Storage temperature	-40 °C ... +80 °C
<b>Connection according to IEC 947-7-1</b>	
Solid	2.5...16 mm <sup>2</sup>
Stranded	2.5...50 mm <sup>2</sup>
Stripping length	15 mm
Tightening torque	2...3 Nm
<b>Approvals</b>	
Approvals	
Standards	IEC61643-11, EN61643-11

Rated voltage	460 V
Max. continuous voltage, $U_c$ (AC)	750 V
Requirements category acc. to IEC 61643-11	Type II, Type III
Rated discharge current (8/20 $\mu$ s) $I_n$	12.5 kA
Limiting discharge current (8/20 $\mu$ s) $I_{max}$	25 kA
Discharge current, max. (8/20 $\mu$ s)	25 kA
Combined pulse $U_{oc}$	10 kV
Short-circuit resistance $I_{scCR}$	25 kA
Total discharge current $I_{total}$	25 kA
PE conductor current $I_{PE}$	30 $\mu$ A
Sparkover time / Drop-out time	$\leq 25$ ns
Fusing	125 A gL
Protection level $U_p$ (typical)	$\leq 2.6$ kV
Temporary surge voltage (over-voltage) - TOV	980 V
Optical function display	green = OK; red = arrester is defective - replace
Design	Installation housing; 1TE, Insta IP 20
Colour	Black, Arrester red
Ambient temperature (operational)	-40 °C...+70 °C
Storage temperature	-40 °C ... +80 °C
<b>Connection according to IEC 947-7-1</b>	
Solid	2.5...16 mm <sup>2</sup>
Stranded	2.5...50 mm <sup>2</sup>
Stripping length	15 mm
Tightening torque	2...3 Nm
<b>Approvals</b>	
Approvals	
Standards	IEC61643-11, EN61643-11

Dimensions / Signalling contact info	
Clamping range (nominal / min. / max.)	mm <sup>2</sup>
Height x width x depth	mm
Signalling contact	
<b>Note</b>	

	no remote sig. contact	with remote signalling (R)
Clamping range	16 / 2.5 / 50	16 / 2.5 / 50
Height x width x depth	94 / 35.6 / 69	106 / 35.6 / 69
Signalling contact	No	250 V 1A 1CO
<b>Note</b>		

	no remote sig. contact	with remote signalling (R)
Clamping range	16 / 2.5 / 50	16 / 2.5 / 50
Height x width x depth	94 / 17.8 / 69	106 / 17.8 / 69
Signalling contact	No	250 V 1A 1CO
<b>Note</b>		

#### Ordering data

Type	Qty.	Order No.
VPU II 2 750V/25kA	1	1351070000
VPU II 2 R 750V/25kA	1	1351080000
<b>Note</b>		

Type	Qty.	Order No.
VPU II 1 750V / 25kA	1	1351040000
VPU II 1 R 750V/25kA	1	1351050000
<b>Note</b>		

Type	Qty.	Order No.
VPU II 1 750V / 25kA	1	1351040000
VPU II 1 R 750V/25kA	1	1351050000
<b>Note</b>		

#### Accessories

<b>Note</b>	
-------------	--

Spare arrester VPU II 0 750V/25kA-1351030000
--

Spare arrester VPU II 0 750V/25kA-1351030000
--





# DC surge protection for photovoltaic facilities

For the DC voltage side, Weidmüller offers complete protection with a comprehensive range of surge arresters.

For cable lengths of more than 10 m between the PV generator and the inverter, protection is needed at both ends. This means that both the generators and the inverter are protected.

Lightning and surge protection for low voltage facilities

C



### External lightning protection available

And the separation distances are observed (Type II)

### External lightning protection not available

(Type II)

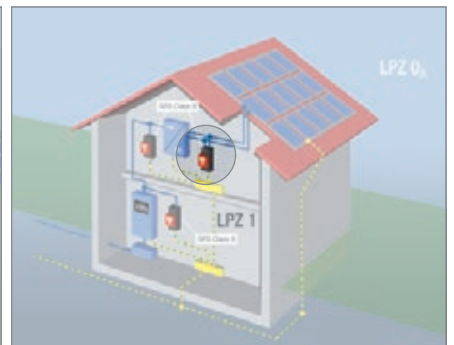
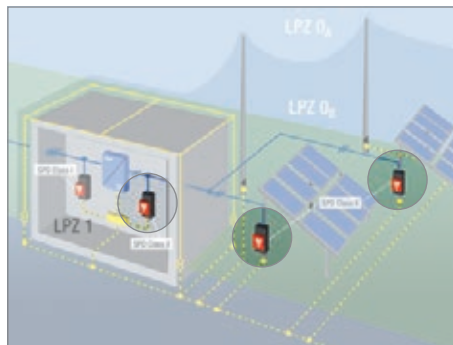
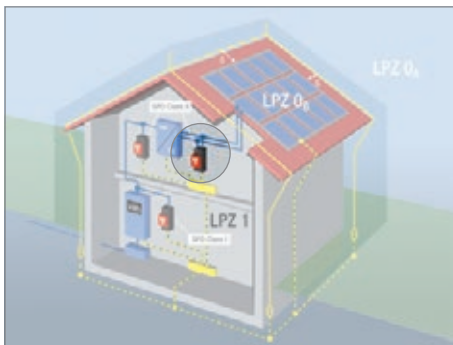

VPU II 3/R 1.000 V DC PV



### Failure to comply with the separation distance S

If the separation distance  $S$  according to EN 62305 is not observed ( $S < \min$ ), then partial lightning currents need to be taken into account. A shielded generator main line with sufficient cross-sectional area (min.  $16 \text{ mm}^2$ ) should be used. The adjacent picture shows an implementation that reaches LPZ 1. Here the surge protection from the Class II arrester can be installed in line with the existing standards (product selection, see above). Another alternative is type I lightning and surge protection, especially for plants where the separation distance cannot be observed, e.g. installation on tin roofs.

### Ready-made standard solutions

Weidmüller offers an extensive range of combiner boxes with overvoltage protection for the DC side. It comprises solutions pre-wired for 1 to 16 string applications in various versions.

Our Photovoltaic Catalogue (order number 1344440000) contains a **complete list** of our standard solutions.

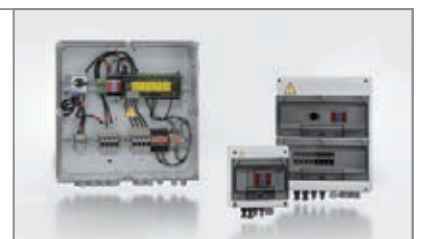

**Type I and II lightning arrester for use in photovoltaic applications**

- Suitable for lightning protection level III and IV (LPL III/IV)
- Can also be used as Type II surge protection
- Tested in accordance with EN 50539-11
- Suitable for use in accordance with IEC 60364-7-712/EN 50539-12
- Use if the separation distance cannot be observed

**VPU I 2+0 PV 600 V**

Photovoltaics

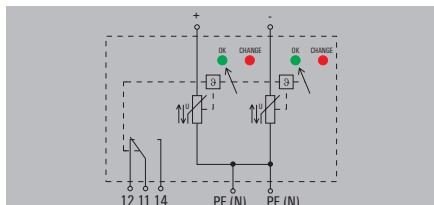

**VPU I 2+0 PV 1000 V**

Photovoltaics

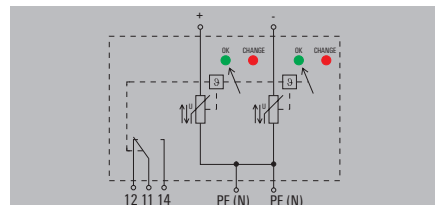

**Technical data**

Max. continuous voltage,  $U_c$  (DC)  
 Requirements class  
 Lightning test current  $I_{imp}$  (10/350  $\mu$ s)  
 Discharge current, max. (8/20  $\mu$ s)  
 Rated discharge current (8/20  $\mu$ s)  $I_n$   
 PV voltage, acc. to IEC 60364-7-712  
 Discharge current, nominal, per path, (8/20  $\mu$ s)  
 PE conductor current  $I_{PE}$   
 Sparkover time / Drop-out time  
 Optical function display  
 Design  
 Colour  
 Ambient temperature (operational)  
 Storage temperature

**Connection according to IEC 947-7-1**

Solid  
 Stranded  
 Stripping length  
 Tightening torque

**Technical data - photovoltaic**

Maximum continuous operating voltage UCPV mode +/-, -/PE, +/-PE  
 Protection level  $U_p$  mode (+/-, -/PE, +/-PE)  
 Conditions and requirements  
 Short circuit protection  $I_{scpv}$   
 Protection level  $U_p$  at  $I_n$  (per module)  
 PV system voltage, max.  $U_{cpv}$

**Approvals**

Approvals  
 Standards

**Dimensions**

Clamping range (nominal / min. / max.) mm<sup>2</sup>  
 Height x width x depth mm  
 Signalling contact

**Note**

**Ordering data**

no remote sig. contact  
 with remote signalling (R)

**Note**

**Accessories**

**Note**

600 V  
 Type I, Type II / T1, T2  
 12.5 kA  
 40 kA  
 20 kA  
 < 600 V  
 20 kA  
 30  $\mu$ A  
 $\leq 25$  ns  
 green = OK; red = arrester is defective - replace  
 Installation housing; 4TE, Insta IP 20  
 Black  
 -40 °C...+70 °C  
 -40 °C...+80 °C

2.5...16 mm<sup>2</sup>  
 2.5...50 mm<sup>2</sup>  
 15 mm  
 2...3 Nm

600 V DC  
 $\leq 1.8$  kV  
 EN 50539-11  
 50 A  
 $\leq 1.8$  kV  
 600 V

EN 50539-11

no remote sig. contact	with remote signalling (R)
16 / 4 / 50	16 / 4 / 50
94 / 71.2 / 69	106 / 71.2 / 69
No	250 V 1A 1CO

Type	Qty.	Order No.
VPU I 2+0 PV 600V DC	1	1351520000
VPU I 2+0 R PV 600V DC	1	1351490000

1000 V  
 Type I, Type II / T1, T2  
 12.5 kA  
 40 kA  
 20 kA  
 $\leq 1000$  V  
 20 kA  
 30  $\mu$ A  
 $\leq 25$  ns  
 green = OK; red = arrester is defective - replace  
 Installation housing; 4TE, Insta IP 20  
 Black  
 -40 °C...+70 °C  
 -40 °C...+80 °C

2.5...16 mm<sup>2</sup>  
 2.5...50 mm<sup>2</sup>  
 15 mm  
 2...3 Nm

1000 V DC  
 $\leq 2.6$  kV  
 EN 50539-11  
 50 A  
 $\leq 2.6$  kV  
 1000 V

EN 50539-11

no remote sig. contact	with remote signalling (R)
16 / 4 / 50	16 / 4 / 50
94 / 71.2 / 69	106 / 71.2 / 69
No	250 V 1A 1CO

Type	Qty.	Order No.
VPU I 2+0 PV 1000V DC	1	1351470000
VPU I 2+0 R PV 1000V DC	1	1351430000



**Type II surge voltage arrester for use in photovoltaic applications**

- Pluggable arrester
- Suitable for protecting DC systems as Type II arrester
- Encapsulated, non-blow-out arrester
- Tested in accordance with EN 50539-11
- Pluggable arresters
- Suitable for use in accordance with IEC 60364-7-712 / EN 50539-12
- Use if the separation distance can be observed

**VPU II 2 PV/R 1000 V**

Photovoltaics

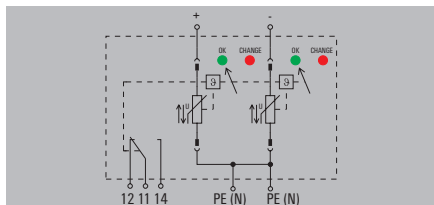

**VPU II 3 PV/R 1000 V**

Photovoltaics

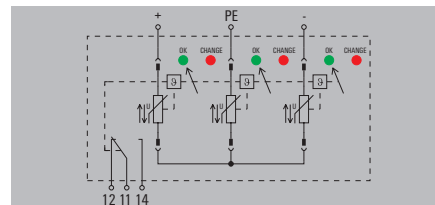

**Technical data**

Max. continuous voltage, U <sub>c</sub> (DC)	1000 V
Requirements class	Type II / T2
Discharge current, max. (8/20 µs)	25 kA
Rated discharge current (8/20 µs) I <sub>n</sub>	12.5 kA
PV voltage, acc. to IEC 60364-7-712	≤ 1000 V
Discharge current, nominal, per path, (8/20 µs)	12.5 kA
PE conductor current I <sub>PE</sub>	30 µA
Sparkover time / Drop-out time	≤ 25 ns
Optical function display	green = OK; red = arrester is defective - replace
Design	Installation housing; 2TE, Insta IP 20
Colour	Black, Arrester red
Ambient temperature (operational)	-40 °C...+70 °C
Storage temperature	-40 °C ... +80 °C

<b>Connection according to IEC 947-7-1</b>	
Solid	2.5...16 mm <sup>2</sup>
Stranded	2.5...50 mm <sup>2</sup>
Stripping length	15 mm
Tightening torque	2...3 Nm

<b>Technical data - photovoltaic</b>	
Maximum continuous operating voltage U <sub>CPV</sub> mode +/-, -/PE, +/-PE	1000 V DC
Protection level U <sub>p</sub> mode (+/-, -/PE, +/-PE)	≤ 2.8 kV
Conditions and requirements	EN 50539-11
Short circuit protection I <sub>scpv</sub>	50 A
Protection level U <sub>p</sub> at I <sub>scpv</sub> (per module)	≤ 2.8 kV
PV system voltage, max. U <sub>cpv</sub>	1000 V

<b>Approvals</b>	
Approvals	
Standards	EN 50539-11

<b>Dimensions</b>	
Clamping range (nominal / min. / max.)	mm <sup>2</sup>
Height x width x depth	mm
Signalling contact	No
<b>Note</b>	

**Ordering data**

	no remote sig. contact
	with remote signalling (R)
<b>Note</b>	

**Accessories**

<b>Note</b>	Pluggable spare arrester VPU II 0 PV 1,000 V-1351190000
-------------	---

Max. continuous voltage, U <sub>c</sub> (DC)	1000 V
Requirements class	Type II / T2
Discharge current, max. (8/20 µs)	40 kA
Rated discharge current (8/20 µs) I <sub>n</sub>	25 kA
PV voltage, acc. to IEC 60364-7-712	≤ 1000 V
Discharge current, nominal, per path, (8/20 µs)	20 kA
PE conductor current I <sub>PE</sub>	30 µA
Sparkover time / Drop-out time	≤ 25 ns
Optical function display	green = OK; red = arrester is defective - replace
Design	Installation housing; 3TE, Insta IP 20
Colour	Black, Arrester red
Ambient temperature (operational)	-40 °C...+70 °C
Storage temperature	-40 °C ... +80 °C

<b>Connection according to IEC 947-7-1</b>	
Solid	2.5...16 mm <sup>2</sup>
Stranded	2.5...50 mm <sup>2</sup>
Stripping length	15 mm
Tightening torque	2...3 Nm

<b>Technical data - photovoltaic</b>	
Maximum continuous operating voltage U <sub>CPV</sub> mode +/-, -/PE, +/-PE	1000 V DC
Protection level U <sub>p</sub> mode (+/-, -/PE, +/-PE)	≤ 4.0 kV
Conditions and requirements	EN 50539-11
Short circuit protection I <sub>scpv</sub>	50 A
Protection level U <sub>p</sub> at I <sub>scpv</sub> (per module)	≤ 4.0 kV
PV system voltage, max. U <sub>cpv</sub>	1000 V

<b>Approvals</b>	
Approvals	
Standards	EN 50539-11

<b>Dimensions</b>	
Clamping range (nominal / min. / max.)	mm <sup>2</sup>
Height x width x depth	mm
Signalling contact	No
<b>Note</b>	

Type	Qty.	Order No.
VPU II 2 PV 1000V DC	1	1351220000
VPU II 2 R PV 1000V DC	1	1351240000

<b>Note</b>	Pluggable spare arrester VPU II 0 PV 1,000 V-1351190000
-------------	---

Max. continuous voltage, U <sub>c</sub> (DC)	1000 V
Requirements class	Type II / T2
Discharge current, max. (8/20 µs)	40 kA
Rated discharge current (8/20 µs) I <sub>n</sub>	25 kA
PV voltage, acc. to IEC 60364-7-712	≤ 1000 V
Discharge current, nominal, per path, (8/20 µs)	20 kA
PE conductor current I <sub>PE</sub>	30 µA
Sparkover time / Drop-out time	≤ 25 ns
Optical function display	green = OK; red = arrester is defective - replace
Design	Installation housing; 3TE, Insta IP 20
Colour	Black, Arrester red
Ambient temperature (operational)	-40 °C...+70 °C
Storage temperature	-40 °C ... +80 °C

<b>Connection according to IEC 947-7-1</b>	
Solid	2.5...16 mm <sup>2</sup>
Stranded	2.5...50 mm <sup>2</sup>
Stripping length	15 mm
Tightening torque	2...3 Nm

<b>Technical data - photovoltaic</b>	
Maximum continuous operating voltage U <sub>CPV</sub> mode +/-, -/PE, +/-PE	1000 V DC
Protection level U <sub>p</sub> mode (+/-, -/PE, +/-PE)	≤ 4.0 kV
Conditions and requirements	EN 50539-11
Short circuit protection I <sub>scpv</sub>	50 A
Protection level U <sub>p</sub> at I <sub>scpv</sub> (per module)	≤ 4.0 kV
PV system voltage, max. U <sub>cpv</sub>	1000 V

<b>Approvals</b>	
Approvals	
Standards	EN 50539-11

<b>Dimensions</b>	
Clamping range (nominal / min. / max.)	mm <sup>2</sup>
Height x width x depth	mm
Signalling contact	No
<b>Note</b>	

Type	Qty.	Order No.
VPU II 3 PV 1000V DC	1	1351270000
VPU II 3 R PV 1000V DC	1	1351290000

<b>Note</b>	Pluggable spare arrester VPU II 0 PV Y 1,000 V-1375440000
-------------	---



**Type II surge voltage arrester for use in photovoltaic applications**

- Pluggable arrester
- Suitable for protecting DC systems as Type II arrester
- Encapsulated, non-blow-out arrester
- Tested in accordance with EN 50539-11
- Pluggable arresters
- Suitable for use in accordance with IEC 60364-7-712 / EN 50539-12
- Use if the separation distance can be observed

**VPU II 2 PV/R 600 V**

Photovoltaics

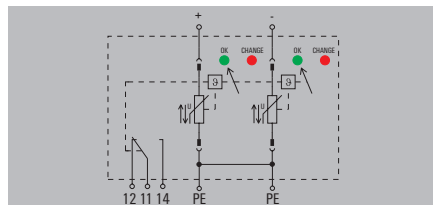

**VPU II 3 PV/R 1200 V**

Photovoltaics

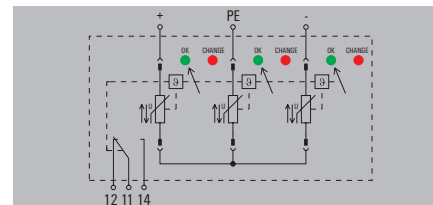

**Technical data**

Max. continuous voltage,  $U_c$  (DC)  
 Requirements class  
 Discharge current, max. (8/20  $\mu$ s)  
 Rated discharge current (8/20  $\mu$ s)  $I_n$   
 PV voltage, acc. to IEC 60364-7-712  
 Discharge current, nominal, per path, (8/20  $\mu$ s)  
 PE conductor current  $I_{PE}$   
 Sparkover time / Drop-out time  
 Optical function display  
 Design  
 Colour  
 Ambient temperature (operational)  
 Storage temperature

**Connection according to IEC 947-7-1**

Solid  
 Stranded  
 Stripping length  
 Tightening torque

**Technical data - photovoltaic**

Maximum continuous operating voltage UCPV mode +/-, -/PE, +/-PE  
 Protection level  $U_p$ , mode (+/-, -/PE, +/-PE)  
 Conditions and requirements  
 Short circuit protection  $I_{scpv}$   
 Protection level  $U_p$  at  $I_{scpv}$  (per module)  
 PV system voltage, max.  $U_{cpv}$

**Approvals**

Approvals  
 Standards

**Dimensions**

Clamping range (nominal / min. / max.) mm<sup>2</sup>  
 Height x width x depth mm  
 Signalling contact

**Note**

**Ordering data**

no remote sig. contact  
 with remote signalling (R)

**Note**

**Accessories**

**Note**

600 V  
 Type II / T2  
 40 kA  
 20 kA  
 < 600 V  
 20 kA  
 30  $\mu$ A  
 $\leq 25$  ns  
 green = OK; red = arrester is defective - replace  
 Installation housing; 2TE, Insta IP 20  
 Black, Arrester red  
 -40 °C...+70 °C  
 -40 °C ... +80 °C

2.5...16 mm<sup>2</sup>  
 2.5...50 mm<sup>2</sup>  
 15 mm  
 2...3 Nm

600 V DC  
 $\leq 2.2$  kV  
 EN 50539-11  
 50 A  
 $\leq 2.2$  kV  
 600 V

EN 50539-11

no remote sig. contact	with remote signalling (R)
16 / 2.5 / 50	16 / 2.5 / 50
94 / 35.6 / 69	106 / 35.6 / 69
No	250 V 1 A 1 NC

Type	Qty.	Order No.
VPU II 2 PV 600V DC	1	1351340000
VPU II 2 R PV 600V DC	1	1351370000

Pluggable spare arrester VPU II 0 PV 600 V-1351320000

1200 V  
 Type II / T2  
 40 kA  
 20 kA  
 < 1200 V  
 20 kA  
 30  $\mu$ A  
 $\leq 25$  ns  
 green = OK; red = arrester is defective - replace  
 Installation housing; 3TE, Insta IP 20  
 Black, Arrester red  
 -40 °C...+70 °C  
 -40 °C ... +80 °C

2.5...16 mm<sup>2</sup>  
 2.5...50 mm<sup>2</sup>  
 15 mm  
 2...3 Nm

1200 V DC  
 $\leq 4.4$  kV  
 EN 50539-11  
 50 A  
 $\leq 4.4$  kV  
 1200 V

EN 50539-11

no remote sig. contact	with remote signalling (R)
16 / 2.5 / 50	16 / 2.5 / 50
94 / 53.4 / 69	106 / 53.4 / 69
No	250 V 1 A 1 NC

Type	Qty.	Order No.
VPU II 3 PV 1200V DC	1	1351420000
VPU II 3 R PV 1200V DC	1	1351440000

Pluggable spare arrester VPU II 0 PV 1,200 V-1351390000



**Type II surge voltage arrester for use in photovoltaic applications**

- Pluggable arrester
- Suitable for protecting DC systems as Type II arrester
- Encapsulated, non-blow-out arrester
- Tested in accordance with EN 50539-11
- Pluggable arresters
- Suitable for use in accordance with IEC 60364-7-712 / EN 50539-12
- Use if the separation distance can be observed

**VPU II 3 PV/R 1500 V**

Photovoltaics

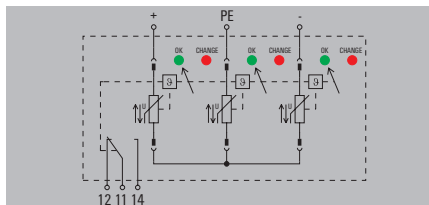

**Technical data**

Max. continuous voltage,  $U_c$  (DC)  
 Requirements class  
 Discharge current, max. (8/20  $\mu$ s)  
 Rated discharge current (8/20  $\mu$ s)  $I_n$   
 PV voltage, acc. to IEC 60364-7-712  
 Discharge current, nominal, per path, (8/20  $\mu$ s)  
 PE conductor current  $I_{PE}$   
 Sparkover time / Drop-out time  
 Optical function display  
 Design  
 Colour  
 Ambient temperature (operational)  
 Storage temperature

**Connection according to IEC 947-7-1**

Solid  
 Stranded  
 Stripping length  
 Tightening torque

**Technical data - photovoltaic**

Maximum continuous operating voltage UCPV mode +/-, -/PE, +/-PE  
 Protection level  $U_p$ , mode (+/-, -/PE, +/-PE)  
 Conditions and requirements  
 Short circuit protection  $I_{scpv}$   
 Protection level  $U_p$  at  $I_s$  (per module)  
 PV system voltage, max.  $U_{cpv}$

**Approvals**

Approvals  
 Standards

1500 V  
 Type II / T2  
 25 kA  
 12.5 kA  
 < 1500 V  
 12.5 kA  
 30  $\mu$ A  
 $\leq 25$  ns  
 green = OK; red = arrester is defective - replace  
 Installation housing: 3TE, Insta IP 20  
 Black, Arrester red  
 -40 °C...+70 °C  
 -40 °C ... +80 °C

2.5...16 mm<sup>2</sup>  
 2.5...50 mm<sup>2</sup>  
 15 mm  
 2...3 Nm  
 1500 V DC  
 $\leq 5.2$  kV  
 EN 50539-11  
 50 A  
 $\leq 5.2$  kV  
 1500 V  
 EN 50539-11

**Dimensions**

Clamping range (nominal / min. / max.) mm<sup>2</sup>  
 Height x width x depth mm  
 Signalling contact

**Note**

no remote sig. contact	with remote signalling (R)
16 / 2.5 / 50	16 / 2.5 / 50
94 / 53.4 / 69	106 / 53.4 / 69
No	250 V 1 A 1 NC

**Ordering data**

no remote sig. contact  
 with remote signalling (R)

Type	Qty.	Order No.
VPU II 3 PV 1500V DC	1	1351500000
VPU II 3 R PV 1500V DC	1	1351530000

**Note**

**Accessories**

Note  
 Pluggable spare arrester VPU II 0 PV 1,500 V-1351480000





## Type III surge protection for end devices

### Low-voltage consumer installations, small distribution units and electronics

Surge protection module type III

Our surge protection modules VPU III and VPO DS protect low voltage consumer installations and electronic devices from voltage surges that occur through atmospheric discharge (lightning) or switching activities (transients). The VPU III and the VPO DS can be built into small distribution boards or into multi-floor distribution boards. The VPU III satisfies the requirements of IEC 61643-11.

### Functional check and maintenance

Varistors can exhibit high temperatures as a result of ageing. In low-voltage systems, this can result in fire. The integrated temperature monitoring device automatically disconnects the varistor from the power supply. This disconnection is indicated by the warning lamp being extinguished. With the VPU III type, a switch contact is also fitted for signalling. With the VPO DS, an LED is used to indicate status and with the VPO ADS a buzzer highlights any error messages.

The back-up fuse you install depends on the conductor cross-section and type of routing. For VPU III arresters, the maximum power rating is 16 A. The connection is rated to IEC 947-7-1 for the following cross-sections:  
solid conductor: 0.5...2.5 mm<sup>2</sup>  
flexible conductor: 0.5...2.5 mm<sup>2</sup>



### Electrical connection

The VPU III or VPO DS surge protection device is installed after the VPU II arrester and before the device / consumer to be protected. It can protect electrical circuits of up to 16 A. An installation can be done in a consumer unit for an electrical circuit that protects monitors, for example..

**Dimensioned drawing VPU III**

Overall width 18 mm

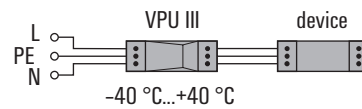
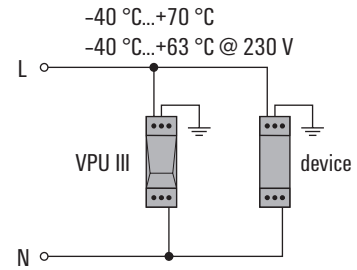
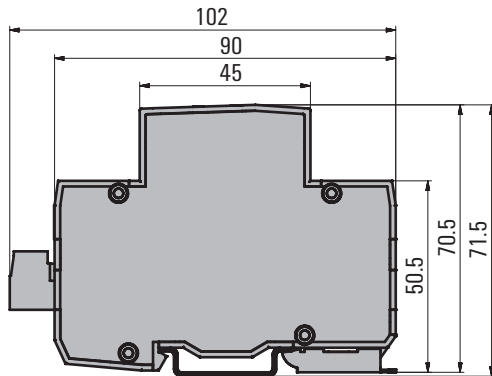

The standard implementation for operating the VPU III products is a series connection to the end device. Under this operational state, the protective device can bear a long-term load of 16 A. For higher demands, parallel circuitry is used

# VPU III surge protection for terminal devices

## Maximum type III protection from surges

This product line provides an integrated protective strategy for surge protection for end devices. Rail-based mounting installations are especially important for industrial applications. For this reason, the housing design has been adapted to the standardised installation dimensions. The VPU III has a wide array of available functions. A status signal and a connection for the floating contact make the unit easy to service. A defective device can easily be swapped out because of the plug-in connectors. The VPU III covers all standard nominal voltages in the power range: 12 V, 24 V, 48 V, 120 V and 230 V.

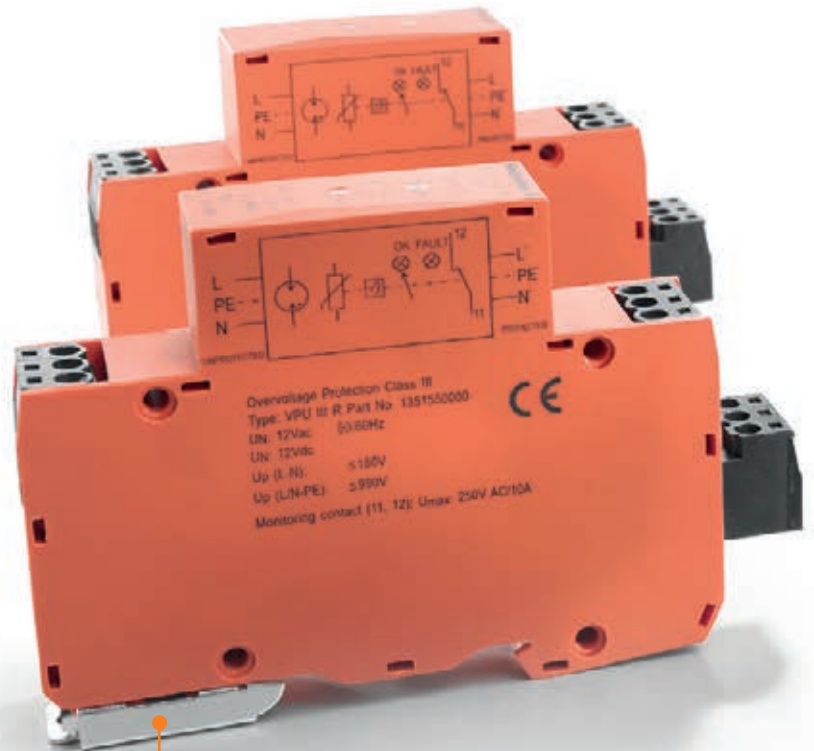

### Faster to assemble

The optimised mounting rail clip enables easy and quick installation, without the need for tools.



**Best overview**

LEDs provide clearly visible information on the status of the protective function



**Rapid status messaging**

The remote signaling contact provides reliable information regarding the status of the protective function

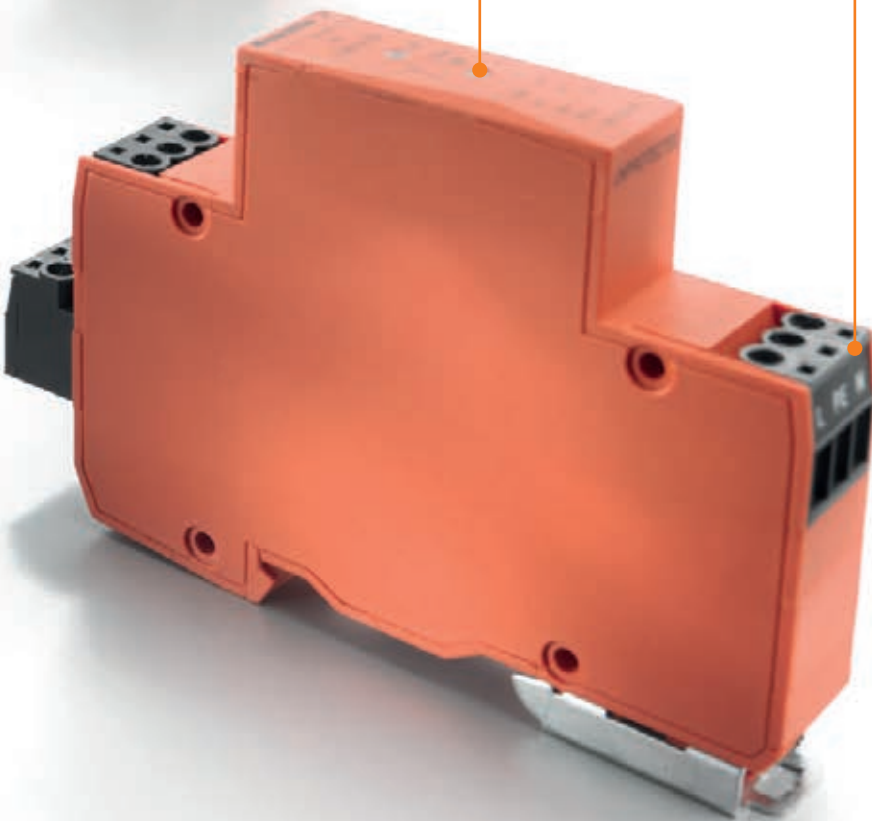

Type III with varistors / gas discharge tube

- Type III surge protection
- Suitable for protecting terminals
- Installed in the vicinity of the equipment to be protected
- For mounting on TS35 rail
- Arrester with remote signalling contact
- Tested in accordance with IEC 61643-11

VPU III R 230 V / 6 kV

For use as device protector

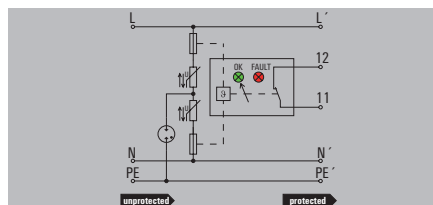

VPU III R 120 V / 6 kV

For use as device protector

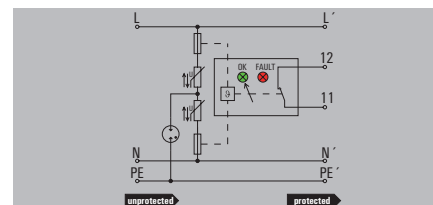

Technical data

Rated voltage (AC)  
 Rated voltage (DC)  
 Max. continuous voltage,  $U_c$  (AC)  
 Max. continuous voltage,  $U_c$  (DC)  
 Requirements category acc. to IEC 61643-11  
 Combined pulse  $U_{oc}$   
 Rated discharge current (8/20  $\mu$ s)  $I_n$   
 Short-circuit resistance  $I_{scR}$   
 Discharge current, max. (8/20  $\mu$ s)  
 Rated load current  $I_L$   
 PE conductor current  $I_{PE}$   
 Sparkover time / Drop-out time  
 Fusing  
 Protection level  $U_p$  (typical)  
 Temporary surge voltage (over-voltage) - TOV  
 Optical function display  
 Design  
 Ambient temperature (operational)  
 Storage temperature

Connection according to IEC 947-7-1

Solid  
 Stranded  
 Stripping length  
 Tightening torque

Approvals

Approvals  
 Standards

230 V  
 300 V  
 Type III  
 3 kV  
 1.5 kA  
 3 kA  
 16 A  
 0  $\mu$ A  
 < 100 ns  
 16 A  
 $\leq 1.8$  kV  
 440 V  
 Green LED = OK, LED red = arrester faulty, replace  
 Installation housing; 1TE, Insta IP 20  
 -40 °C...+70 °C  
 -40°C ... +80°C

0.5...2.5 mm<sup>2</sup>  
 0.5...2.5 mm<sup>2</sup>  
 7 mm  
 0.4...0.5 Nm

IEC61643-11, EN61643-11

120 V  
 150 V  
 212 V  
 180 V  
 Type III  
 3 kV  
 1.5 kA  
 3 kA  
 16 A  
 0  $\mu$ A  
 < 100 ns  
 16 A  
 $\leq 1.75$  kV  
 228 V  
 Green LED = OK, LED red = arrester faulty, replace  
 Installation housing; 1TE, Insta IP 20  
 -40 °C...+70 °C  
 -40°C ... +80°C

0.5...2.5 mm<sup>2</sup>  
 0.5...2.5 mm<sup>2</sup>  
 7 mm  
 0.4...0.5 Nm

IEC61643-11, EN61643-11

Dimensions / Signalling contact info

Clamping range (nominal / min. / max.) mm<sup>2</sup>  
 Height x width x depth mm  
 Signalling contact

Note

Screw connection

2.5 / 0.5 / 2.5  
 102 / 18 / 71.5  
 250 V 1 A 1 NC

Screw connection

2.5 / 0.5 / 2.5  
 102 / 18 / 71.5  
 250 V 1 A 1 NC

Ordering data

Screw connection

Type	Qty.	Order No.
VPU III R 230V/6KV AC	1	1351650000

Type	Qty.	Order No.
VPU III R 120V/6KV AC/DC	1	1351630000

Note

Accessories

Note

**Type III with varistors / gas discharge tube**

- Type III surge protection
- Suitable for protecting terminals
- Installed in the vicinity of the equipment to be protected
- For mounting on TS35 rail
- Arrester with remote signalling contact
- Tested in accordance with IEC 61643-11

**VPU III R 48 V / 4 kV**

For use as device protector

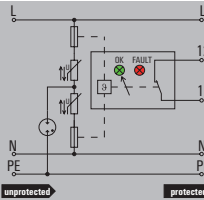

**VPU III R 24 V / 4 kV**

For use as device protector

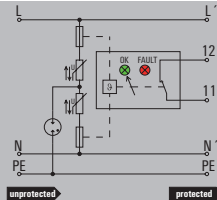

**Technical data**

Rated voltage (AC)  
 Rated voltage (DC)  
 Max. continuous voltage, U<sub>c</sub> (AC)  
 Max. continuous voltage, U<sub>c</sub> (DC)  
 Requirements category acc. to IEC 61643-11  
 Combined pulse U<sub>dc</sub>  
 Rated discharge current (8/20 μs) I<sub>w</sub>  
 Short-circuit resistance I<sub>scCR</sub>  
 Discharge current, max. (8/20 μs)  
 Rated load current I<sub>L</sub>  
 PE conductor current I<sub>PE</sub>  
 Sparkover time / Drop-out time  
 Fusing  
 Protection level U<sub>p</sub> (typical)  
 Temporary surge voltage (over-voltage) - TOV  
 Optical function display  
 Design  
 Ambient temperature (operational)  
 Storage temperature

**Connection according to IEC 947-7-1**

Solid  
 Stranded  
 Stripping length  
 Tightening torque

**Approvals**

Approvals  
 Standards

48 V  
 70 V  
 50 V  
 72 V  
 Type III  
 2 kV  
 1.5 kA  
 2 kA  
 16 A  
 0 μA  
 < 100 ns  
 16 A  
 ≤ 950 V  
 91 V  
 Green LED = OK, LED red = arrester faulty, replace  
 Installation housing; 1TE, Insta IP 20  
 -40 °C...+70 °C  
 -40°C ... +80°C

0.5...2.5 mm<sup>2</sup>  
 0.5...2.5 mm<sup>2</sup>  
 7 mm  
 0.4...0.5 Nm  
 IEC61643-11, EN61643-11

24 V  
 32 V  
 32 V  
 53 V  
 Type III  
 2 kV  
 1.5 kA  
 2 kA  
 16 A  
 0 μA  
 < 100 ns  
 16 A  
 ≤ 890 V  
 45 V  
 Green LED = OK, LED red = arrester faulty, replace  
 Installation housing; 1TE, Insta IP 20  
 -40 °C...+70 °C  
 -40°C ... +80°C

0.5...2.5 mm<sup>2</sup>  
 0.5...2.5 mm<sup>2</sup>  
 7 mm  
 0.4...0.5 Nm  
 IEC61643-11, EN61643-11

**Dimensions / Signalling contact info**

Clamping range (nominal / min. / max.) mm<sup>2</sup>  
 Height x width x depth mm  
 Signalling contact

**Note**

**Screw connection**

2.5 / 0.5 / 2.5  
 102 / 18 / 71.5  
 250 V 1 A 1 NC

**Screw connection**

2.5 / 0.5 / 2.5  
 102 / 18 / 71.5  
 250 V 1 A 1 NC

**Ordering data**

Screw connection

Type	Qty.	Order No.
VPU III R 48V/4KV AC/DC	1	135160000

Type	Qty.	Order No.
VPU III R 24V/4KV AC/DC	1	135158000

**Note**

**Accessories**

**Note**



**Type III with varistors / gas discharge tube**

- Type III surge protection
- Suitable for protecting terminals
- Installed in the vicinity of the equipment to be protected
- For mounting on TS35 rail
- Arrester with remote signalling contact
- Tested in accordance with IEC 61643-11

**VPU III R 12 V / 4 kV**

For use as device protector

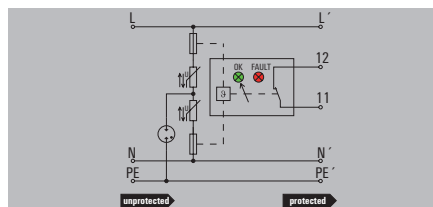

**VPU III SO LD / +A**

For use as device protector

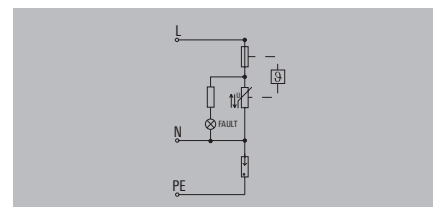
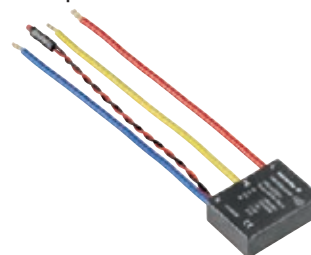

**Technical data**

Rated voltage (AC)	12 V
Rated voltage (DC)	14 V
Max. continuous voltage, U <sub>c</sub> (AC)	20 V
Max. continuous voltage, U <sub>c</sub> (DC)	24 V
Requirements category acc. to IEC 61643-11	Type III
Combined pulse U <sub>oc</sub>	2 kV
Rated discharge current (8/20 μs) I <sub>w</sub>	1.5 kA
Short-circuit resistance I <sub>scCR</sub>	2 kA
Discharge current, max. (8/20 μs)	16 A
Rated load current I <sub>L</sub>	0 μA
PE conductor current I <sub>PE</sub>	< 100 ns
Sparkover time / Drop-out time	16 A
Fusing	≤ 0.98 kV
Protection level U <sub>p</sub> (typical)	22 V
Temporary surge voltage (over-voltage) - TOV	Green LED = OK, LED red = arrester faulty, replace
Optical function display	Installation housing; 1TE, Insta IP 20
Design	-40 °C...+70 °C
Ambient temperature (operational)	-40°C ... +80°C
Storage temperature	
<b>Connection according to IEC 947-7-1</b>	
Solid	0.5...2.5 mm <sup>2</sup>
Stranded	0.5...2.5 mm <sup>2</sup>
Stripping length	7 mm
Tightening torque	0.4...0.5 Nm
<b>Approvals</b>	
Approvals	IEC61643-11, EN61643-11
Standards	

Rated voltage (AC)	230 V
Rated voltage (DC)	275 V
Max. continuous voltage, U <sub>c</sub> (AC)	Type III
Max. continuous voltage, U <sub>c</sub> (DC)	3 kV
Requirements category acc. to IEC 61643-11	1.5 kA
Combined pulse U <sub>oc</sub>	1.5 kA
Rated discharge current (8/20 μs) I <sub>w</sub>	0 μA
Short-circuit resistance I <sub>scCR</sub>	< 100 ns
Discharge current, max. (8/20 μs)	16 A
Rated load current I <sub>L</sub>	≤ 1.5 kV
PE conductor current I <sub>PE</sub>	440 V
Sparkover time / Drop-out time	Red LED
Fusing	Flush mounting
Protection level U <sub>p</sub> (typical)	-25 °C...+55 °C
Temporary surge voltage (over-voltage) - TOV	-40°C ... +60°C
Optical function display	
Design	
Ambient temperature (operational)	
Storage temperature	
<b>Connection according to IEC 947-7-1</b>	
Solid	
Stranded	
Stripping length	
Tightening torque	
<b>Approvals</b>	
Approvals	IEC61643-11, EN61643-11
Standards	

Rated voltage (AC)	230 V
Rated voltage (DC)	275 V
Max. continuous voltage, U <sub>c</sub> (AC)	Type III
Max. continuous voltage, U <sub>c</sub> (DC)	3 kV
Requirements category acc. to IEC 61643-11	1.5 kA
Combined pulse U <sub>oc</sub>	1.5 kA
Rated discharge current (8/20 μs) I <sub>w</sub>	0 μA
Short-circuit resistance I <sub>scCR</sub>	< 100 ns
Discharge current, max. (8/20 μs)	16 A
Rated load current I <sub>L</sub>	≤ 1.5 kV
PE conductor current I <sub>PE</sub>	440 V
Sparkover time / Drop-out time	Red LED
Fusing	Flush mounting
Protection level U <sub>p</sub> (typical)	-25 °C...+55 °C
Temporary surge voltage (over-voltage) - TOV	-40°C ... +60°C
Optical function display	
Design	
Ambient temperature (operational)	
Storage temperature	
<b>Connection according to IEC 947-7-1</b>	
Solid	
Stranded	
Stripping length	
Tightening torque	
<b>Approvals</b>	
Approvals	IEC61643-11, EN61643-11
Standards	

**Dimensions / Signalling contact info**

Clamping range (nominal / min. / max.)	mm <sup>2</sup>
Height x width x depth	mm
Signalling contact	
<b>Note</b>	

**Screw connection**

2.5 / 0.5 / 2.5
102 / 18 / 71.5
250 V 1 A 1 NC

**Without audible signal**

35 / 12 / 25
No

**with acoustic signal (A)**

35 / 12 / 25
No

**Ordering data**

Screw connection
------------------

Type	Qty.	Order No.
VPU III R 12V/4KV AC/DC	1	1351550000

Type	Qty.	Order No.
VPU III SO LD	1	1351680000
VPU III SO LD+A	1	1351700000

**Note**

**Accessories**

**Note**

**Type III with varistors**

- Type III surge protection
- Suitable for protecting 3-phase terminals
- Installed in the vicinity of the equipment to be protected
- For mounting on rail
- Arrester with remote signalling contact
- Tested in accordance with IEC 61643-11

**VPU III 3 / 280 V**

For use as device protector

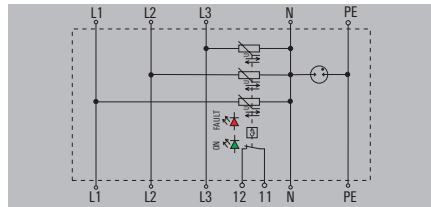

**Technical data**

Rated voltage (AC)	230 V
Max. continuous voltage, U <sub>c</sub> (AC)	275 V
Requirements category acc. to IEC 61643-11	Type III
Combined pulse U <sub>oc</sub>	6 kV
Discharge current, nominal, per path, (8/20 μs)	3 kA
Short-circuit resistance I <sub>scCR</sub>	1.5 kA
Total discharge current I <sub>total</sub>	3 kA
Rated load current I <sub>L</sub>	16 A
PE conductor current I <sub>PE</sub>	0 μA
Sparkover time / Drop-out time	< 100 ns
Fusing	16 A
Protection level U <sub>p</sub> (typical)	≤ 1.8 kV
Optical function display	Green LED = OK, LED red = arrester faulty, replace
Design	Installation housing; 1TE, Insta IP 20
Ambient temperature (operational)	-40 °C...+70 °C
Storage temperature	-40°C ... +80°C
<b>Connection according to IEC 947-7-1</b>	
Solid	0.5...2.5 mm <sup>2</sup>
Stranded	0.5...2.5 mm <sup>2</sup>
Stripping length	7 mm
Tightening torque	0.4...0.5 Nm
<b>Approvals</b>	
Approvals	
Standards	IEC61643-11, EN61643-11

**Dimensions / Signalling contact info**

Clamping range (nominal / min. / max.)	mm <sup>2</sup>	2.5 / 0.5 / 2.5
Height x width x depth	mm	90 / 70 / 57
Signalling contact		250 V 1 A 1 NC
<b>Note</b>		

**Ordering data**

Type	Qty.	Order No.
VPU III 3/280V	1	1393050000

**Note**

**Accessories**

**Note**

C



# Lightning and surge protection for data interfaces

<b>Lightning and surge protection for data interfaces</b>	Surge protection fundamentals for data signals	D.2
	Surge protection for data interfaces	D.4
	Surge protection for telecommunication interfaces	D.26
	Installation instructions for data interfaces	D.28
	Applications for data surge protection / LON™ termination	D.29
	Applications for data surge protection / RS485	D.30
	LON™ application	D.32



# Surge protection for data interfaces

## The principles of data transmission

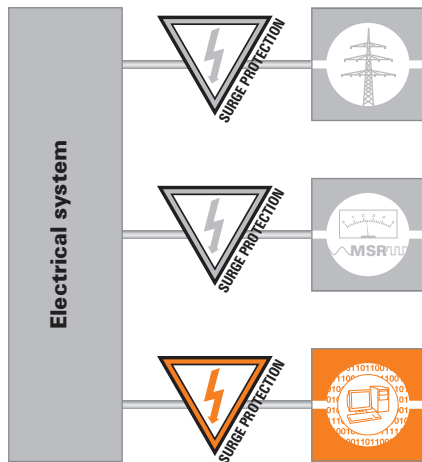

“Data transmission” is the name given to the sending of characters, numbers, statuses and measurements between different, decentralised units. Decentralised units are, for example, controls, computers, measuring sensors, actuators, etc. One unit transmits the data, the second unit receives it. This corresponds to the simplest method of data transmission. It is often necessary for one unit to receive data and then send an “answer” back to the other unit. Two data lines in a back-to-back arrangement are required for this, or data lines are combined by providing each end of the data line with a transmitter and receiver.

### Structures and properties of networks

There are various options for networking data terminals. We distinguish between star, ring, point-to-point and bus networks.

#### Star networks

The main unit is located in the centre. The individual data lines then radiate out from this centre to the individual terminals. In this system all data terminals are connected to the central terminal via their own cable.

#### Ring networks

The computers or data terminals are all connected to each other like a chain by means of, for example, coaxial cable. In this case the data is passed on from one data terminal to the next. Therefore, the entire ring is always under load. The advantage of the ring network is that it can cover a larger area than a star network because the length of the transmission path is only ever the distance between two adjacent data terminals.

#### Point-to-point networks

These are basically networks between two data terminals that are connected directly with each other, e.g. an RS 232 or RS 422 link.

#### Bus networks

These are networks based on the parallel connection of modules. All components operate on one and the same line. Therefore, only two/four wires are required for the data bus. If bus cabling includes branches, then we call that a tree structure. Every bus system includes a bus controller that issues “transmission licences” to the individual data terminals.

#### Transmission media

In order to be able to send any data at all, data lines are necessary:

#### Two- and three-wire systems

Data transmissions requiring relatively low transmission rates can make use of two-wire systems. For example, an ISDN system acting as an exchange line to a building requires only two wires.

However, there are bus systems which also require only two or three wires.

#### Four-wire systems

This is the current standard for the majority of corporate data networks. Two wires are used for transmitting data and two for receiving. These cables are well shielded and can transmit data with frequencies of up to 500 MHz over distances of up to 100 m.

#### Coaxial cable

Sending data via coaxial cables is a rather old technique. This method is too slow and inflexible and only a few businesses are still using such systems. Speeds of up to 12 Mbps are no longer adequate these days. Over longer distances, modern fibre-optic cables have been replacing this technology; these can transmit several hundred Mbps.

#### Serial interfaces

A serial interface operates with 8 data bits (1 byte). A start bit (low bit) is always sent before the output of a byte, and one or two stop bits (high bits) are appended to the end of the byte. This encryption is critical for the data receiver as it can then detect where each data byte begins and ends. Serial interfaces frequently operate with +5 V (logical 1) and 0 V (logical 0). Advantage: less cabling (only 3 wires). Disadvantage: slow data transmission.

**RS 232**

Serial interface for point-to-point connections up to 20 kbit/s  
Voltage signal to earth:  
logic 1 (mark) -15 V to -3 V  
logic 0 (space) +3 V to +15 V  
max. signal level  $\pm 15$  V  
Lines up to 20 m long depending on transmission rate.

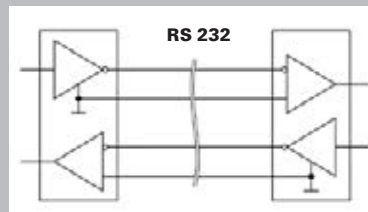

Protection module in terminal housing  
VSSC 6 / RS232

**Page D.14****RS 422**

Serial uni-directional high-speed interface for up to 10 parallel receivers  
Differential voltage signal:  
logic 1 (mark) A-B < -0.3 V  
logic 0 (space) A-B > +0.3 V  
max. signal level  $\pm 12$  V  
Lines up to 1200 m long  
max. data rate 10 Mbit/s

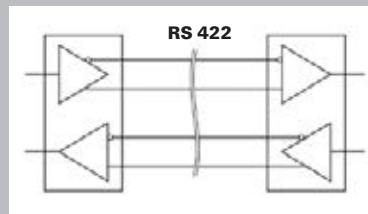

Protection module in plug-in housing  
VSPC / RS485

**Page D.8**

Protective module in housing for fitting to mounting rail  
RS485 K21 / RS422

**Page D.16****RS485**

Serial bi-directional high-speed interface for up to 32 subscribers  
2- or 4-wire system  
Differential voltage signal:  
logic 1 (mark) A-B < -0.3 V  
logic 0 (space) A-B > +0.3 V  
max. signal level -7 V to +12 V  
Lines up to 1200 m long  
max. data rate 10 Mbit/s

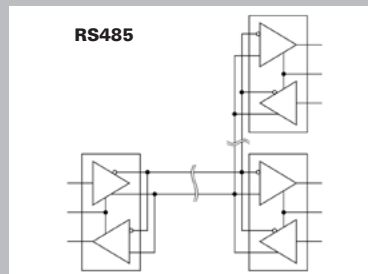

Protection module in plug-in housing  
VSPC / RS485 R

**Page D.10**

Protection module in terminal housing  
VSSC 6 / RS485  
VSSC 6 / RS485 DP

**Page D.14****LON™ (twisted pair)**

Series bus with TP/XF-78 (old)  
Series bus with TP/XF-1250  
Series bus or free topology with TP/FT-10  
Series bus or free topology with LPT-10

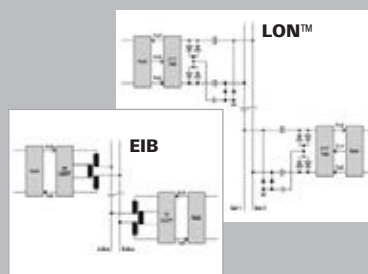

Protective module in housing for fitting to mounting rail  
MCZ ovP LON™-Bus

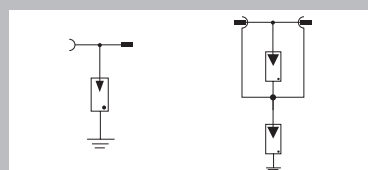
**Page D.17****COAX**

Protective module for BNC- and N-cables

**Page D.22**

Protective module for F- and UHF-cables

**Page D.23**

**VSPC 2CL HF - protection for two analogue high-frequency signals**

- Optional monitoring function with status indicator and alert function
- Pluggable arrester (impedance-neutral plugging/unplugging without interruption)
- Can be tested with the V-TEST testing device
- Version with floating-earth PE connection for avoiding voltage potential differences
- Space-saving design for 2 analogue signals with optional alert function
- Usable in accordance with installation standard IEC 62305
- Tested in accordance with IEC 61643-21:08 D1, C1, C2, C3
- Integrated PE foot, safely discharges up to 20 kA (8/20 µs) and 2.5 kA (10/350 µs) to PE



**Technical data**

Dielectric strength at FG against PE	≥ 500 V
Volume resistance	2.20
Overload - failure mode	Modus 2
Requirements category acc. to IEC 61643-21	C1, C2, C3, D1
Surge current-carrying capacity C1	< 1 kA 8/20 µs
Surge current-carrying capacity C2	5 kA 8/20 µs
Surge current-carrying capacity C3	100 A 10/1000 µs
Surge current-carrying capacity D1	2.5 kA 10/350 µs
Discharge current I <sub>1</sub> (8/20 µs) wire-wire/wire-PE/GND-PE	2.5 kA / 2.5 kA / 2.5 kA
Discharge I <sub>max</sub> (8/20 µs) wire-wire/wire-PE/GND-PE	10 kA / 2 x 10 kA / 10 kA
Lightning test I <sub>imp</sub> (10/350 µs) wire-wire/wire-PE/GND-PE	2.5 kA / 2.5 kA / 2.5 kA
Type of connection	Pluggable in VSPC BASE
Storage temperature	-40 °C...+80 °C
Ambient temperature (operational)	-40 °C...+70 °C
Protection degree	IP 20
<b>Failure probability</b>	
Ages	45
MTTF	2537
SIL in compliance with IEC 61508	3
<b>Approvals</b>	
Approvals	CE; GOSTME25; OEVE; TUEV; UL
Standards	IEC 61643-21

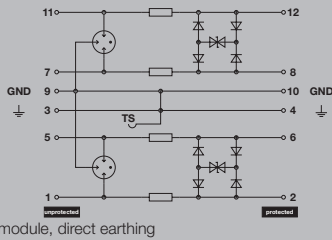

Complete module, direct earthing

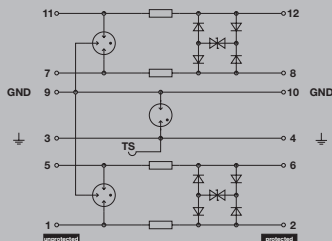

Complete module, indirect earthing

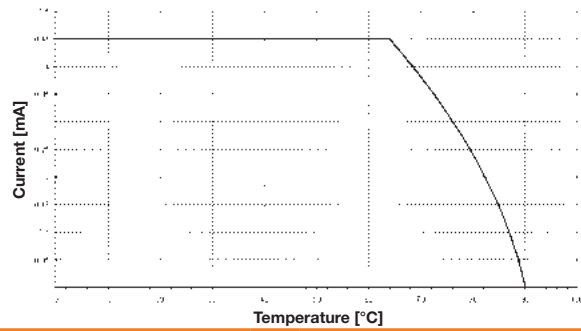

<b>Dimensions of complete module (arrester + base element)</b>	<b>no remote sig. contact</b>
Height x width x depth	mm 90 / 17.8 / 69
<b>Note</b>	The associated VSPC base element should be ordered with this. The dimension information provided refers to the complete module.

**Base elements / base to arresters**



**Ordering data for base**

Description	Type	Qty.	Order No.
Base element, direct earthing	VSPC BASE 2CL	1	8924710000
Base element, indirect earthing / floating earth FG	VSPC BASE 2CL FG	1	8924270000

**Note** Technical data can be found at the end of the VARITECTOR SPC section.

VSPC 2CL HF - arrester / plug-in components



Ordering data

	VSPC 2CL HF 5 V DC	VSPC 2CL HF 12 V DC	VSPC 2CL HF 24 V DC
Rated voltage (AC)			
Rated voltage (DC)	5 V	12 V	24 V
Max. continuous voltage, U <sub>c</sub> (AC)			
Max. continuous voltage, U <sub>c</sub> (DC)	6.4 V	15 V	28 V
Rated current	450 mA	450 mA	450 mA
Input attenuation	103 MHz	104 MHz	109 MHz
Pulse-reset capacity	≤ 20 ms	80 ms	≤ 40 ms
Residual voltage, U <sub>r</sub> , typical	800 V	800 V	800 V
<b>Protection level</b>			
Wire-wire 1 kV/μs, typically	12 V	25 V	45 V
Wire-wire 8/20 μs, typically	12 V	25 V	45 V
Wire-PE 1kV/μs, typically	450 V	450 V	450 V
Wire-PE 8/20 μs, typically	800 V	800 V	800 V

Ordering data	VSPC 2CL HF 5VDC	VSPC 2CL HF 12VDC	VSPC 2CL HF 24VDC
No function display			
Type	VSPC 2CL HF 5VDC	VSPC 2CL HF 12VDC	VSPC 2CL HF 24VDC
Order No.	<b>8924430000</b>	<b>8924460000</b>	<b>8924510000</b>
Qty.	1 ST	1 ST	1 ST
<b>Note</b>			



**VSPC 2CL HF - protection for two analogue high-frequency signals with remote alert**

- Optional monitoring function with status indicator and alert function
- Pluggable arrester (impedance-neutral plugging/unplugging without interruption)
- Can be tested with the V-TEST testing device
- Version with floating-earth PE connection for avoiding voltage potential differences
- Space-saving design for 2 analogue signals with optional alert function
- Usable in accordance with installation standard IEC 62305
- Tested in accordance with IEC 61643-21:08 D1, C1, C2, C3
- Integrated PE foot, safely discharges up to 20 kA (8/20 µs) and 2.5 kA (10/350 µs) to PE



**Technical data**

Dielectric strength at FG against PE	500 V
Volume resistance	2.20
Overload - failure mode	Modus 2
Requirements category acc. to IEC 61643-21	C1, C2, C3, D1
Surge current-carrying capacity C1	< 1 kA 8/20 µs
Surge current-carrying capacity C2	5 kA 8/20 µs
Surge current-carrying capacity C3	100 A 10/1000 µs
Surge current-carrying capacity D1	2.5 kA 10/350 µs
Discharge current $I_n$ (8/20 µs) wire-wire/wire-PE/GND-PE	2.5 kA / 2.5 kA / 2.5 kA
Discharge $I_{max}$ (8/20 µs) wire-wire/wire-PE/GND-PE	10 kA / 2 x 10 kA / 10 kA
Lightning test $I_{imp}$ (10/350 µs) wire-wire/wire-PE/GND-PE	2.5 kA / 2.5 kA / 2.5 kA
Type of connection	Pluggable in VSPC BASE
Storage temperature	-40 °C...+80 °C
Ambient temperature (operational)	-40 °C...+70 °C
Protection degree	IP 20
<b>Failure probability</b>	
Ages	45
MTTF	2537
SIL in compliance with IEC 61508	3
<b>Approvals</b>	
Approvals	CE, GOSTME25, OEVE, TUEV, UL
Standards	IEC 61643-21

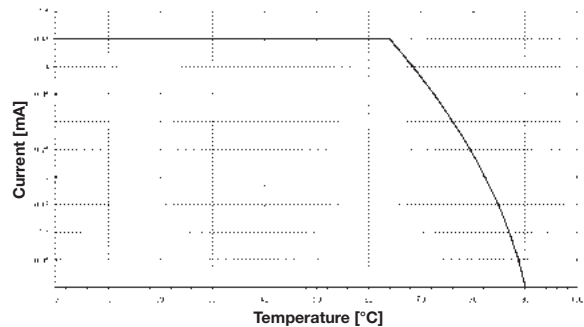
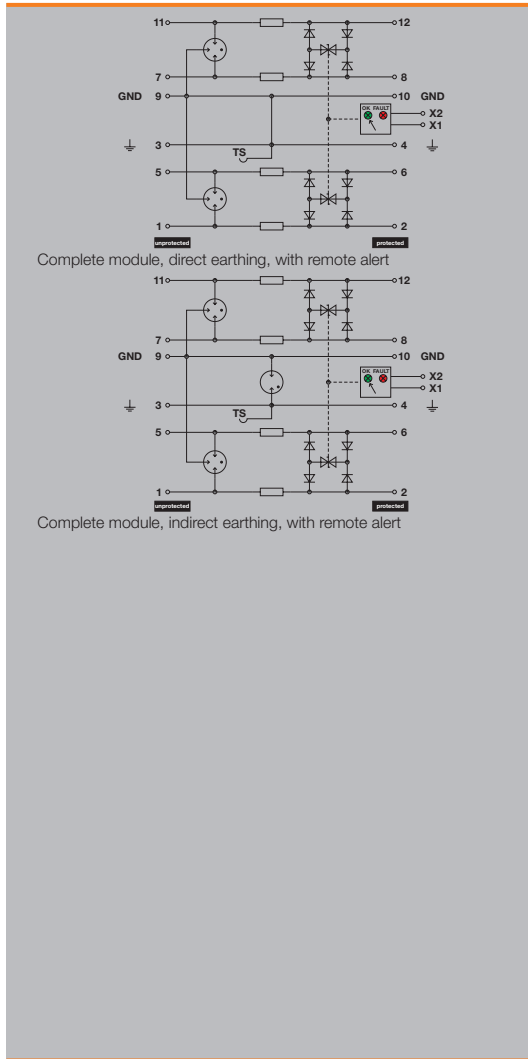

<b>Dimensions of complete module (arrester + base element)</b>	<b>with remote signalling (R)</b>
Height x width x depth	mm 98 / 17.8 / 69
<b>Note</b>	The associated VSPC base element should be ordered with this. The dimension information provided refers to the complete module.

**Base elements / base to arresters**



**Ordering data for base**

Description	Type	Qty.	Order No.
Base element, indirect earthing with remote contact	VSPC BASE 2CL FG R	1	8951720000
Base element, direct earthing with remote contact	VSPC BASE 2CL R	1	8951710000

**Note** Technical data can be found at the end of the VARITECTOR SPC section. Order with VSPC CONTROL UNIT.



**VSPC 2CL HF - arrester / plug-in components  
with remote alert**



Ordering data	VSPC 2CL HF 5 V DC R	VSPC 2CL HF 12 V DC R	VSPC 2CL HF 24 V DC R
Rated voltage (AC)			
Rated voltage (DC)	5 V	12 V	24 V
Max. continuous voltage, U <sub>c</sub> (AC)			
Max. continuous voltage, U <sub>c</sub> (DC)	6.4 V	15 V	28 V
Rated current	450 mA	450 mA	450 mA
Signalling contact	U <sub>N</sub> 250 V AC 0.1 A 1CO at VSPC R with VSPC CONTROL UNIT	U <sub>N</sub> 250 V AC 0.1 A 1CO at VSPC R with VSPC CONTROL UNIT	U <sub>N</sub> 250 V AC 0.1 A 1CO at VSPC R with VSPC CONTROL UNIT
Optical function display	green = OK; red = arrester is defective - replace	green = OK; red = arrester is defective - replace	green = OK; red = arrester is defective - replace
Input attenuation	103 MHz	104 MHz	109 MHz
Pulse-reset capacity	≤ 20 ms	≤ 80 ms	≤ 40 ms
Residual voltage, U <sub>r</sub> , typical	800 V	800 V	800 V
<b>Protection level</b>			
Wire-wire 1 kV/μs, typically	12 V	25 V	45 V
Wire-wire 8/20 μs, typically	12 V	25 V	45 V
Wire-PE 1kV/μs, typically	450 V	450 V	450 V
Wire-PE 8/20 μs, typically	800 V	800 V	800 V
<b>Ordering data</b>			
With functional display	Type	Type	Type
	VSPC 2CL HF 5VDC R	VSPC 2CL HF 12VDC R	VSPC 2CL HF 24VDC R
	<b>Order No. 8951680000</b>	<b>Order No. 8951690000</b>	<b>Order No. 8951700000</b>
	Qty. 1 ST	Qty. 1 ST	Qty. 1 ST
<b>Note</b>			



VSPC RS485

- Pluggable arrester (impedance-neutral plugging/unplugging without interruption)
- Can be tested with the V-TEST testing device
- Optional monitoring function with status indicator and alert functions
- Lower residual voltage
- Version with floating-earth PE connection for avoiding voltage potential differences
- Tested in accordance with IEC 61643-21:08
- Integrated PE foot, safely discharges up to 20 kA (8/20  $\mu$ s) and 2.5 kA (10/350  $\mu$ s) to PE



Technical data

Dielectric strength at FG against PE	$\geq 500$ V
Volume resistance	2.20 $\Omega$
Overload - failure mode	Modus 2
Requirements category acc. to IEC 61643-21	C1, C2, C3, D1
Surge current-carrying capacity C1	< 1 kA 8/20 $\mu$ s
Surge current-carrying capacity C2	5 kA 8/20 $\mu$ s
Surge current-carrying capacity C3	100 A 10/1000 $\mu$ s
Surge current-carrying capacity D1	2.5 kA 10/350 $\mu$ s
Discharge current $I_t$ (8/20 $\mu$ s) wire-wire/wire-PE/GND-PE	2.5 kA / 2.5 kA / 2.5 kA
Discharge $I_{max}$ (8/20 $\mu$ s) wire-wire/wire-PE/GND-PE	10 kA / 2 x 10 kA / 10 kA
Lightning test $I_{imp}$ (10/350 $\mu$ s) wire-wire/wire-PE/GND-PE	0.2 kA / 2 x 0.2 kA / 0.2 kA
Type of connection	Pluggable in VSPC BASE
Storage temperature	-40 °C...+80 °C
Ambient temperature (operational)	-40 °C...+70 °C
Protection degree	IP 20
<b>Failure probability</b>	
Ages	57
MTTF	2003
SIL in compliance with IEC 61508	3
<b>Approvals</b>	
Approvals	CE; GOSTME25; OEVE; TUEV; UL
Standards	IEC 61643-21

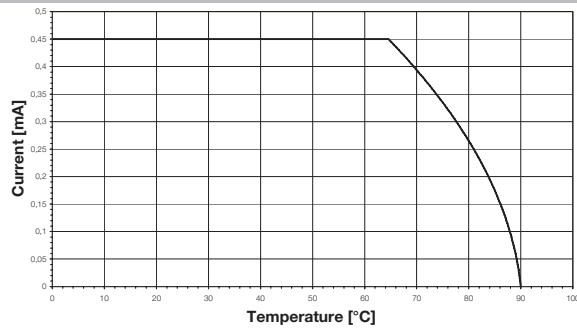

<b>Dimensions of complete module (arrester + base element)</b>	<b>no remote sig. contact</b>
Height x width x depth	mm 90 / 17.8 / 69
<b>Note</b>	The associated VSPC base element should be ordered with this. The dimension information provided refers to the complete module.

Base elements / base to arresters



Ordering data for base

Description	Type	Qty.	Order No.
Base element, direct earthing	VSPC BASE 2CL	1	8924710000
Base element, indirect earthing / floating earth FG	VSPC BASE 2CL FG	1	8924270000

**Note** Technical data can be found at the end of the VARITECTOR SPC section.

## VSPC RS485 - arrester / plug-in components



## Ordering data

Rated voltage (AC)  
 Rated voltage (DC)  
 Max. continuous voltage,  $U_c$  (AC)  
 Max. continuous voltage,  $U_c$  (DC)  
 Rated current  
 Input attenuation  
 Pulse-reset capacity  
 Residual voltage,  $U_r$ , typical

## VSPC RS485 2CH

5 V  
 6.4 V  
 450 mA  
 113.6 MHz  
 $\leq 20$  ms  
 35 V

## Protection level

Wire-wire 1 kV/ $\mu$ s, typically  
 Wire-wire 8/20  $\mu$ s, typically  
 Wire-PE 1kV/ $\mu$ s, typically  
 Wire-PE 8/20  $\mu$ s, typically

10 V  
 15 V  
 10 V  
 35 V

## Ordering data

No function display      Type  
    Order No.  
    Qty.

VSPC RS485 2CH  
**8924670000**  
 1 ST

## Note



VSPC RS485 with remote alert

- Pluggable arrester (impedance-neutral plugging/unplugging without interruption)
- Can be tested with the V-TEST testing device
- Optional monitoring function with status indicator and alert functions
- Lower residual voltage
- Version with floating-earth PE connection for avoiding voltage potential differences
- Tested in accordance with IEC 61643-21:08
- Integrated PE foot, safely discharges up to 20 kA (8/20 μs) and 2.5 kA (10/350 μs) to PE



Technical data

Dielectric strength at FG against PE	≥ 500 V
Volume resistance	2.20 Ω
Overload - failure mode	Modus 2
Requirements category acc. to IEC 61643-21	C1, C2, C3, D1
Surge current-carrying capacity C1	< 1 kA 8/20 μs
Surge current-carrying capacity C2	5 kA 8/20 μs
Surge current-carrying capacity C3	100 A 10/1000 μs
Surge current-carrying capacity D1	2.5 kA 10/350 μs
Discharge current I <sub>d</sub> (8/20 μs) wire-wire/wire-PE/GND-PE	2.5 kA / 2.5 kA / 2.5 kA
Discharge I <sub>max</sub> (8/20 μs) wire-wire/wire-PE/GND-PE	10 kA / 2 x 10 kA / 10 kA
Lightning test I <sub>imp</sub> (10/350 μs) wire-wire/wire-PE/GND-PE	0.2 kA / 2 x 0.2 kA / 0.2 kA
Type of connection	Pluggable in VSPC BASE
Storage temperature	-40 °C...+80 °C
Ambient temperature (operational)	-40 °C...+70 °C
Protection degree	IP 20
<b>Failure probability</b>	
Ages	90
MTTF	1266
SIL in compliance with IEC 61508	3
<b>Approvals</b>	
Approvals	CE, GOSTME25, OEVE, TUEV, UL
Standards	IEC 61643-21

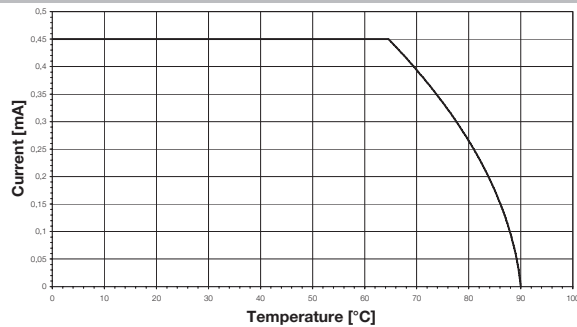
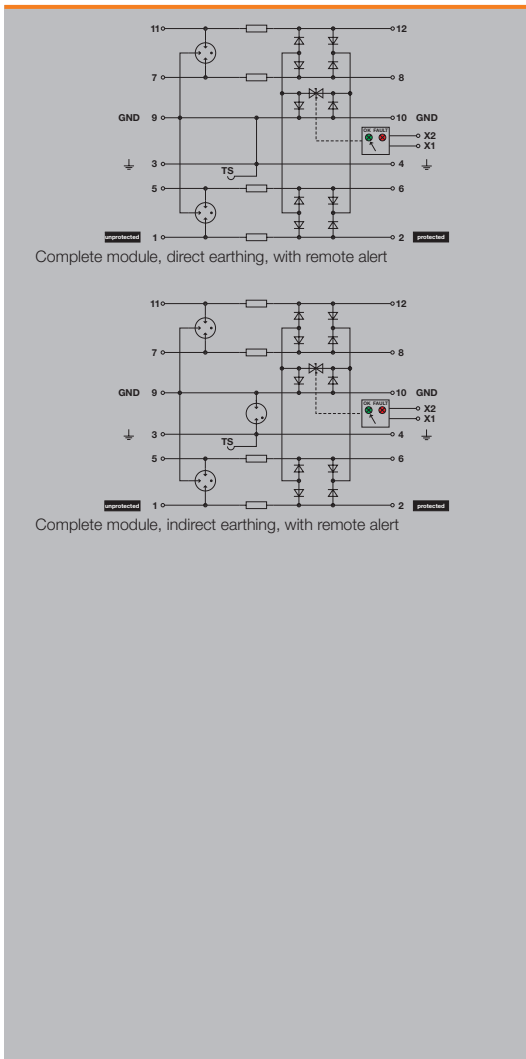

<b>Dimensions of complete module (arrester + base element)</b>	<b>with remote signalling (R)</b>
Height x width x depth	mm 98 / 17.8 / 69
<b>Note</b>	The associated VSPC base element should be ordered with this. The dimension information provided refers to the complete module.

Base elements / base to arresters



Ordering data for base

Description	Type	Qty.	Order No.
Base element, indirect earthing with remote contact	VSPC BASE 2/4CH FG R	1	8951800000
Base element, direct earthing with remote contact	VSPC BASE 2/4CH R	1	8951790000

**Note** Technical data can be found at the end of the VARITECTOR SPC section. Order with VSPC CONTROL UNIT.

## VSPC RS485 - arrester / plug-in components with remote alert



### Ordering data

Ordering data		VSPC RS485 2CH R
Rated voltage (AC)		
Rated voltage (DC)		5 V
Max. continuous voltage, $U_c$ (AC)		
Max. continuous voltage, $U_c$ (DC)		6.4 V
Rated current		450 mA
Signalling contact		$U_N$ 250 V AC 0.1 A 1CO at VSPC R with VSPC CONTROL UNIT
Optical function display		green = OK; red = arrester is defective - replace
Input attenuation		113.6 MHz
Pulse-reset capacity		$\leq 20$ ms
Residual voltage, $U_r$ , typical		35 V
Protection level		
Wire-wire 1 kV/ $\mu$ s, typically		10 V
Wire-wire 8/20 $\mu$ s, typically		15 V
Wire-PE 1 kV/ $\mu$ s, typically		10 V
Wire-PE 8/20 $\mu$ s, typically		35 V

Ordering data		
With functional display	Type	VSPC RS485 2CH R
	Order No.	<b>8951670000</b>
	Qty.	1 ST
Note		



### V DATA Cat.6 - surge protection for 8 wires with RJ45 socket

- RJ45 connection
- All 4 lines are protected
- Robust and compact metal housing
- Suitable for Cat.5 (to 100 MHz) and Cat.6 to 250 Mhz (class E)
- Suitable for PoE (IEEE 802.3af) and PoE + (IEEE 802.3at)

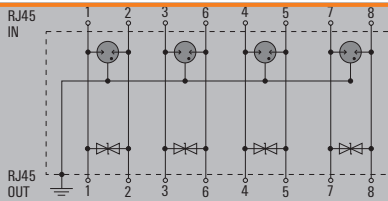

### Technical data

Requirements category acc. to IEC 61643-21	C2, D1
Surge current-carrying capacity C1	
Surge current-carrying capacity C2	5 kA
Surge current-carrying capacity C3	
Surge current-carrying capacity D1	1 kA
Discharge current $I_t$ (8/20 $\mu$ s) wire-wire/wire-PE/GND-PE	5 kA / 5 kA / 5 kA
Discharge $I_{max}$ (8/20 $\mu$ s) wire-wire/wire-PE/GND-PE	10 kA / 5 kA
Lightning test $I_{imp}$ (10/350 $\mu$ s) wire-wire/wire-PE/GND-PE	1 kA / 1 kA / 1 kA
Type of connection	RJ45-Port
Storage temperature	-40 ... +85 °C
Ambient temperature (operational)	-40 °C...+80 °C
Protection degree	IP 20
<b>Approvals</b>	
Approvals	
Standards	According to IEC61643-21

### Dimensions of complete module (arrester + base element)

Height x width x depth	mm	75 / 19 / 46
------------------------	----	--------------

<b>Note</b>	Can also be used for Cat.5 applications
-------------	---

V DATA Cat.6 - surge protection for 8 wires with RJ45 socket

Ordering data

V DATA CAT6	
Rated voltage (AC)	60 V
Rated voltage (DC)	
Max. continuous voltage, U <sub>c</sub> (AC)	
Max. continuous voltage, U <sub>c</sub> (DC)	
Rated current	1 A
Input attenuation	250 kHz
Pulse-reset capacity	
Residual voltage, U <sub>r</sub> , typical	550 V

Ordering data	
Type	VDATA CAT6
Order No.	<b>1348590000</b>
Qty.	1 ST
Note	



**VSSC 6AN RS485, RS485 DP and RS232 –  
for interface signals**

- Two-stage surge protection with screw connection for RS422/RS485 data interfaces
- Surge protection in terminal block design
- Modular width of only 6.2 mm
- Space-saving design: 1 signal
- Torx® slotted screw connection
- Can be used in compliance with installation standard IEC 62305
- Tested in accordance with IEC 61643-21: D1, C2, C3
- Integrated PE foot, safely discharges up to 20 kA (8/20 μs) and 2.5 kA (10/350 μs) to PE



Similar to illustration



Similar to illustration

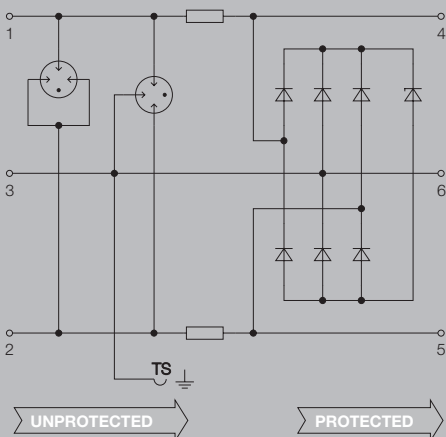
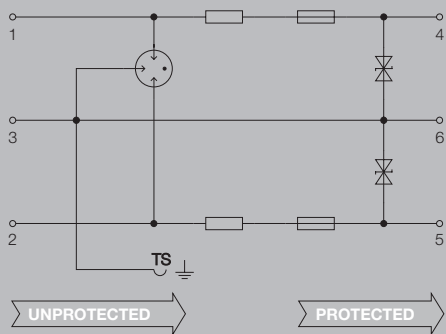

**Technical data**

Rated current	500 mA
Volume resistance	1.8 Ω 10 %
Overload - failure mode	Modus 2
Requirements category acc. to IEC 61643-21	C2, C3, D1
Standards	IEC 61643-21
Surge current-carrying capacity C1	
Surge current-carrying capacity C2	2.5 kA 8/20 μs 5 kV 1.2/50 μs
Surge current-carrying capacity C3	10 A 10/1000 μs
Surge current-carrying capacity D1	0.5 kA 10/350 μs
Discharge current I <sub>1</sub> (8/20 μs) wire-wire/wire-PE/GND-PE	2.5 kA / 2.5 kA /
Discharge I <sub>max</sub> (8/20 μs) wire-wire/wire-PE/GND-PE	10 kA / 10 kA /
Lightning test I <sub>imp</sub> (10/350 μs) wire-wire/wire-PE/GND-PE	/ 0.5 kA /
Storage temperature	-40 °C...+80 °C
Ambient temperature (operational)	-40 °C...+70 °C
Protection degree	IP 20
UL 94 flammability rating	V-0
<b>Connection data</b>	
Type of connection	Screw connection, Torx® T15, Slotted 0.8 x 4
Tightening torque	0.5 Nm
Wire connection cross section, finely stranded, max.	4 mm <sup>2</sup>
Wire connection cross-section, finely stranded, min.	0.5 mm <sup>2</sup>
Wire cross-section, solid, max.	6 mm <sup>2</sup>
Wire cross-section, solid, min.	0.5 mm <sup>2</sup>
Wire cross-section, stranded, max.	4 mm <sup>2</sup>
Wire cross-section, stranded, min.	0.5 mm <sup>2</sup>
Stripping length	10 mm
Mounting rail	TS 35
<b>Failure probability</b>	
Ages	60
MTTF	1903
SIL in compliance with IEC 61508	3
<b>Approvals</b>	
Approvals	CE; GOSTME25; OEVE; TUEV; UL; ROHS
Standards	IEC 61643-21

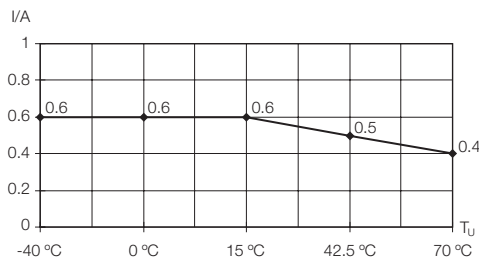

**Dimensions**

Height x width x depth mm 88.5 / 6.1 / 81

**Note**

## VSSC 6AN RS485, RS485 DP and RS232

Ordering data		RS485	RS485 DP	RS232
Rated voltage (AC)				
Rated voltage (DC)		12 V	12 V	12 V
Max. continuous voltage, U <sub>c</sub> (AC)				
Max. continuous voltage, U <sub>c</sub> (DC)		15 V	15 V	15 V
Rated current		500 mA	500 mA	500 mA
Signalling contact		No	No	No
Input attenuation		113.6 MHz	113.6 MHz	1.4 MHz
Pulse-reset capacity		≤ 15 ms	≤ 15 ms	≤ 15 ms
Residual voltage, U <sub>r</sub> typical		94 V	94 V	80 V
Protection level				
Wire-wire 1 kV/μs, typically				
Wire-wire 8/20 μs, typically				
Wire-PE 1kV/μs, typically		94 V	94 V	80 V
Wire-PE 8/20 μs, typically				
Ordering data				
Type	VSSC6 RS485	VSSC6 RS485 DP	VSSC6 RS232	
Order No.	<b>1064980000</b>	<b>1065010000</b>	<b>1064990000</b>	
Qty.	10 ST	10 ST	10 ST	
Note	End plate AP VSSC6 1063110000	End plate AP VSSC6 1063110000	End plate AP VSSC6 1063110000	

D



RS485/422

RS485

RS485/RS422 surge protection

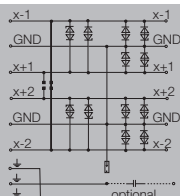

Technical data

Rated voltage (AC)  
 Max. continuous voltage, U<sub>c</sub> (AC)  
 Operating current, I<sub>max</sub>  
 Volume resistance  
 Baud rate  
 Sparkover time / Drop-out time  
 Gas discharge tube  
 Suppression diodes  
 Limiting frequency (-3 dB) at load resistance  
 Discharge current, max. (8/20 μs)  
 Design  
 Type of connection  
 Ambient temperature (operational)  
 Storage temperature

12 V  
 12 V  
 1.5 A  
 0.50 Ω  
 ≤ 6 MB  
 ≤ 5 ns  
 Yes  
 Yes  
 0.5 kA  
 Miscellaneous  
 Screw connection  
 -25 °C...+60 °C  
 -25 °C...+85 °C

Protection level

Wire-wire 1 kV/μs, typically  
 Wire-wire 8/20 μs, typically  
 Wire-PE 1kV/μs, typically  
 Wire-PE 8/20 μs, typically

18 V  
 28 V  
 18 V  
 28 V

Approvals

Approvals  
 Standards

CE: GOSTME25

Dimensions

Clamping range (nominal / min. / max.) mm<sup>2</sup>  
 Height x width

Screw connection

1.5 / 0.5 / 4  
 125 / 80

Note

Ordering data

Type	Qty.	Order No.
RS 485 K21 UE-SCHUTZ SE	1	8008501001

Note

Accessories

Note



**LON™**

- 6.2 mm wide surge protection with tension-clamp connection
- Fast wiring due to the TS contacts

**LON™ FTT / TP78**

Protection for LonWorks™ signals

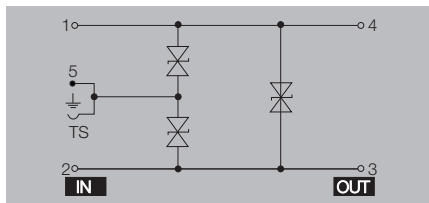

**Technical data**

Rated voltage (AC)  
 Max. continuous voltage, U<sub>c</sub> (AC)  
 Operating current, I<sub>max</sub>  
 Volume resistance  
 Sparkover time / Drop-out time  
 Gas discharge tube  
 Suppression diodes  
 Discharge current, max. (8/20 μs)  
 Design  
 Type of connection  
 Ambient temperature (operational)  
 Storage temperature

12 V  
 14 V  
 16 A  
 0.50 Ω  
 ≤ 100 ps  
 No  
 Yes  
 0.1 kA  
 Terminal  
 Tension clamp connection  
 -25 °C...+55 °C  
 -25 °C...+60 °C

**Protection level**

Wire-wire 1 kV/μs, typically  
 Wire-wire 8/20 μs, typically  
 Wire-PE 1kV/μs, typically  
 Wire-PE 8/20 μs, typically

20 V  
 32 V  
 20 V  
 32 V

**Approvals**

Approvals  
 Standards

CE; GOSTME25

**Dimensions**

Clamping range (nominal / min. / max.) mm<sup>2</sup>  
 Height x width x depth mm

**Tension-clamp connection**

1.5 / 0.5 / 1.5  
 91 / 6 / 63.2

**Note**

**Ordering data**

Type	Qty.	Order No.
MCZ OVP LON-Bus	10	8473470000

**Note**

LON™ is a trademark of Echolon

**Accessories**

**Note**



# The Concept

## The IP 20 Solution

Until now, all signal conditioning tasks were carried out by modules designed to IP 20. For their own protection, these need to be installed in central switchgear cabinets.

However, decentralised solutions that do not require large switchgear cabinets are increasingly being sought for use in modern-day industrial automation technology.

It is true that shielded signals can be fed to the machinery via powerful fieldbus systems; but in each case, however, there remains an interconnecting cable between the subdistribution boards and the sensors/actuators that is susceptible to interference from surrounding operations. As has always been the case, signals are still influenced by overvoltages and earth loops; interference pulses are superimposed on sensor signals and malfunctions can be initiated.

The result is that signal conditioning modules sealed to IP 20 require terminal boxes, such as switchgear cabinets, or even cost-intensive special solutions (for example, sensor-actuator distributors with integrated signal-conditioning functions providing as many functionalities as possible, even when these are surplus to requirements).

## The JACKPAC® solution for IP 67

By introducing **JACKPAC®**, the M12/RJ45 signal box for Ethernet Cat. 6 with a high-protection rating of IP 67, Weidmüller now has a modular, versatile strategy that makes it possible to condition signals in an industrial environment. Requiring no additional enclosure, these modules can be installed directly on the machine, in the production plant, conveyor system or within a process.

The M12 connector, which is standardised all over the world, makes it possible to integrate the **JACKPAC®** at any point in the sensor-actuator cabling. The fixed pin assignment means it is easy to install and is protected against polarity reversal. This versatility really comes into its own when an installation needs to be altered or modernised, simply because no additional enclosures or cabling are required.

By providing this high degree of protection and versatility, **JACKPAC®** renders possible innovative automation concepts based on decentralised applications – without large control cabinets or small distribution boards – for consistent, transparent, efficient and cost-efficient installations.

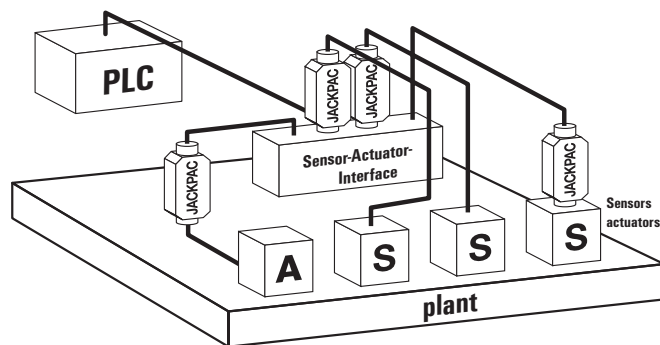

- Easy 'Plug and Play' installation
- Universal and versatile usage
- No additional enclosure required
- Saves time and costs
- Ideal for decentralised concepts and plant modernisation (retrofitting)
- Directly on-site at the facility
- Simple to retrofit if there are malfunctions in the field



## Single-stage surge protection

Surge protection protects equipment against surge voltages that can occur as a result of atmospheric discharges or storms. This type of protection, in the form of an adapter plug, is available in IP20 and IP67 versions and complies with the requirements of C 2 of IEC 61643-21.

## JPOVP Cat.6 IP 20

Ethernet Cat.6

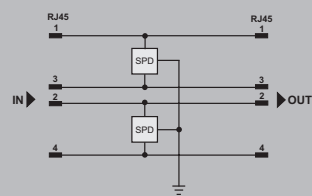

## JPOVP Cat.6 IP 67

Ethernet Cat.6

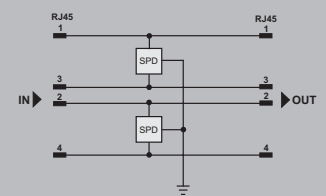

## Technical data

### Technical data

Rated voltage  
Operating voltage  
Discharge current, nominal, per path, (8/20  $\mu$ s)  
Total discharge current, max. (8/20  $\mu$ s)  
DC Response/dropout Volt  
Sparkover time / Drop-out time  
Rated current

### Protection level

Wire-wire 1 kV/ $\mu$ s, typically  
Wire-wire 8/20  $\mu$ s, typically  
Wire-PE 1kV/ $\mu$ s, typically  
Wire-PE 8/20  $\mu$ s, typically

### General data

Ambient temperature (operational)  
Surge voltage category  
Pollution severity  
Type of connection

### Approvals

Approvals  
Standards

34 V / 48 V

48 V

5 kA

10 kA

230 V

$\leq 5$  ns

0.2 A

80 V

300 V

130 V

600 V

-25 °C...+60 °C

III

2

IP20, RJ45 plug

CE

34 V / 48 V

48 V

5 kA

10 kA

230 V

$\leq 5$  ns

0.2 A

80 V

300 V

130 V

600 V

-25 °C...+60 °C

III

2

IP67, RJ45 plug

CE

## Dimensions

Clamping range (nominal / min. / max.) mm<sup>2</sup>

Height x width x depth mm

## Note

53 / 36 / 14.4

Each with 1.5 m cable

53 / 36 / 14.4

Each with 1 m cable and IP67 cable gland

## Ordering data

Type	Qty.	Order No.
JPOVP RJ45 Cat6 IP20	1	8805550000

Type	Qty.	Order No.
JPOVP RJ45 Cat6 IP67	1	8805560000

## Note

## Accessories

### Note

Retaining clip  
JP CLIP M 8778490000

Retaining clip  
JP CLIP M 8778490000

## Surge protection for data interfaces

## Single-stage surge protection

This type of surge protection is plugged into the signal circuits in order to protect sensitive electronics. The interference suppression circuit with varistor suppresses the voltage induced by solenoid valves.

## JPOVP 24 V DC MOV M12

## Suppression circuit with diode

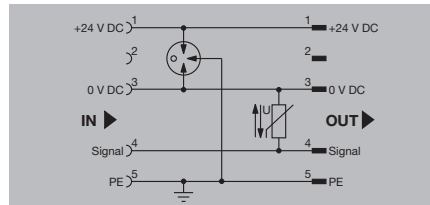

## JPOVP Cat.5 M12

## Ethernet Cat.5

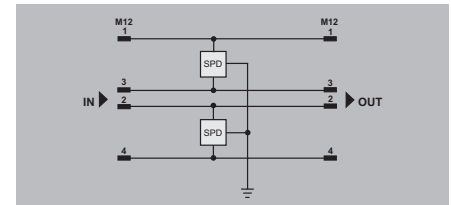

## Technical data

## Technical data

Rated voltage
Operating voltage
Discharge current, nominal, per path, (8/20 μs)
Total discharge current, max. (8/20 μs)
DC Response/dropout Volt
Sparkover time / Drop-out time
Rated current

## Protection level

Wire-wire 1 kV/μs, typically
Wire-wire 8/20 μs, typically
Wire-PE 1 kV/μs, typically
Wire-PE 8/20 μs, typically

## General data

Ambient temperature (operational)
Surge voltage category
Pollution severity
Type of connection

## Approvals

Approvals
Standards

/ 24 V

28 V

5 kA

10 kA

90 V

≤ 25 ns

2 A

85 V

85 V

230 V

-25 °C...+60 °C

II

2

M12 - plug/socket, A-coded

CE

30 V / 30 V

30 V

5 kA

10 kA

230 V

≤ 5 ns

0.2 A

80 V

300 V

130 V

600 V

-25 °C...+60 °C

III

2

M12 - plug/plug, D-coded, Acc. to IEC 61076-2-101-AI

CE

## Dimensions

Clamping range (nominal / min. / max.)	mm <sup>2</sup>
Height x width x depth	mm

## Note

83 / 36 / 14.4

The PE connection should be reliably connected to the earth potential of the system.

57 / 36 / 14.4

The PE connection should be reliably connected to the earth potential of the system.

## Ordering data

Type	Qty.	Order No.
JPOVP 24VDC MOV M12	1	8760960000

Type	Qty.	Order No.
JPOVP M12 D-coded Cat5	1	8805570000

## Note

## Accessories

## Note

Retaining clip  
JP CLIP M 8778490000Retaining clip  
JP CLIP M 8778490000



## Surge protection for data interfaces

### Coax surge protection

Surge protection for COAX data networks

- Metal housings
- Surge protection using gas discharge tube
- Easy handling using socket-adaptor function, with minimal attenuation

### BNC Connector / M-F

Protection for video monitoring systems



### N Connector / M-F

Protection for transmitters, GSM

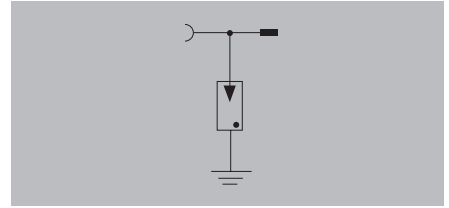
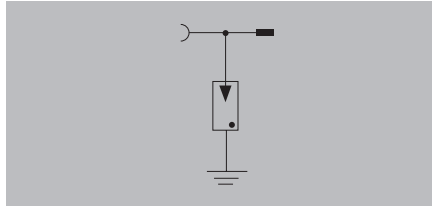

### Technical data

Transmission capacity, max.
Max. continuous voltage, U <sub>c</sub> (DC)
Characteristic impedance
Frequency range
Operating current, I <sub>max</sub>
Insertion loss (attenuation)
Return loss (attenuation)
Standing wave ratio, VSWR
Requirements category acc. to IEC 61643-21
Lightning test current I <sub>imp</sub> (10/350 μs)
Discharge current, max. (8/20 μs)
Sparkover time / Drop-out time
Protection level Up (typical)
Earthing
Type of connection
Version
Ambient temperature (operational)

40 W
90 V ± 20 %
50 Ω
0...25 GHz
5 A
< 0.2 dB
> 20 dB
< 1.2
D1, C3, C2, C1
5 kA
20 kA
≤ 100 ns
< 600 V
Required with M6 screw
Plug / socket
Adapter plug
-40 °C...+80 °C

25 W
90 V ± 20 %
50 Ω
0...25 GHz
5 A
< 0.15 dB
> 20 dB
< 1.2
D1, C3, C2, C1
5 kA
20 kA
≤ 100 ns
< 600 V
Required with M6 screw
Plug / socket
Adapter plug
-40 °C...+80 °C

### Approvals

Approvals  
Standards

### Dimensions

Clamping range (nominal / min. / max.) mm<sup>2</sup>

Height x width

### Note

### Plug / socket

24 / 25

### Plug / socket

73.4 / 25

### Ordering data

Type	Qty.	Order No.
BNC Connector / M-F	1	8947820000

Type	Qty.	Order No.
N Connector / M-F	1	8947830000

### Note

### Accessories

### Note

### Coax surge protection

Surge protection for COAX data networks

- Metal housings
- Surge protection using gas discharge tube
- Easy handling using socket-adaptor function, with minimal attenuation



#### Technical data

Transmission capacity, max.
Max. continuous voltage, U <sub>c</sub> (DC)
Characteristic impedance
Frequency range
Operating current, I <sub>max</sub>
Insertion loss (attenuation)
Return loss (attenuation)
Standing wave ratio, VSWR
Requirements category acc. to IEC 61643-21
Lightning test current I <sub>imp</sub> (10/350 μs)
Discharge current, max. (8/20 μs)
Sparkover time / Drop-out time
Protection level Up (typical)
Earthing
Type of connection
Version
Ambient temperature (operational)

#### Approvals

Approvals  
Standards

#### Dimensions

Clamping range (nominal / min. / max.)	mm <sup>2</sup>
Height x width x depth	

#### Note

#### Ordering data

Type	Qty.	Order No.
F Connector / M-F	1	8947840000

#### Note

#### Accessories

#### Note

### F Connector / M-F

Protection for satellite systems

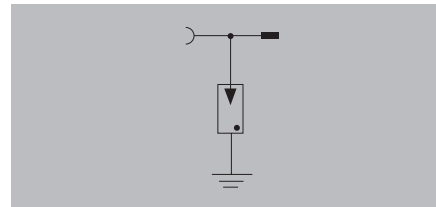

Transmission capacity, max.
Max. continuous voltage, U <sub>c</sub> (DC)
Characteristic impedance
Frequency range
Operating current, I <sub>max</sub>
Insertion loss (attenuation)
Return loss (attenuation)
Standing wave ratio, VSWR
Requirements category acc. to IEC 61643-21
Lightning test current I <sub>imp</sub> (10/350 μs)
Discharge current, max. (8/20 μs)
Sparkover time / Drop-out time
Protection level Up (typical)
Earthing
Type of connection
Version
Ambient temperature (operational)

#### Plug / socket

73.4 / 25

Type	Qty.	Order No.
F Connector / M-F	1	8947840000

#### Note

#### Accessories

#### Note

### UHF Connector / M-F

Protection for terrestrial TV

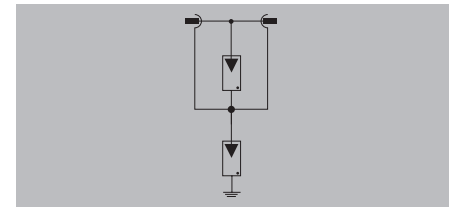

Transmission capacity, max.
Max. continuous voltage, U <sub>c</sub> (DC)
Characteristic impedance
Frequency range
Operating current, I <sub>max</sub>
Insertion loss (attenuation)
Return loss (attenuation)
Standing wave ratio, VSWR
Requirements category acc. to IEC 61643-21
Lightning test current I <sub>imp</sub> (10/350 μs)
Discharge current, max. (8/20 μs)
Sparkover time / Drop-out time
Protection level Up (typical)
Earthing
Type of connection
Version
Ambient temperature (operational)

#### Plug / socket

73.4 / 43 / 24

Type	Qty.	Order No.
UHF Connector / M-F	1	8947850000

#### Note

#### Accessories

#### Note



D



**BNC Connector / M-F**

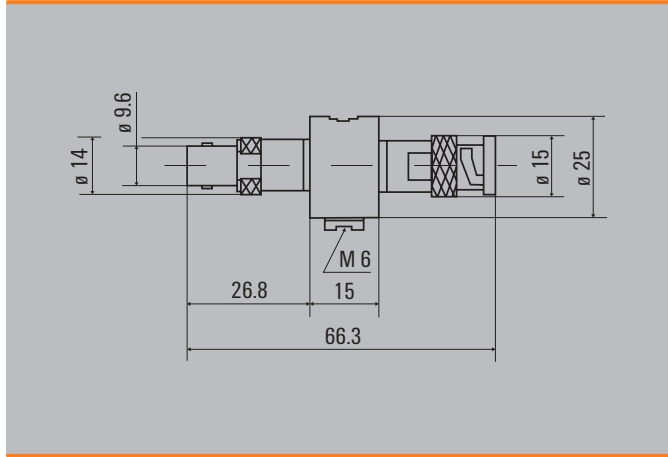

**N Connector / M-F**

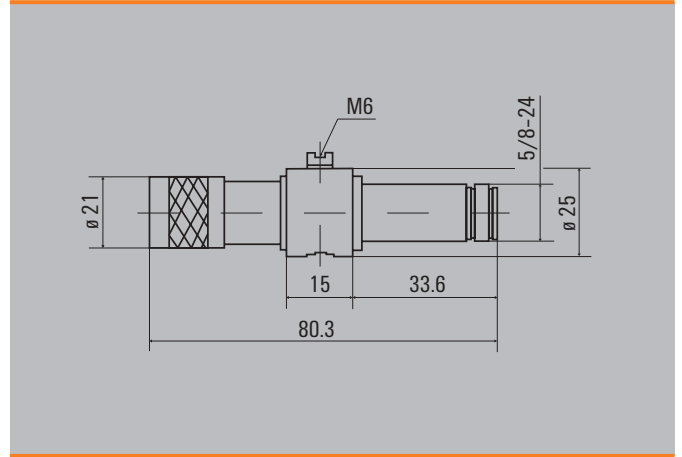

**F Connector / M-F**

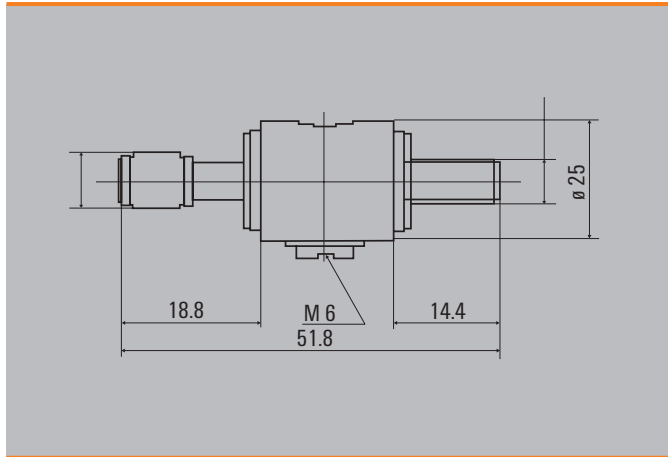

**UHF Connector / M-F**

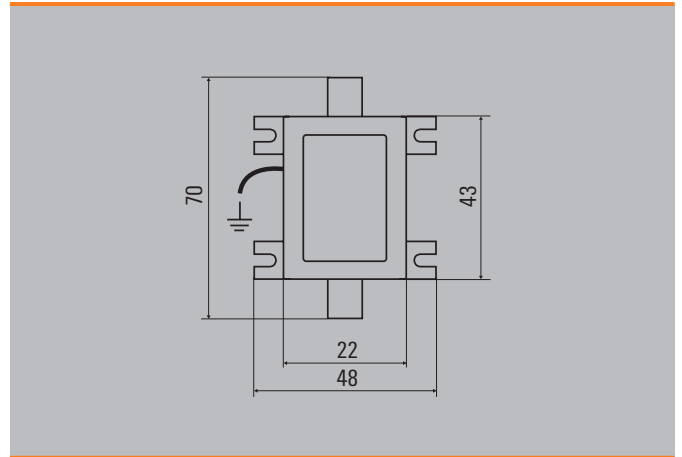



# Surge protection for TAE telecommunication interfaces

## Surge protection for analogue connections

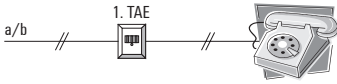

Besides the use of standard telephones, an analogue installation can also be used to transmit data services such as fault signalling systems and the Internet. As well as telephones, fax machines and modems, are also connected to the analogue line, which means that surges due to transient interference phenomena are on the increase.

TAE surge protection for analogue lines is necessary to achieve protection against these surges. The basic version of the surface-mounted TAE-NFN socket has two-stage surge protection provided by a gas discharge tube and fast-acting suppression diodes.

The gas discharge tube achieves a high energy discharge; the suppression diodes ensure a low residual voltage. This setup protects the end terminals. Other TAE surge protection sockets with monitoring functions are also available.

These monitor the connection of the voice voltage/operating voltage. As soon as this is interrupted or short-circuited, the output is switched to high resistance. This signal can be evaluated via a PLC input. A visual indication (green LED) instead of the remote signalling option can be selected as an option.

### Installation instructions

The incoming telephone line must be connected with the right polarity La (-) / Lb (+). The connection of the operating voltage for the  $U_{ko}$  interface is monitored (transistor output is enabled). As soon as this is interrupted or short-circuited, the output is switched to high resistance. The signalling voltage of the TAE ISDN FM can be evaluated via a PLC input.

On the TAE ISDN LED model an LED indicates the operating status.

## Surge protection for ISDN connections Telephone connections at the $U_{ko}/S_0$ interface

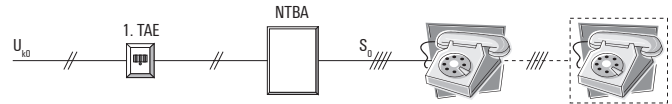

Digital signalling enables more intensive use of larger volumes of data and enables higher demands to be placed on communications.

The desire to communicate via several lines calls for the installation of a digital system. Such systems make use of special modems as well as ISDN telephones. This considerably increases the risk of surges resulting from transient interference.

The TAE surge protection for ISDN lines can be installed to protect against these surges.

The basic version of the surface-mounted TAE-NFN socket has two-stage surge protection provided by a gas discharge tube and fast-acting suppression diodes.

The gas discharge tube achieves a high energy discharge; the suppression diodes ensure a low residual voltage. This setup protects the end terminals. The surge protection TAE junction boxes feature a monitoring function.

These monitor the connection of the voice voltage/operating voltage. As soon as this is interrupted or short-circuited, the output is switched to high resistance. This signal can be evaluated via a PLC input. A visual indication (green LED) instead of the remote signalling can be selected as an option.

### Drawing with dimensions:

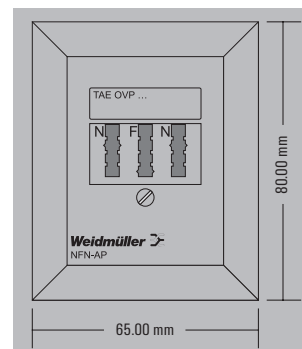

**For telecommunication interfaces**

- Surge protection for telecommunication interfaces
- High energy discharge with gas discharge tube
- Low residual voltage due to special suppressor diodes
- Overvoltage protection for analogue telephone connections
- Including TAE-NFN wall-mounted socket

**TAE OVP analog LED**

**TAE OVP analog LED**

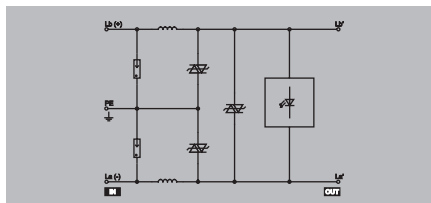

**TAE OVP ISDN LED**

**TAE OVP ISDN LED**

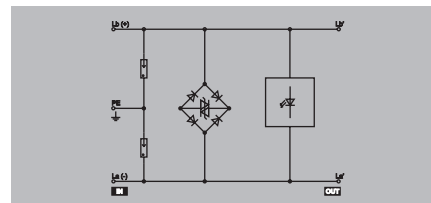

**Technical data**

Technical data	
Rated voltage (AC)	190 V
Max. continuous voltage, U <sub>c</sub> (AC)	190 V
Operating current, I <sub>max</sub>	0.45 A
Discharge current, max. (8/20 μs)	10 kA
Sparkover time / Drop-out time	≤ 5 ns
Wire-wire 8/20 μs, typically	100 V @5kA
Wire-PE 8/20 μs, typically	100 V @5kA
Optical function display	LED
Pollution severity	2
Surge voltage category	III
Ambient temperature (operational)	0 °C...+60 °C
Storage temperature	-25 °C...+85 °C
General data	
Rated voltage	190 V
Discharge current, nominal, per path, (8/20 μs)	4 kA
Discharge current, max. (8/20 μs)	10 kA
Sparkover time / Drop-out time	≤ 5 ns
Volume resistance	1.10 Ω
Limiting frequency (-3 dB) at load resistance	2 MHz
Approvals	
Approvals	CE; GOSTME25
Standards	

Rated voltage (AC)	190 V
Max. continuous voltage, U <sub>c</sub> (AC)	190 V
Operating current, I <sub>max</sub>	0.45 A
Discharge current, max. (8/20 μs)	10 kA
Sparkover time / Drop-out time	≤ 5 ns
Wire-wire 8/20 μs, typically	100 V @5kA
Wire-PE 8/20 μs, typically	100 V @5kA
Optical function display	LED
Pollution severity	2
Surge voltage category	III
Ambient temperature (operational)	0 °C...+60 °C
Storage temperature	-25 °C...+85 °C
General data	
Rated voltage	190 V
Discharge current, nominal, per path, (8/20 μs)	4 kA
Discharge current, max. (8/20 μs)	10 kA
Sparkover time / Drop-out time	≤ 5 ns
Volume resistance	1.10 Ω
Limiting frequency (-3 dB) at load resistance	2 MHz
Approvals	
Approvals	CE; GOSTME25
Standards	

Rated voltage (AC)	190 V
Max. continuous voltage, U <sub>c</sub> (AC)	190 V
Operating current, I <sub>max</sub>	0.45 A
Discharge current, max. (8/20 μs)	10 kA
Sparkover time / Drop-out time	≤ 5 ns
Wire-wire 8/20 μs, typically	100 V @5kA
Wire-PE 8/20 μs, typically	100 V @5kA
Optical function display	Green LED
Pollution severity	2
Surge voltage category	III
Ambient temperature (operational)	0 °C...+60 °C
Storage temperature	-25 °C...+85 °C
General data	
Rated voltage	190 V
Discharge current, nominal, per path, (8/20 μs)	4 kA
Discharge current, max. (8/20 μs)	10 kA
Sparkover time / Drop-out time	≤ 5 ns
Volume resistance	1.10 Ω
Limiting frequency (-3 dB) at load resistance	2 MHz
Approvals	
Approvals	CE; GOSTME25
Standards	

Dimensions	
Clamping range (nominal / min. / max.)	mm <sup>2</sup>
Height x width x depth	mm
Note	

Screw connection	
1.5 / 0.5 / 1.5	
30 / 65 / 80	
On-wall housing NFN	

Screw connection	
1.5 / 0.5 / 1.5	
30 / 65 / 80	
On-wall housing NFN	

**Ordering data**

Type	Qty.	Order No.
TAE OVP analog LED	1	8674020000

Type	Qty.	Order No.
TAE OVP analog LED	1	8674020000

Type	Qty.	Order No.
TAE OVP ISDN LED	1	8674010000

Note

Note

Note

**Accessories**

Note

Note

Note

# Installation instructions for data interfaces

The supply and earth lines of the protective modules should be kept short in order to achieve optimum protection for the data terminals.

Likewise, the transmission paths should also be kept as short as possible because the longer the line, the greater is the chance of interference having an effect.

Inserting surge protection increases the attenuation of the line and so changes the signal-to-noise ratio.

## Installation position

Protective modules are frequently installed at both ends of the line.

It is important to ensure that protected and unprotected lines are routed separately. Further, there should be some clearance between power lines and data lines. A common cable duct must be subdivided with metal partitions.

## Shielded lines for data interfaces

Systems involving several buildings should be designed with cable shielding capable of carrying current. These data lines often have two shields: one for carrying transient currents, the other as protection against coupled interference.

## Circuit concepts

High transmission frequencies place greater demands on surge protection in protective circuits for data interfaces. Gas discharge tubes are frequently the sole means of protection in these cases. However, the disadvantage of this is that the protection level is very high. Lower protection levels can be attained at high transmission frequencies by using special low-capacity suppressor diodes.



# Applications for data surge protection / LON™ termination

Surge protection technology from Weidmüller can also be used effectively in building services and industrial automation. Today, the universal **automation network LON™** is commonly used, worldwide.

**LON™** is the abbreviation for “**Local Operating Network**” and is also known as **LONWORKS®**. It was developed by the Echelon Corporation of Palo Alto, USA. Some 10,000 sensors and actuators can be linked to form an integrated building services automation network by means of a **LON™ network**.

The network topology and cabling of **LON™ networks** does not need to follow any particular structure. Star-type, ring, tree or classic series structures can be chosen as required. In practice this often results in free topologies based on existing structures in buildings or plants. in buildings or plants. A twisted 2-wire **LON™ LPT/FTT/TP78** line is often used.

The **MCZ OVP LON™** is used as surge protection for lines between different buildings. These arresters can be installed at the points marked in the circuit diagram with a “T”.

The recommended surge protection products for the **LON™ system** are installed at the building border in the first electrical cabinet. It is also advisable to incorporate a shielded line for these routes. This may then be held by a Weidmüller terminal clamp (KLBÜ).

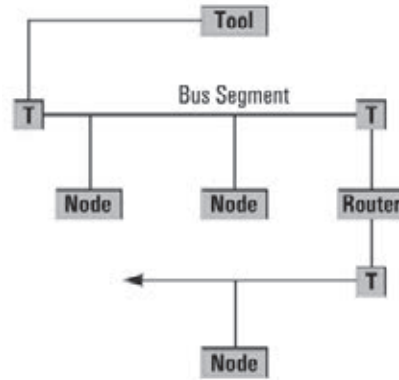

TP / XF Multidrop Bus Topology (J3)

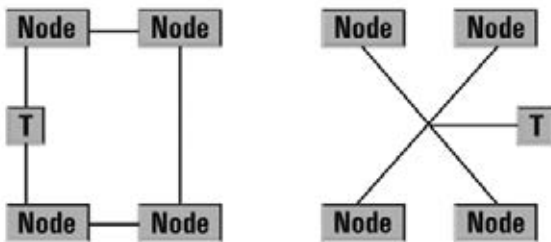

FT / LP Free Topology (J2)

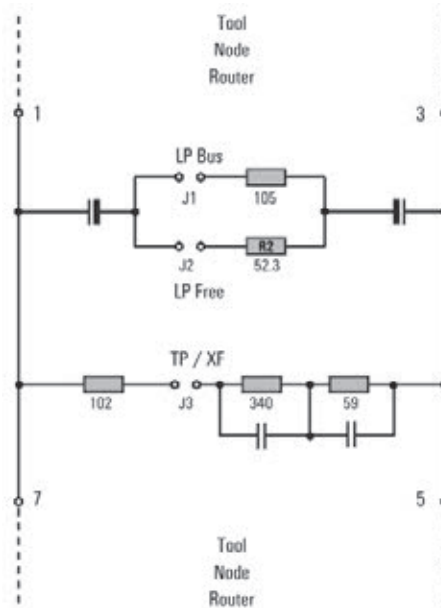

Circuit diagram of termination

# Applications for data surge protection / RS485 for 2- or 4-wire



D



Data from an oil well plant is to be transmitted via a Profibus data line (RS485 signal) to a control room.

With distances of up to 80 m it is advisable – in exposed locations – to install surge protection both before the oil well plant and before the Profibus module in the control room.

The robust design in the K21 housing means that this surge protection can be installed directly in situ.

The RS485 bus can be designed as a 2- or 4-wire system. A 4-wire application is shown opposite, with direct earthing for one station. In this case there is a connection between GND and earth. The other side, which is at a distance of approx 80, has a high-resistance earth via the integral gas discharge tube. For further information, see the internal surge protection circuit diagram below.

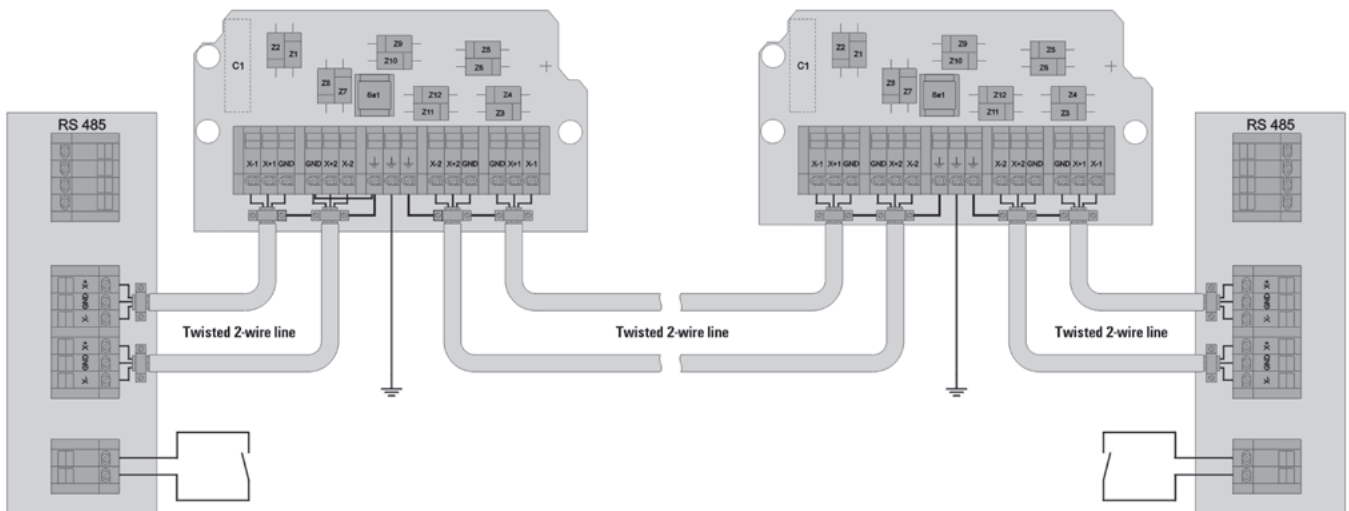
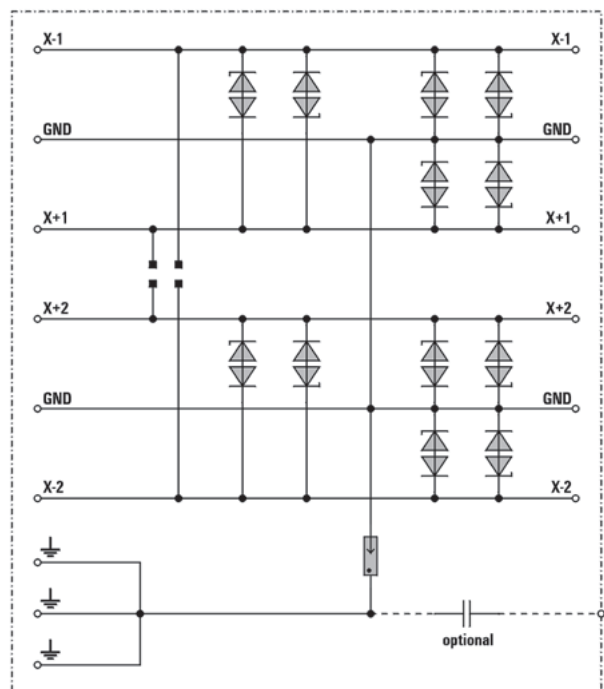

# Applications for data surge protection / RS485 for T-junction



Data is to be transmitted via a Profibus data line (RS485 signal). This data is sent to several Profibus systems. In this case it is advisable to split up the signal via a T-junction. The signal is looped through the surge protection and also branched. To do this, the two soldered connections on the PCB must be bridged. The robust design in the K21 housing means that this surge protection can be installed directly in situ.

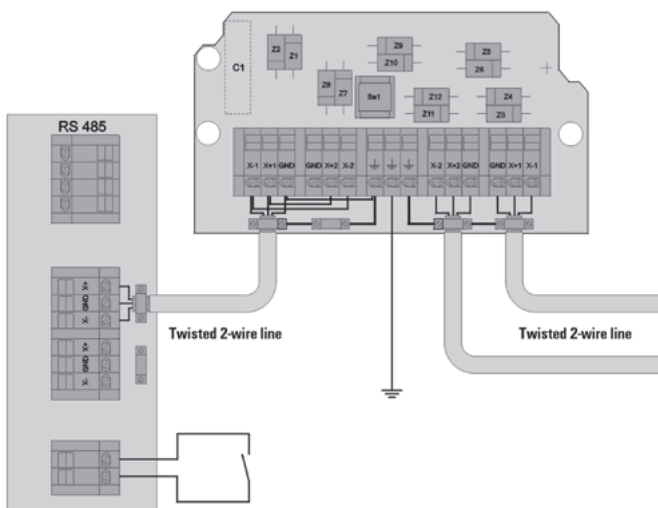
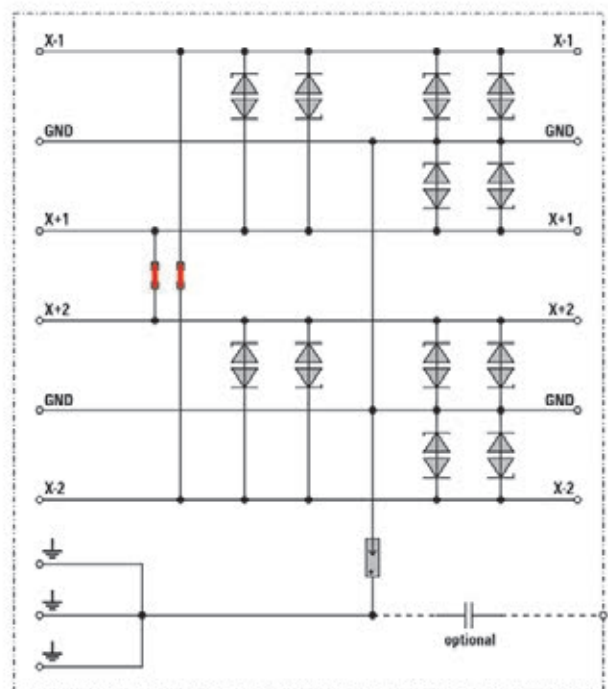

## LON™ application

A residential development with 70 housing units is to be networked for control purposes with a LON™ system. In practice free topologies often arise based on existing structures in buildings or plants. The twisted 2-wire LON TP78 line is to be used. An automatic control system will be installed in each building.

A co-generation power station receives requests for heating and hot water requirements via the LON™ network. In total, the transmission path exceeds 3000 m. The MCZ OVP surge protection for the LON™ system is installed at the building boundary, i.e. in the first distribution board for each building. In addition, the system is adapted to suit with the LON termination.

It is also advisable to incorporate a shielded line for these paths. This cable is then intercepted using a Weidmüller EMC or clamping bracket (KLBÜ).

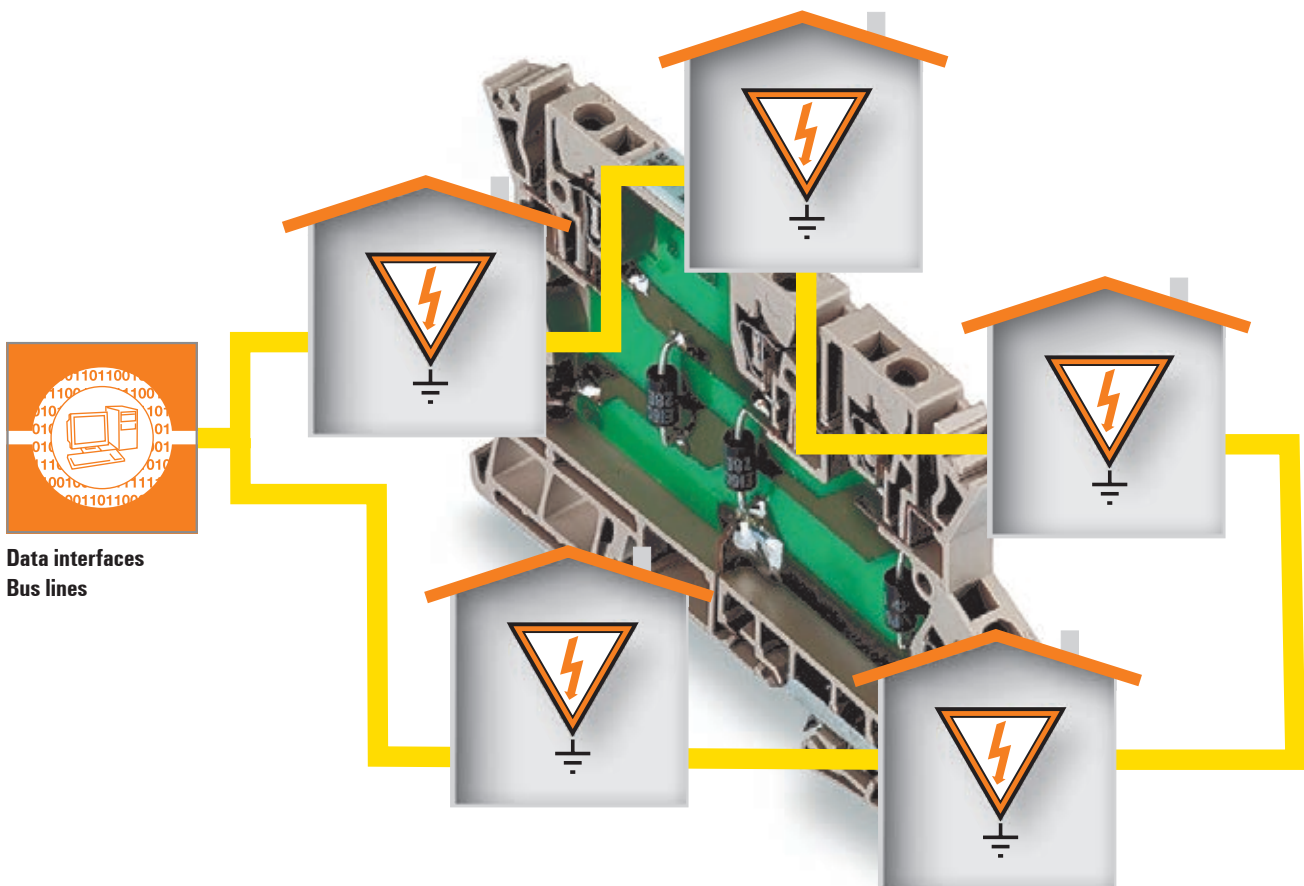

# Mains filter

---

Mains filter

Mains filter

E.2

---



# Mains filter

## WAVEFILTERS for simple radio interference suppression in the control cabinet

The WAVEFILTER series eliminates the time consuming work of screwing in mains filters. These filters are simply clipped on to the TS35 rail and connected to the device requiring suppression. The two-stage WAVEFILTER with overall width 22.5 mm in 1 A, 3 A, 6 A and 10 A versions offers high attenuation.

The WAVEFILTER, with current-compensating choke, is ideal for applications in drive technology and control/automation systems, e.g. for suppressing continuous interference types such as "noise" or "ripple" caused by interfering radiation from other systems, or interference from frequency converters and switch-mode power supplies. A short, low ohm mass connection is required for the WAVEFILTER to function perfectly. We recommend earthing all devices directly with the largest possible cross-section to a central earthing point in the control cabinet.

### Interference signals

We distinguish between two types of induced transient and continuous interference signals: symmetrical (differential mode) and asymmetrical (common mode). The symmetrical interference signals generate a voltage between the signal leads of the system. The asymmetrical interference voltages occur between the signal leads and earth.

The WAVEFILTER is suitable for attenuating both kinds of interference signal. In addition, WAVEFILTER 10 A also has an earthing conductor choke. This earthing conductor choke supports both attenuation on the earthing conductor for the filter and additional attenuation of asymmetrical interference voltages.

The WAVEFILTER has cULus approval.

### Insertion loss

#### WAVEFILTER 1 A

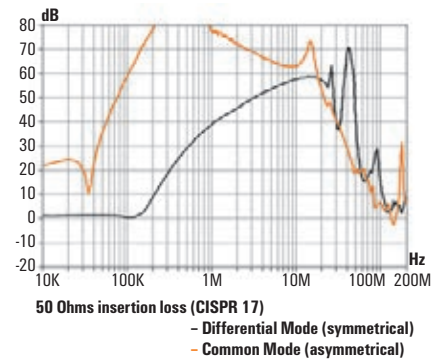

#### WAVEFILTER 3 A

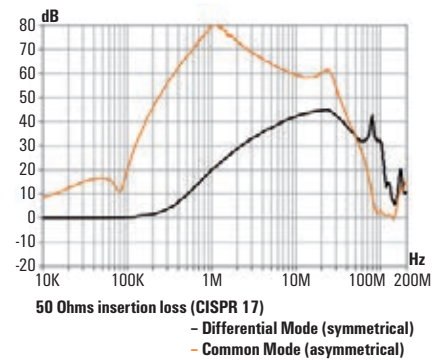

#### WAVEFILTER 6 A

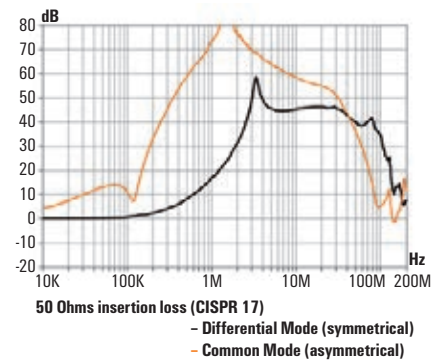

#### WAVEFILTER 10 A

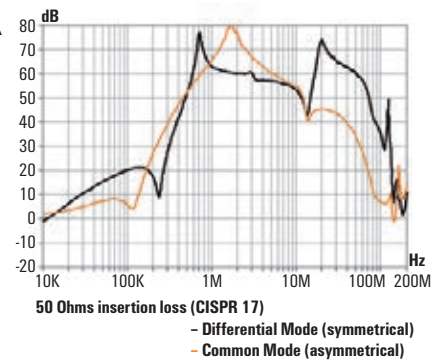

Installation height 112.4 mm



Installation height 92.4 mm



Dimensions

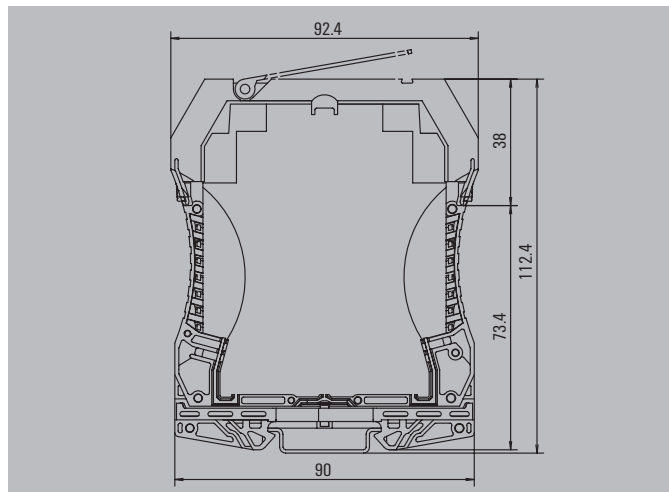

Dimensions

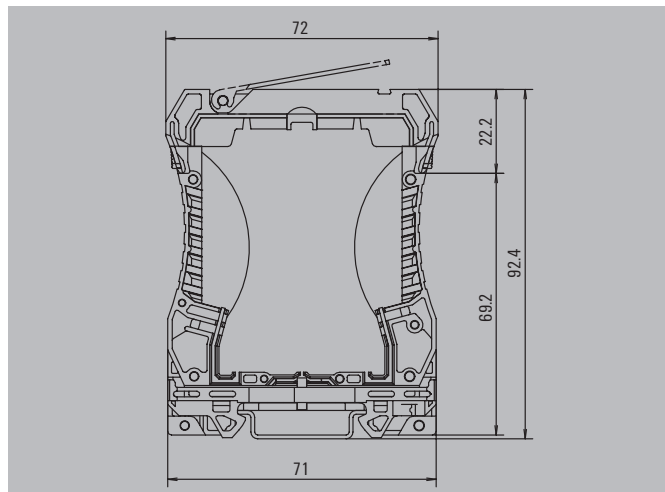

**Mains filter**

**Mains filter**

- Clips to TS 35
- High symmetrical and asymmetrical attenuation
- Suitable for voltages from 5 V to 250 V

**WAVEFILTER 1 A 250 V**

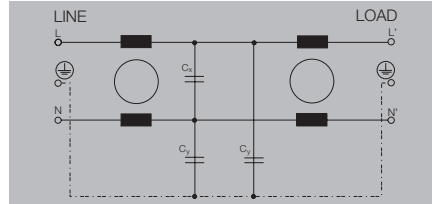

**WAVEFILTER 3 A 250 V**

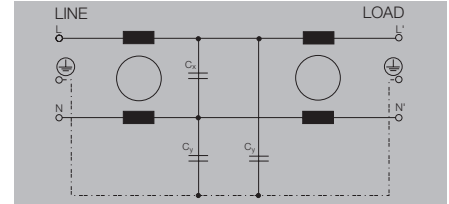

**Technical data**

Rated voltage  
 Rated current  
 Capacitance  
 Inductance L and L1  
 Leakage current at  $U_n$   
 Test voltage P/N-PE  
 Test voltage P-N  
 Ambient temperature (operational)

**Approvals**

Approvals  
 Standards

250 V  
 1 A  
 $C_x / C_y$ ; 33nF  
 10 mH  
 190  $\mu$ A  
 2000 V AC  
 1700 V DC  
 -20 °C...+40 °C

cURus; GOSTME25

250 V  
 3 A  
 $C_x / C_y$ ; 33nF  
 2 mH  
 190  $\mu$ A  
 2000 V AC  
 1700 V DC  
 -20 °C...+40 °C

cURus; GOSTME25

**Dimensions**

Clamping range (nominal / min. / max.) mm<sup>2</sup>  
 Height x width x depth mm

**Note**

2.5 / 0.5 / 2.5  
 73.4 / 22.5 / 73.4

See attenuation curve

2.5 / 0.5 / 2.5  
 73.4 / 22.5 / 73.4

See attenuation curve

**Ordering data**

Type	Qty.	Order No.
WAVEFILTER 1A	1	8614790000

Type	Qty.	Order No.
WAVEFILTER 3A	1	8614780000

**Note**

**Accessories**

**Note**

**Mains filter**

- Clips to TS 35
- High symmetrical and asymmetrical attenuation
- Suitable for voltages from 5 V to 250 V

**WAVEFILTER 6 A 250 V**

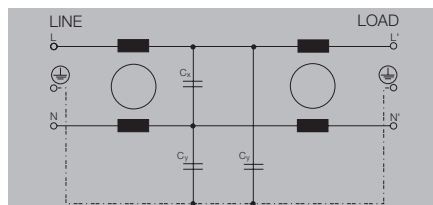

**WAVEFILTER 10 A 250 V**

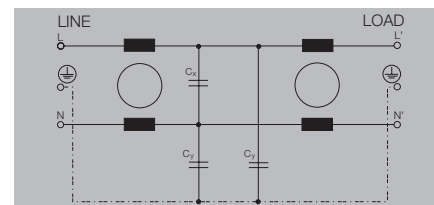

**Technical data**

Rated voltage  
 Rated current  
 Capacitance  
 Inductance L and L1  
 Leakage current at  $U_n$   
 Test voltage P/N-PE  
 Test voltage P-N  
 Ambient temperature (operational)

**Approvals**

Approvals  
 Standards

250 V  
 6 A  
 $C_x$ : 33 nF /  $C_y$ : 22 nF  
 0.8 mH  
 190  $\mu$ A  
 2000 V AC  
 1700 V DC  
 -20 °C...+40 °C

cURus; GOSTME25

250 V  
 10 A  
 $C_x$ : 470 nF /  $C_y$ : 4.7 nF  
 0.8 mH  
 190  $\mu$ A  
 2000 V AC  
 1700 V DC  
 -20 °C...+40 °C

cURus; GOSTME25

**Dimensions**

Clamping range (nominal / min. / max.) mm<sup>2</sup>  
 Height x width x depth mm

**Note**

2.5 / 0.5 / 2.5  
 73.4 / 22.5 / 73.4

See attenuation curve

2.5 / 0.5 / 2.5  
 73.4 / 22.5 / 73.4

See attenuation curve

**Ordering data**

Type	Qty.	Order No.
WAVEFILTER 6A	1	8614800000

Type	Qty.	Order No.
WAVEFILTER 10A	1	8614770000

**Note**

**Accessories**

**Note**





# Surge protection for photovoltaic systems

---

Surge protection for photovoltaic systems	Photovoltaic application example	F.2
---	----------------------------------	-----

---



## Surge protection prevents damage

Photovoltaic (PV) facilities for exploiting renewable energy are at great risk from lightning discharges because of their exposed location and large surface area. Damage to individual segments or the failure of the entire installation can be the consequence.

Lightning currents and surge voltages often cause damage to inverters and photovoltaic modules. These damages mean more expense for the operator of the photovoltaic facility. Not only are there higher repair costs but the productivity of the facility is also significantly reduced. Therefore, a photovoltaic facility should always be integrated into the existing lightning protection and grounding strategy.

To avoid these outages, the lightning and surge protection strategies in use must interact with one another. We provide you with the support you need, so that your facility functions smoothly and delivers its expected yield!

That's why you should safeguard your photovoltaic installation with lightning and overvoltage protection from Weidmüller:

- To protect your building and PV installation
- To increase system availability
- To safeguard your investment

### F





### Standards and requirements

The current standards and directives for overvoltage protection must always be taken into account in the design and installation of any photovoltaic system.

The European draft standard DIN VDE 0100 part 712/ E DIN IEC 64/1123/CD (Erection of low voltage systems, requirements for special equipment and facilities;



Area of roof after damaging event

photovoltaic power systems) and the international installation specifications for PV facilities – IEC 60364-7-712 – both describe the selection and installation of surge protection for PV facilities. They also recommend surge protection devices between the PV generators.

In its 2010 publication on surge protection for buildings with a PV installation, the Association of German Property Insurers (VdS) requires > 10 kW lightning and overvoltage protection in accordance with lightning protection class III.

To ensure that your installation is future-safe, it goes without saying that our components fully comply with all requirements.

Furthermore, a European standard for surge voltage protection components is in preparation. This standard will specify to what extent surge voltage protection must be designed into the DC side of PV systems. This standard is currently prEN 50539-11.

A similar standard is currently already in force in France – the UTE C 61-740-51. Weidmüller's products are currently being tested for compliance with both standards so that they can provide an even higher level of safety.



## Superior surge protection from Weidmüller

Our surge protection modules in Class I and Class II (B and C arresters) ensure voltage occurrences are quickly limited and that the current is safely discharged. This allows you to avoid expensive damages or the potential for complete power failure in your photovoltaic facility.

For buildings with or without lightning protection systems – we have the right product for every application! We can deliver the modules as you require – fully customised and pre-wired into housings.

### Deploying surge protection devices (SPDs) in photovoltaic systems

Photovoltaic energy is a vital component of the overall energy production from renewable energy sources. There are a number of special characteristics that need to be considered when deploying surge protection devices (SPDs) in photovoltaic systems. Photovoltaic systems have a DC voltage source, with specific characteristics. The system concept must therefore take these specific characteristics into consideration and co-ordinate the use of SPDs accordingly. For instance SPD specifications for PV systems must be designed both for a maximum no-load voltage of the solar generator (VOC STC = voltage of the unloaded circuit under standard test conditions) as well as with regard to ensuring maximum system availability and safety.

### External lightning protection

Owing to their large surface area and generally exposed installation location, photovoltaic systems are particularly at risk from atmospheric discharges – such as lightning. At this point there is a need to differentiate between the effects of direct lightning strikes and so-called indirect (inductive and capacitive) strikes. On the one hand the necessity for lightning protection depends on the normative specifications of the relevant standards and on the other hand, the necessity for lightning protection depends on the normative specifications of the relevant standards. On the other hand, it depends on the application itself, in other words, depending on if it is a building or a field installation. With building installations a difference is drawn between the installation of a PV generator on the roof of a public building – with an existing lightning protection system – and the installation on the roof of a barn – without a lightning protection system. Field installations also offer large potential targets due to their large area module arrays; in this case, an external lightning protection solution is recommended for this type of system to prevent direct lightning strikes.

Normative references can be found in IEC 62305-3 (VDE 0185-305-3), Supplement 2 (interpretation according to lightning protection level or risk level LPL III) [2] and Supplement 5 (lightning and surge protection for PV power systems) and in the VdS Directive 2010 [3], (if PV systems > 10 kW, then lightning protection is required). In addition, surge protection measures are required. For instance, preference should be afforded to separate air-termination systems to protect the PV generator. However, if it is not possible to avoid a direct connection to the PV generator, in other words the safety separation distance cannot be maintained, then the effects of partial lightning currents must be taken into consideration. Fundamentally, shielded cables should be used for the main lines of generators to keep induced overvoltages as low as possible. In addition, if the cross-section is sufficient (min. 16 mm<sup>2</sup> Cu) the cable shielding can be utilised to conduct partial lightning currents. The same applies to the utilisation of closed metal housings. Earthing must be connected at both ends of cables and metal housings. That ensures that the main lines of the generator fall under LPZ1 (Lightning Protection Zone); that means that a SPD type 2 suffices. Otherwise, an SPD type 1 would be required.

### Utilisation and correct specification of surge protection devices

In general, it is possible to consider the deployment and specification of SPDs in low voltage systems on the AC side as standard procedure; however, the deployment and the correct design specification for PV DC generators still remains a challenge. The reason is firstly a solar generator has its own special characteristics and, secondly, SPDs are deployed in the DC circuit. Conventional SPDs are typically developed for alternating voltage and not direct voltage systems. Relevant product standards [4] have covered these applications for years, and these can fundamentally also be applied to DC voltage applications. However, whereas previously relatively low PV system voltages were realised, today these are already achieving approx. 1000 V DC in the unloaded PV circuit. The task is to master system voltages of that order with suitable surge protection devices. The positions at which it is technically appropriate and practical to position SPDs in a PV system depends primarily on the type of system, the system concept and the physical surface area. Figures 2 and 3 illustrate the principle differences: Firstly, a building with external lightning protection and a PV system mounted on the roof (building installation); secondly, an expansive solar energy system (field installation), also fitted with an external lightning protection system. In the first instance – because of the shorter cable lengths – protection is merely implemented at the DC input of the inverter; in the second case SPDs are installed in the terminal box of the

solar generator (to protect the solar modules) as well as at the DC input of the inverter (to protect the inverter). SPDs should be installed close to the PV generator as well as close to the inverter as soon as the length of cable required between the PV generator and the inverter extends beyond 10 meters (Figure 2). The standard solution to protect the AC side, meaning the inverter output and network supply, must then be achieved by using type 2 SPDs installed at the inverter output and – in the case of a building installation with external lightning protection at the mains feed-in point – equipped with an SPD type 1 surge arrester.

### Special characteristics on the DC solar generator side

Until now, protection concepts on the DC side always used SPDs for normal AC mains voltages, whereby L+ and L- respectively were wired to earth for protection. This meant that the SPDs were rated for at least 50 percent of the maximum solar generator no-load voltage. However, after a number of years, insulation faults can occur in the PV generator. As a consequence of this fault in the PV system, the full PV generator voltage is then applied to the non-faulty pole in the SPD, and results in an overload event. If the load on SPDs based on metal-oxide varistors from a continuous voltage is too high, this can potentially result in their destruction or trigger the disconnecting device. In particular, in PV systems with high system voltages, it is not possible to completely exclude the possibility of a fire developing due to a switching arc that is not extinguished, when the disconnection device is triggered. Overload protection elements (fuses) used upstream are not a solution to this probability, as the short-circuit current of the PV generator is only slightly higher than that of the rated current. Today, PV systems with system voltages of approx. 1000 V DC are increasingly being installed to keep power losses as low as possible.

To ensure that SPDs can master such high system voltages the star connection consisting of three varistors has proven reliable and has become established as a quasi-standard (Figure 4).

If an insulation fault occurs two varistors in the series still remain, which effectively prevents the SPD from being overloaded.

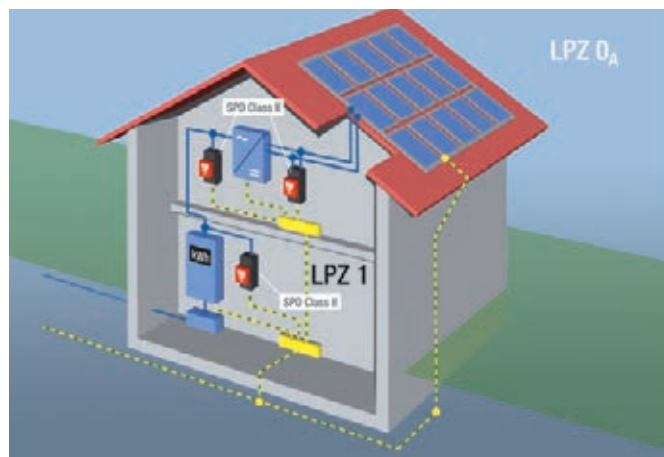

Figure 1: Schematic diagram from standard IEC 60364-7-712

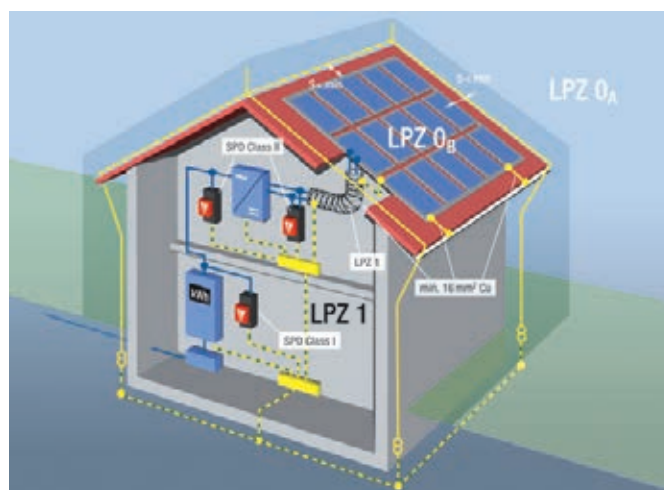

Figure 2: Building installation with external lightning protection system, in compliance with air termination distances

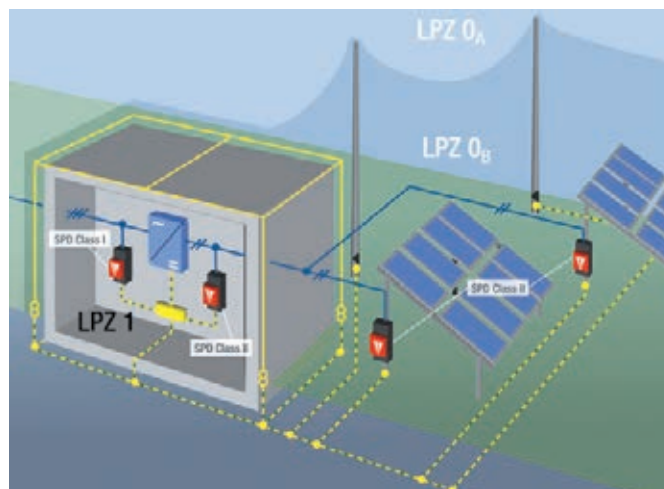

Figure 3: Field installation with external lightning protection system

## Photovoltaic application example

To summarise: protective circuitry with absolutely zero leakage current is in place and an accidental activation of the disconnecting mechanism is prevented. In the scenario described above, the spread of fire is also effectively prevented. And at the same time, any influence from an insulation monitoring device is also avoided. So if an insulation malfunction occurs, there are always two varistors still available in the series. In this way, the requirement that earth faults must always be prevented, is met. Weidmüller's SPD type 2 arrester VPU II 3 1,000 V DC to UCPV mode +/-, -/PE, +/-PE = 1,000 V DC provides a well tested, practical solution and has been tested for compliance with all current standards (UTE C 61-740-51 and prEN 50539-11) (Figure 4). In this way, we offer the highest degree of safety available for use in DC circuits.

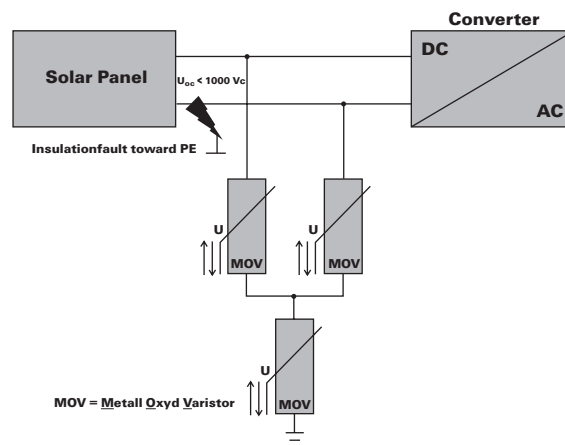

Figure 4: Y-shaped protective circuitry with three varistors

## F

### Practical applications

As already stated, a difference is drawn between building and field installations in practical solutions. If an external lightning protection solution is fitted, the PV generator should preferably be integrated into this system as an isolated arrester device system. IEC 62305-3 specifies that the air termination distance must be maintained. If it cannot be maintained then the effects of partial lightning currents must be taken into consideration.

On this point the standard for protection against lightning IEC 62305-3 Supplement 2 states in Section 17.3: 'to reduce induced overvoltages shielded cables should be used for the main lines of the generator'. If the cross-section is sufficient (min. 16 mm<sup>2</sup> Cu) the cable shielding can also be used to conduct partial lightning currents. Supplement (Figure 5) - Protection against lightning for photovoltaic systems – issued by the ABB (Committee for Lightning Protection and Lightning Research of the (German) Association for Electrical, Electronic and Information Technologies) states that the main lines for the generators should be shielded. This means that lightning current arresters (SPD type 1) are not required, although surge voltage arresters (SPD type 2) are necessary on both sides. As Figure 5 illustrates, a shielded main generator line offers a practical solution and achieves LPZ 1 status in the process. In this manner, SPD type 2 surge arresters are deployed in compliance with standards specifications.

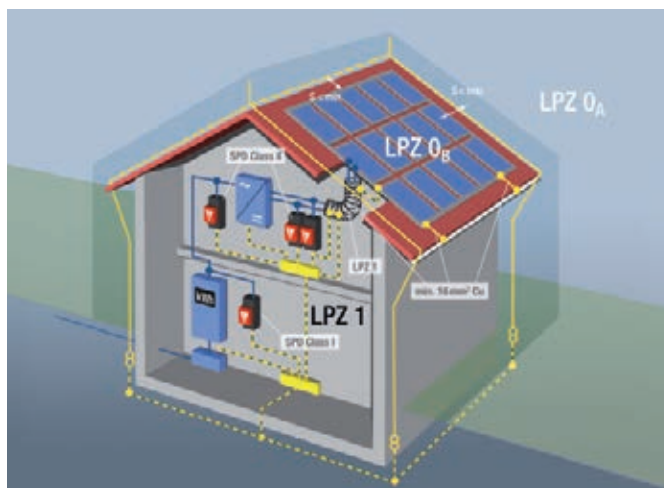

Figure 5: Building installation with external lightning protection, not in compliance with air termination distances

## Ready-to-fit solutions

To ensure on-site installation is as straightforward as possible Weidmüller offers ready-to-fit solutions to protect the DC and AC sides of inverters. Plug-and-play PV boxes reduce the installation time. Weidmüller will also perform customer-specific assemblies at your request. More information is available at [www.weidmueller.com](http://www.weidmueller.com)

### Note:

**Country-specific standards and guidelines must be observed**

### Literature

- [1] DIN VDE 0100(VDE 0100) part 712: 2006-06, Requirements for special installations or locations. Solar photovoltaic (PV) power supply systems
- [2] DIN EN 62305-3 (VDE 0185-305-3) 2006-10 Lightning Protection, Part 3: Protection of facilities and people, supplement 2, interpretation according to protection class or risk level III LPL, Supplement 5, lightning and surge protection for PV power systems
- [3] VdS Directive 2010:2005-07 Risk-oriented lightning and surge protection; Guidelines for loss prevention, VdS Schadenverhütung Verlag (publishers)
- [4] DIN EN 61643-11 (VDE 675-6-11): 2007-08 Low-voltage surge protective devices – Part 11: surge protective devices for use in low-voltage power systems – requirements and tests
- [5] IEC 62305-3 Protection against lightning – Part 3: Physical damage to structures and life hazard
- [6] IEC 62305-4 Protection against lightning – Part 4: Electrical and electronic systems within structures
- [7] prEN 50539-11 Low-voltage surge protective devices – Surge protective devices for specific application including d.c. – Part 11: Requirements and tests for SPDs in photovoltaic applications
- [8] French product standard for surge protection in the DC area UTE C 61-740-51

### VPU II 3 1000 V DC PV



- A 1,000 V surge voltage arrester for use on the DC side

More information in Chapter C.

### VPU II 4 280 V / 40 kA



- 230/400-V surge protection arrester
- Suitable for TN-CS power system
- High energy absorption with  $I_{max}$ : 40 kA per element

More information in Chapter C.

### VPU-I-LCF-Serie



- 230/400-V "Combined lightning current and surge arresters", free from leakage current
- 1-pole version
- High energy absorption
- Option for V-shaped conductor connection

More information in Chapter C.



### Modular use of our surge protection components

If a lightning protection system is already present on the building, this must be at the highest point of the entire system. All modules and cables of the photovoltaic installation must be installed below the air terminations. Separation distances of at least 0.5 m to 1 m must be maintained (depending on risk analysis from IEC 62305-2).

The external Type I lightning protection (AC side) also requires the installation of a Type I lightning arrester in the electrical supply of the building. If no lightning protection system is present, then Type II arresters (AC side) are sufficient for use.

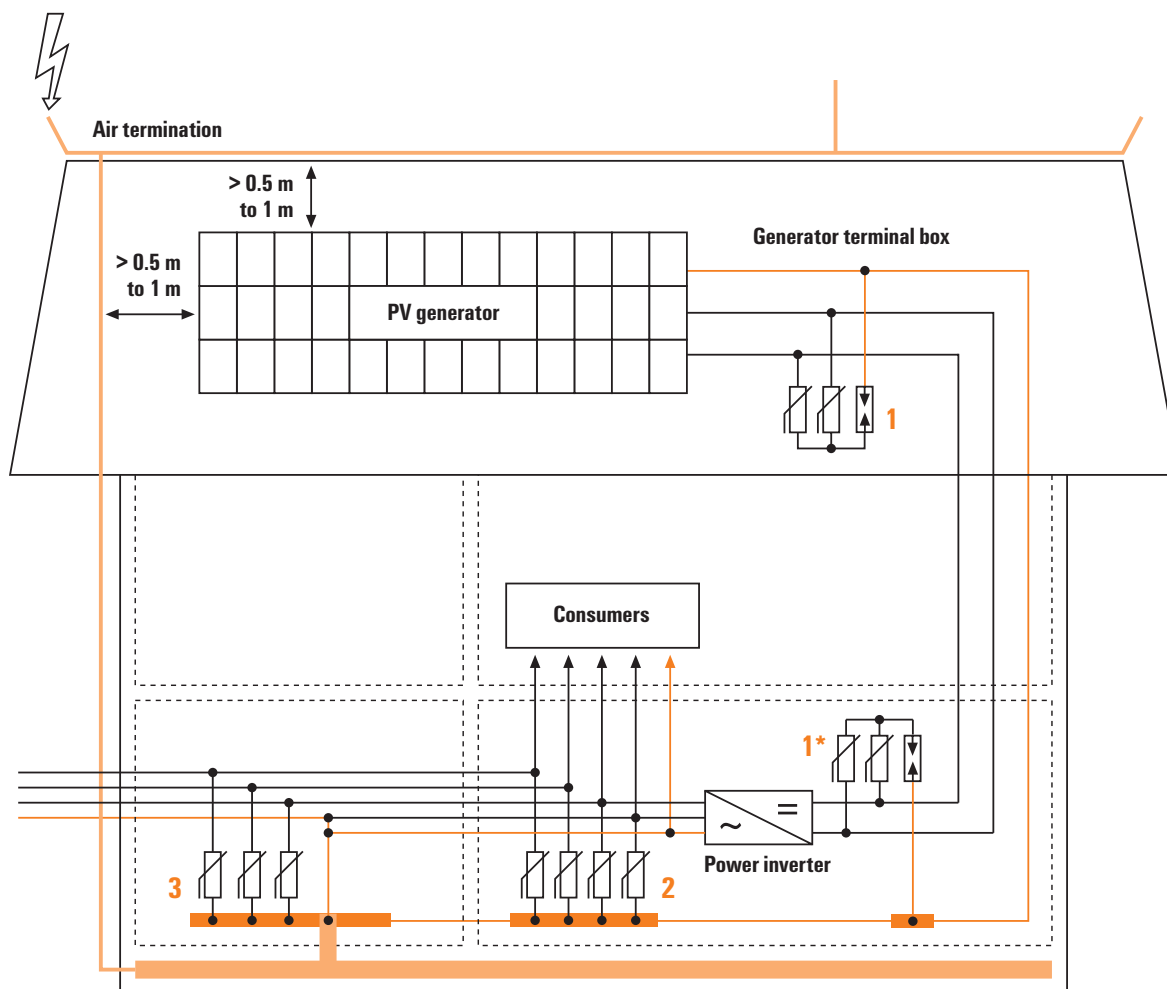

#### 1 VPU II 3 1000 V DC PV

Y-coupling

#### 1\* VPU II 3 1000 V DC PV

For long distances > 10 m between the PV generator and inverter

#### 2 VPU II 4 280 V / 40 kA

For long distances > 10 m between the inverter and the house power feed

#### 3 VPU-I-LCF-Serie

In the event of an existing lightning protection system

# The basics of lightning and surge protection

<b>The basics of lightning and surge protection</b>	Prevention is better than cure	W.2
	What are overvoltages?	W.4
	How do overvoltages occur?	W.5
	How do we achieve surge protection?	W.8
	Surge protection concept	W.9
	Classification and protective zones	W.11
	Lightning protection levels	W.12
	Guidelines SEV 4022	W.13
	Network forms	W.14
	3+1 circuit: universal solution	W.16
	General installation advice	W.18
	Surge protection installation instructions	W.21
	Standard texts for tenders	W.25
	Office building with lightning protection	W.26
	Industrial building with lightning protection	W.27
	Components for Surge protection	W.28
	Test criteria	W.31
	Electromagnetic compatibility	W.32
	Questions and answers concerning surge protection	W.34
	Glossary	W.38
	Country-specific standards and directives	W.43
	Summary of standards and regulations	W.45

# Prevention is better than cure



This is true, not only for people, but also for the “health” of your electrical and electronic components and equipment. Cost-effective strategies demand an investment in surge protection. Such an investment would only be a fraction of the amount of possible damage. The shut down of a manufacturing plant because of the failure of a controller or the collapse of industrial data transmission can be very costly. But the significant overhead in repairing the problem is not the only factor. You must also take into account the system down times. The lifespan of your components (mean time between failure) will also be shortened.

Surge voltages present a significant danger and this can be demonstrated in many other ways than the examples given in damage statistics from property insurers.

All electrical equipment is potentially threatened by surge voltages: this includes free-standing high-voltage switching facilities and also electronic micro-components. For low voltages, this risk is predominant in the fields of power supply, measure and control technology, telecommunications, and data transmission. We therefore work with protective strategies and systems when designing lightning and surge protection. Only an entire system can provide effective protection for all areas of power, signals and data and we offer an ideal form of surge protection for all these applications fields.

Surge protection has become an area of increasing significance. On the one hand, electrical and electronic components continue to get smaller. On the other hand, the levels of automation in the industrial and consumer electronics sectors are continuing to rise.

The safety clearances for insulation decrease as do the tolerance limits. Electronic circuits function at low voltage levels of only several hundred volts. Thus surge voltages can present a significant danger.

The German “Law on electromagnetic compatibility in devices” establishes the proper EMC-compliant design and layout for electrical and electronic devices.

Surge protection is an element of these EMC measures and implementation of this protection is described in a variety of IEC/VDE standards. Such measures can also help in obtaining the CE mark of approval.

To guarantee the safety of consumers, different product standards offer a method for ensuring a global product standard.

Causes of surge voltage	Protection measures described in			Installation of protective devices described in
	DIN V ENV 61024-1	DIN VDE 0185-103	E DIN VDE 0100 Part 443	DIN V VDE V 0100-534: 1999-04
Direct lightning strike	X	X		X
Remote lightning strike		X	X	X
Lightning fields		X		X
Switching operations			X	X

W



For energy protection, these are IEC 61643-1 and IEC 61643-11. For protection of measurement and control systems, IEC 61643-21 is relevant. These standards provide the rules which are globally valid for all manufacturers of surge protection components.

The standards also provide helpful support for users. IEC 61643-12 is valid for the installation of energy-protection components and IEC 61643-22 is valid when protecting measurement and control systems. IEC 62305 is the overall guideline for all applications when dealing with lightning and surge protection. This standard covers all the parameters: risk analysis, external and internal lightning protection.

The subject of surge protection is rather complicated and requires special knowledge. Therefore, this catalogue provides you with some helpful information. And if you want to know more, simply contact us. We are happy to help and advise you.

## What are overvoltages?

# What are overvoltages?

Surges are extremely high voltages that damage or even completely destroy insulation and hence impair or completely disrupt the function of electrical and electronic components of all kinds.

Every electrical component is provided with insulation to isolate the electrical voltage from earth or other voltage-carrying parts. The insulation strength is dependent on the rated voltage and the type of electrical component, as stipulated by the IEC/VDE regulations. It is tested by applying the prescribed voltages for a defined period of time. If the test voltage is exceeded in operation, the safety effect of the insulation is no longer guaranteed. The component can be damaged or completely ruined. Surges are voltage pulses that are higher than the test voltage, and these could detrimentally affect an electrical component or system. This means that components with a high rated voltage may be capable of withstanding a surge voltage. But components with a lower rated voltage would be very much at risk from the same surge. An overvoltage allowable in an electric motor can spell disaster for an electronic circuit! Permanently higher voltages also occur with the 50/60 Hz mains frequency. These voltage can be coupled and can also occur as a result of faulty switching operations. The resulting continuous interference voltages are another reason for installing overvoltage protection.

Individual surge pulses, which have a high frequency because of their physical formation, have a current rise that is about ten thousand times steeper compared with 50 Hz voltage. If the current rise time in the 50/60 Hz range is 5 ms, then for an overvoltage it is around 1  $\mu$ s.

These surges are designated as “transient” voltages. This means that they are short-lived, temporary oscillations. Their shape and frequency depends on the impedance of the circuit.

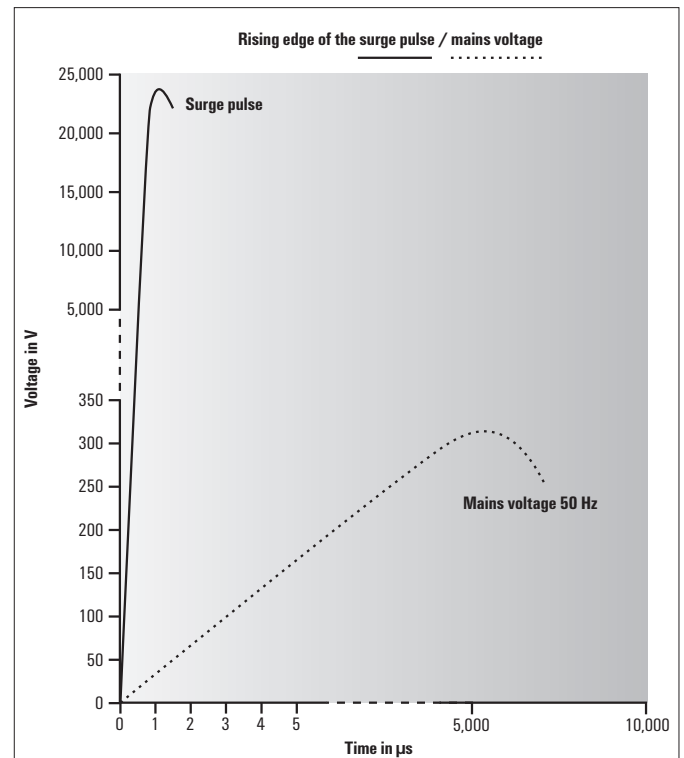

Edge behaviour between a 50 Hz sine wave and surge pulse

# How do overvoltages occur?

Surges are primarily caused by:

- Transient switching operations
- Lightning due to atmospheric discharges
- Electrostatic discharges
- Faulty switching operations

## Lightning

Bolts of lightning comprise extremely high currents. They can cause a large voltage drop and a large rise in potential, even in well-earthed buildings or systems, despite low earthing resistances.

This can then result in a galvanic, inductive or capacitive coupling of surge voltages within the circuits of electrical or electronic facilities. Any insulation will also be penetrated. So, in reality, there are no electrical isolation methods which provide reliable protection against surge voltages. Analogue converters, relays or opto modules are important for separating potentials, but they are definitely not surge protection components.

A natural lightning strike consists of a main discharge and a time-shifted post discharge. The strength of this second discharge is usually far below the energy level of the main discharge. Both discharges, however, have enough power to cause significant damage.

Our table below shows results from a natural lightning strike and a lightning current generator which simulates a lightning pulse.

The various forms of coupling must be considered in order to understand the effects of lightning.

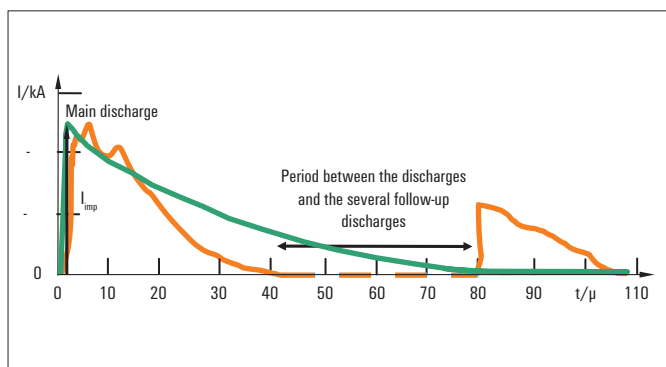

The discharge curve of natural lightning (red) and a simulated lightning strike from lightning current generator (green)

## Conductive coupling



Surges are transferred directly into circuits via common earthing impedances. The magnitude of the overvoltage depends on the amperage of the lightning and the earthing conditions. The frequency and the wave behaviour are mainly determined by the inductance and the speed of the current rise. Even distant lightning strikes can lead to overvoltages in the form of travelling waves, which affect different parts of electrical systems by way of conductive coupling

## Inductive coupling

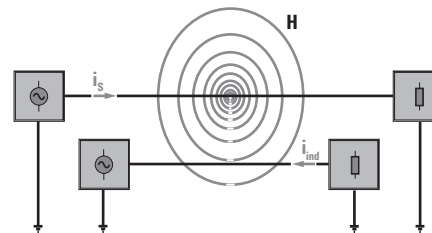

A high-amperage lightning strike generates a strong magnetic field. Starting from here, overvoltages reach nearby circuits by means of an induction effect (e.g. directly earthed conductor, power supply lines, data lines, etc.). According to the transformer principle, the coupling of induced voltages is considerable owing to the high-frequency current  $di/dt$  – even when primary and secondary windings consist of only a single winding each, i.e. the inductance is low.

## Capacitive coupling

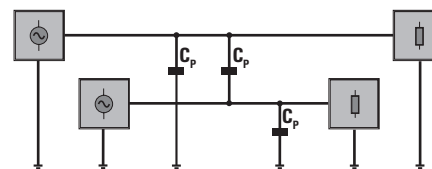

A capacitive coupling of overvoltages is also possible. The high voltage of the lightning generates an electric field with a high field strength. The transport of electrons can cause a capacitive decay to circuits with lower potentials and raise the potential concerned to an overvoltage level.

## How do overvoltages occur?

### Radiation coupling

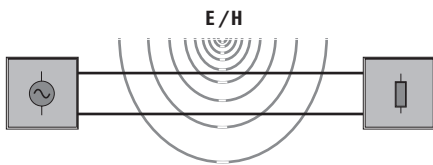

Electromagnetic wave fields (E/H field), that also ensue during lightning (distant field condition, E/H field vectors perpendicular to each other), affect conductor structures in such a way that coupled overvoltages must be expected even without direct lightning strikes. Permanent wave fields from strong transmitters are also able to cause coupled interference voltages in lines and circuits.

### Switching operations – transients

More often, it is switching operations that cause interference rather than lightning. High-amperage shutdowns in the mains in particular can generate considerable overvoltages (e. g. welding equipment). Switching operations generate overvoltages because, due to their construction, switching contacts that switch the current on or off do not operate in synchronisation with the current zero of an alternating current. This means that in the majority of cases there is a very rapid change of current, from a high value to zero ( $di/dt$ ). Owing to the impedances in the circuit concerned, this leads to transient overvoltages with high-frequency oscillations and high voltage peaks. These can reach electrical components by conductive, inductive or capacitive means and endanger or damage them. The situation is similar in the case of short-circuits in the mains because these also represent a rapid switching operation.

### Electrostatic discharges – ESD

Electrostatic discharges (ESD) caused by frictional charges are well known. You can experience them when getting out of a car or walking across a carpet. These discharges can be over 10,000 volts in strength. We speak of ESD when these discharge to a lower potential. If such a charge strikes, for example, electronic components, then these can be completely ruined. Special care is taken, for example, with ESD issues when manufacturing electronic circuit boards.

### Faulty switching operations

Again and again, we experience faulty switching operations in the 50/60 Hz mains. These can be caused by a failed power supply unit controller or incorrect wiring in a panel. The relatively high voltages that can occur as a result also represent dangerous overvoltages. Protection against these is vital.

### Description of interference voltages

Surge voltages that occur between live conductors, or between a live conductor and the neutral conductor, are called transverse voltage or symmetric interference [UQ].

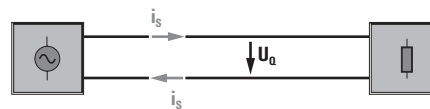

Surge voltages that occur between a live conductor and the PE conductor are called longitudinal voltage or asymmetric interference [UL].

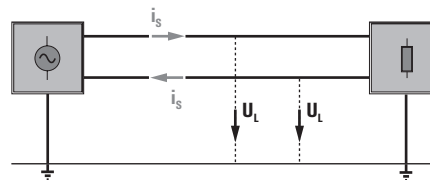

### The forms of interference voltage

Coupled transient surge voltages are basically either symmetric (differential-mode interference) or asymmetric (common-mode) interferences, which are measured as longitudinal or transverse voltages.

#### Normal-mode interference (symmetrical interference)

A voltage between supply and return conductor, differential mode voltage/current. Occurs mainly at low interference frequencies in the existing lines. The interference current causes an interference voltage  $U_0$  directly at the interference sink (between the input terminals). With galvanic or inductive coupling, both the effective sources and the interference sources are connected serially. The load and interference sources are connected in series as an inductive (magnetic field) or conductive coupling (common impedance). In symmetrical circuits (non-earthed or virtual potential earthed), the normal-mode interference occurs as symmetrical voltages.

In unsymmetrical circuits (earthed one side), the normal-mode interference occurs as unsymmetrical voltages.



### Transverse voltage $U_Q$ (normal-mode voltage)

This is a transient coupled interference between two active conductors. For asymmetric circuits with ground potential, the transverse voltage is equal to the longitudinal voltage [ $U_Q = U_L$ ].

A remedy or limitation may be achieved by twisting the corresponding wires together and shielding or multiple shielding with cable sheath. This reduces the induction of transverse voltages.

### Common-mode interference (unsymmetrical interference)

Voltage between conductor and reference potential (earth), common-mode voltage/current. Mainly caused by a capacitive coupling (electrical field).

Therefore, significant common-mode interference currents only flow at higher interference frequencies. The interference voltage at the potentially susceptible device is caused by different voltage drops at the supply and return conductors (in each case between input terminal and reference earth). The source of interference can be between a signal wire and reference conductor increase in reference potential between separate earths.

In symmetrical circuits, common-mode interference occurs as asymmetrical voltages between the d.c. offset of the circuit and the reference earth. The forward and return conductors have the same interference voltages compared to the reference ground. In unsymmetrical circuits, common-mode interference occurs as unsymmetrical voltages between the individual conductors and the reference earth.

### Longitudinal voltage $U_L$ (common-mode voltage)

A coupled transient interference voltage between an active conductor and the earth potential. As a rule, the longitudinal voltage is higher than the transverse voltage (transverse voltage is lower owing to cable shielding and twisting). Longitudinal voltages caused by lightning currents on cable shielding can assume quite high values, especially in the case of long lines entering a building from the outside.

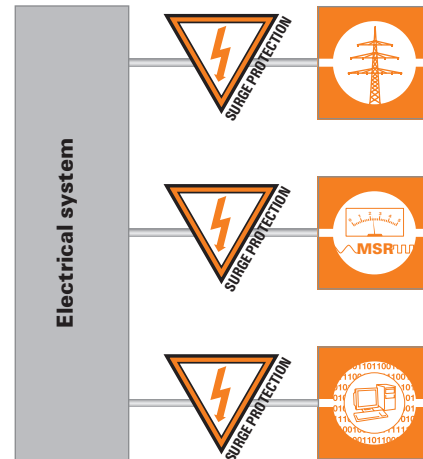

### Consequences

The impedances and stray capacitances are equal in ideal circuits. This means that the currents in the supply and return conductors generated by coupled overvoltages are also equal and so do not generate any interference voltage. However, in practice the impedances and stray capacitances in the supply and return conductors are different. This results in unequal currents which cause different voltages to earth in the supply and return conductors.

This means that the unequal impedances lead to the common-mode voltage becoming, for the most part, a normal-mode voltage because of the dissimilarity in the voltages to earth of the supply and return conductors.

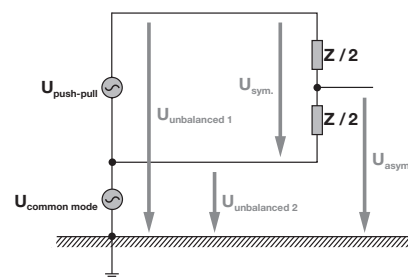

# How do we achieve surge protection?

We have to consider surge protection from two points of view:

- General protective measures during the planning and construction of buildings and electrical installations.
- Special protective measures realised by the installation of additional surge protection components.

## Planning buildings and electrical installations

Some primary measures to prevent or limit surge voltage damages can be incorporated into buildings and electrical/electronic facilities right from the start. Although such measures can achieve only basic protection, they can save some of the costs involved when it comes to planning an effective, complete protection concept. Beginning with the first phase of construction, it is very important to set up an earthing or equipotential bonding facility of sufficient size. Only this will ensure full equipotential bonding in the event of a malfunction.

Thus when speaking of lightning protection, we only refer to lightning protection equipotential bonding. All cables are connected to the lightning protection equipotential bonding: including the power supply, measurement and control signals, telephone lines, and even the water and gas lines. When planning the electrical installation, care must be taken to ensure that electrical systems with dissimilar rated voltages are kept separate. Corresponding protection zones can then be set up and this leads to cost-savings in the surge protection.

Furthermore, the physical separation or shielding of lines that can influence each other is a good way to achieve maximum electrical isolation. Another good option is to split up the individual phases of three-phase systems corresponding to their functions, e.g. one phase only for the supply to instrumentation and control systems.

Of course, all these primary measures do not achieve complete protection. To do this, you must install additional protective components.

## Surge protection components

Surge voltages are kept away from at-risk electrical components by first reducing them to a harmless dimension before they reach the components.

The quick reaction times of surge arresters are used to provide this protection. They must respond during the high-frequency rising phase of the overvoltage, i.e. before a dangerous value has been reached, and quench the overvoltage. The response time lies in the nanoseconds range.

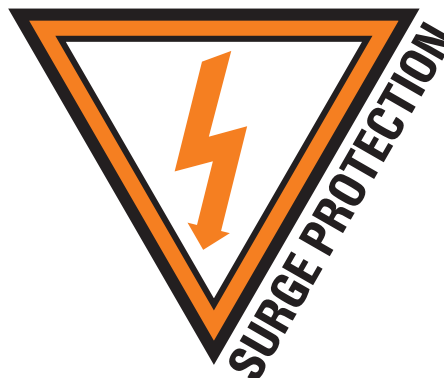

Naturally the surge protection components must be able to withstand very high currents, since a surge can, under certain circumstances, deliver several thousand amperes. At the same time, no excessive (i.e., dangerous) residual voltages should remain, even if the operating current is very high. So surge protection components must exhibit a very low resistance discharge behaviour.

In addition, it is absolutely essential that the surge protection component is very quickly available again in electrical terms after the surge has been quenched by earthing it. This is necessary to ensure that the function of the circuit is guaranteed.

Good surge protection is characterised by:

- Fast response behaviour
- High current-carrying capacity
- Low residual voltage
- Good reactivation time

Weidmüller can supply protective components that fulfil these criteria. Depending on the application, these usually consist of a combination of individual components, as described in the chapter on surge components.

Which combination of protective components is available for the respective application is described in the chapters B, C and D.

It will become clearer, from the set-up of the protective elements, how and where a product is used.

The first protection mechanism is always installed at the building entrance, so that the initial coupling interference can be directly "intercepted" before the sensitive end devices.

# Surge protection concept

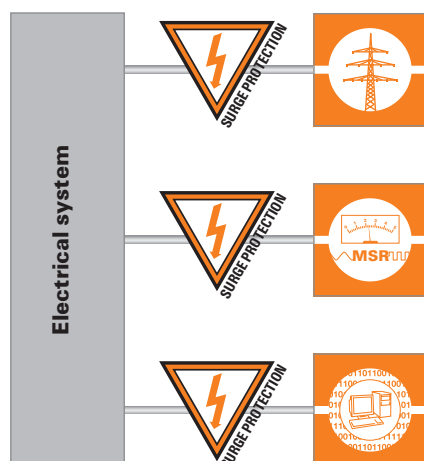

A fundamental requirement for effective surge protection is the presence of properly functioning equipotential bonding to DIN VDE 0100 part 540 in a series, or better still, star or grid arrangement.

DIN VDE 0110 (insulation coordination) divides overvoltage protection for power supplies and power distribution into the following three areas:

## 1. Power supply

The surge voltage strength of the insulation is 6 kV from the incoming supply to the building – by means of underground cables or overhead lines – right up to the main distribution board (backup fuse and meter cupboard). Owing to the lightning protection zoning concept and the physical circumstances, high-energy overvoltages have to be discharged here.

## Fundamental concept of protection

One important aspect of surge protection is the area of power supply and distribution. The procedure is linked to the systematic subdivision prescribed by the protective zones concept and the corresponding coordination of surge arresters. Protection of power supply lines forms the basis for protecting all electrical and electronic equipment right down to the smallest and most sensitive components.



Surge currents exceeding 200 kA can be generated by cloud-to-ground but also cloud-to-cloud lightning discharges.

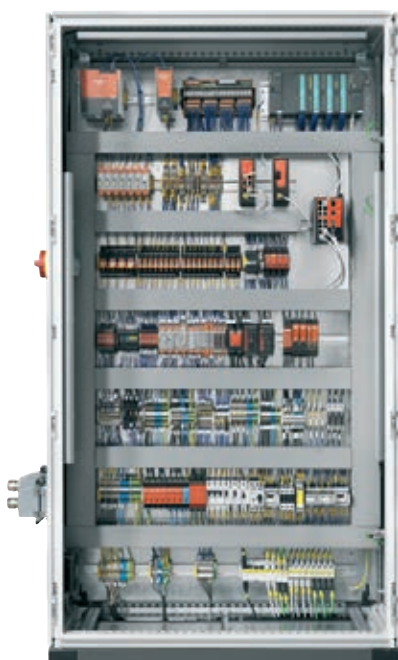

As a rule, 50 % of the current is discharged via the lightning protection system and the remaining 50 % is coupled into the conductors and conductive parts in the building and distributed uniformly. The closer a conductor is to the lightning protection system, the greater is the launched voltage (which can exceed 100 kV). The pulse duration can be up to 0.5 ms. These powerful interference pulses are discharged to earth directly at the incoming supply or main distribution board by Type I lightning arresters and limited to voltages below 6 kV. Power follow currents and backup fuse values are just some of the aspects that need to be taken into account here.

Depending on the local circumstances and the discharge currents to be expected, sparkover gaps or varistor surge arresters are used, taking into account the type of network.

## Surge protection concept

If a lightning protection system has been installed, or the power supply is via overhead lines, or buildings or plants are spread over a wide area and individual buildings are sited on elevated ground or open areas, high-capacity Type I arresters should always be employed.

### 2. Subdistribution

The surge voltage strength of the insulation is 4 kV from the main distribution board up to and including subdistribution boards. Owing to the co-ordinated use of arresters, Type II surge arresters are used here and, if necessary, decoupled from Type I arresters by means of coils. The use of decoupling coils is only necessary when the Type I arresters consist of one sparkover gap and the length of the line between the Type I and Type II arresters is less than 10 m. It is not necessary to decouple Weidmüller Type I and Type II arresters. The pulse currents that occur here are no longer that high because most of the energy has already been absorbed by the Type I arresters. Nevertheless, the line impedances give rise to high interference voltages which must be limited to less than 4 kV by the Type II arresters.

Type II arresters based on varistors are normally installed in the subdistribution board before the residual-current circuit-breakers.

### 3. Terminals, consumers, sockets

The surge voltage strength of the insulation is 2.5 kV from the subdistribution board to the electrical consumer. Surge arresters in Type III are used for this purpose. Depending on the application, they can be used as protective components or in composite switching together with gas discharge tubes, varistors, suppressor diodes and decoupling elements. These arresters are best installed directly before the device to be protected. This can be in a socket or trailing socket (on extension lead) but also in the terminal or junction box of the device itself.

To protect against permanent interference such as "ripples" or "noise" caused by other systems, additional filter circuits are available for the voltage supplies to devices. The insulation of the electrical consumer itself has a surge voltage strength of 1.5 kV.

### Principle for selecting arresters according to IEC 664 DIN VDE 0110 part 1

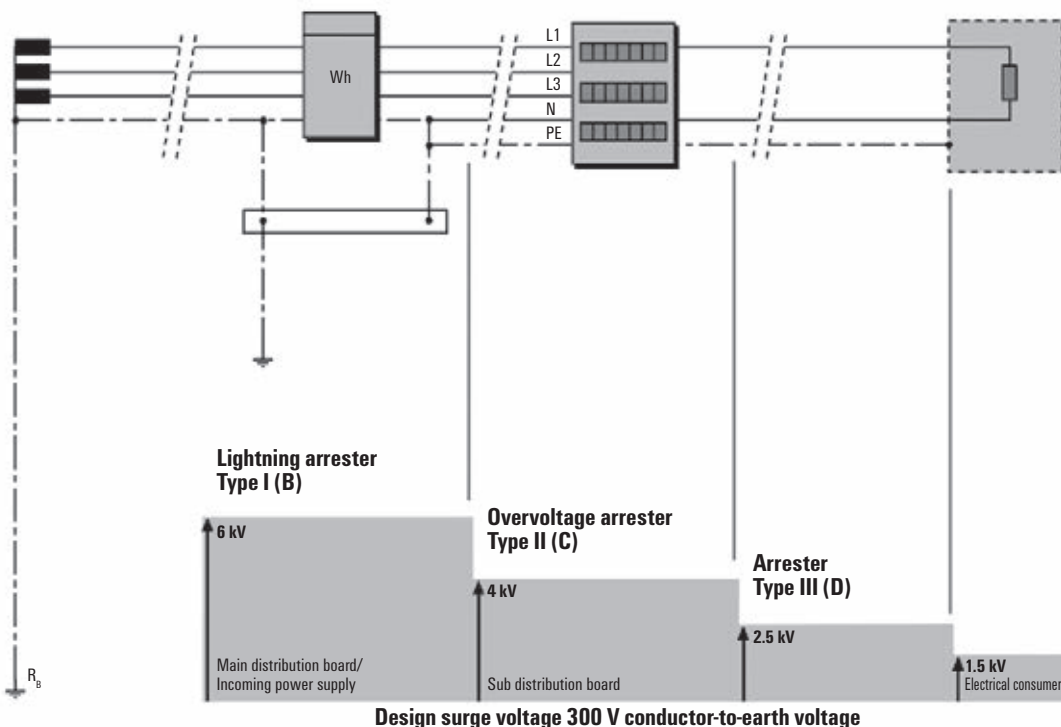

# Classification and protective zones

The requirements placed on surge protection and the necessary tests for surge protection components are stipulated by national and international standards. A product can only be considered safe after the product has been fully tested.

**For rated voltages up to 1000 V AC, the standards are valid for the manufacturers of surge protection devices and the installers of the surge protection within the facility or system. This catalogue contains a list of valid standards for your reference.**

The insulation coordination for electrical equipment in low-voltage systems to IIV EN 60664-1 (IEC 60664-1) is critical for the design of a surge protection solution. This specifies different dielectric strengths within electrical systems. Based on this, individual lightning protection zones can be set up according to IEC/EN 62305-3.

## Lightning protection zones

A protective zone is characterised by a fully earthed envelope. In other words, it has an enclosing shield which enables full equipotential bonding. This shielding can be formed by building materials such as metal facades or metal reinforcements. Lines that pass through this shield must be protected with arresters in such a way that a prescribed protection level is achieved. Further protective zones can be set up inside such a protective zone. The protection level of these zones can be lower than that of the enclosing protective zone.

This leads to a co-ordinated protection level for the objects to be protected. Not every individual section has to be protected with the maximum protection level (e.g. against lightning). Instead, the individual protective zones guarantee that a certain overvoltage level is not exceeded and hence cannot infiltrate that zone.

This leads to economic protection concepts with respect to the capital outlay for protective components.

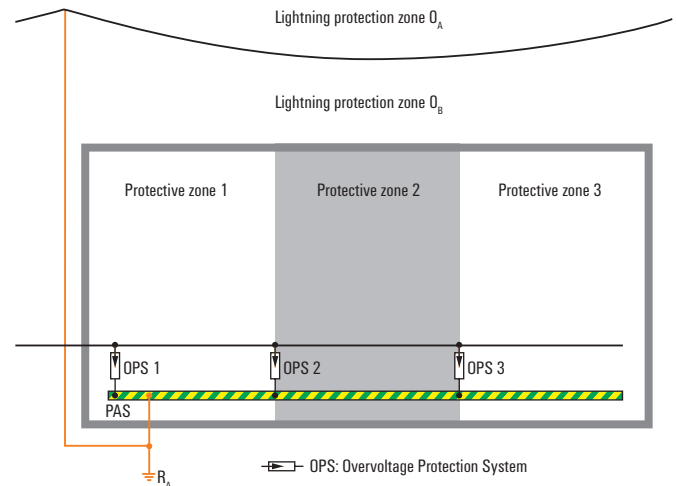

## Classification

Originally, protective zones were classified according to coarse, medium and fine protection. These protective zones were designated classes B, C and D in IEC 60099 (VDE 0675-1). There was also a class A for external arresters (e.g. for low-voltage overhead lines); however, this class has now been abolished. IEC 61643-11 classifies the protective zones as Types I, II and III.

**Comparison of surge protection classifications. Many national standards, e.g. in Austria, are derived from the aforementioned VDE or IEC standards.**

Formerly DIN VDE 0675 Part 6 / A1	New IEC 61643-11
Arresters of requirements class B, lightning protection equipotential bonding to DIN VDE 0185 part 1 ("B arresters")	"Type I" arresters
Arresters of requirements class C, surge protection in permanent installations, surge withstand voltage category (surge cat.) III ("C arresters")	"Type II" arresters
Arresters of requirements class D, surge protection in mobile/permanent installations, surge withstand voltage category (surge cat.) II ("D arresters")	"Type III" arresters

At Weidmüller, we make sure that all our surge protection products are tested by an independent testing lab for compliance with the relevant product standards. This is documented by test reports and corresponding test certificates.

## Lightning protection levels

## Lightning protection levels (LPL)

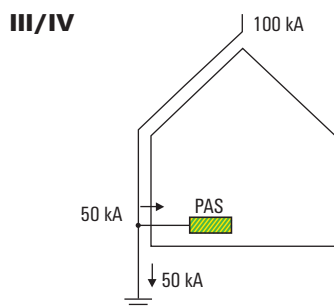
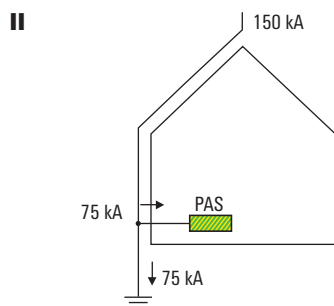
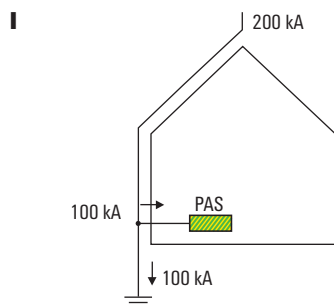

**The lightning protection level applies only to the pulse current 10/350 or to Type I.**

**Lightning protection level I**

Lightning protection level I covers a pulse of 200 kA. This is the worst-case scenario of a direct strike. This pertains to external lightning protection facilities.

Half of this pulse is conducted to the earth and the other half is conducted to the section of the facility that is conductive. If only a four-wire system is available, then a current of 25 kA is distributed to each wire. For a five-wire system, that would correspond to 20 kA.

This lightning protection class covers multiple areas, including: petrochemical facilities (Ex-zones) and explosive material depots.

**Lightning protection level II**

Lightning protection level II covers a pulse of 150 kA. This pertains to external lightning protection facilities. Half of this pulse is conducted to the earth and the other half is conducted to that section of the facility that is conductive. If only a four-wire system is available, then a current of 19 kA is distributed to each wire. For a five-wire system, that would correspond to 15 kA.

This lightning protection class covers multiple areas, including: parts of hospitals, shipping warehouses with fire alarm systems and telecommunication towers.

**Lightning protection level III/IV**

Lightning protection level III covers a pulse of 100 kA. This pertains to external lightning protection facilities. Half of this pulse is conducted to the earth and the other half is conducted to that section of the facility that is conductive. If only a four-wire system is available, then a current of 12.5 kA is distributed to each wire. For a five-wire system, that calculates to 10 kA. The 12.5 kA value is also used here. About 80 % of all applications are covered by lightning protection Type III. This includes houses, homes, administrative buildings and industrial facilities.



**Table 2.2.1**  
**Buildings requiring lightning protection, lightning protection levels, control intervals**

Building, facility, zone, areas	Lightning protection level	Control intervals (years)
<p>a Buildings that have rooms with a large number of occupants (e.g. theatres, concert halls, dance halls, cinemas, multi-purpose sporting/exhibition arenas, retail stores, restaurants, churches, schools, transportation facilities such as railway stations and similar sites of public assembly, including the associated buildings, which can be adversely affected by a lightning strike);</p> <p><b>Note</b>  Especially multi-purpose sports/exhibition arenas, theatres, cinemas, restaurants and similar sites with rooms where there could be 100 or more persons; sales sites with a total sales area of less than 1,200 m<sup>2</sup>, if the calculated number exceeds 100 persons, sales sites with a total sales area of more than 1,200 m<sup>2</sup>.</p>	II	10
<p>b Accommodation facilities (e.g. hotels, nursing homes, institutions, hospitals, prisons, military barracks);</p> <p><b>Note</b>  Especially hospitals, nursing homes where there are permanently or temporarily 10 or more persons who depend on outside help; especially hotels, inns and boarding houses where there are permanently or temporarily 15 or more persons that do not depend on outside help.</p>	II	10
<p>c Particularly tall buildings, including the adjoining buildings of normal height; high-rise buildings used as residential and commercial buildings, high chimneys and towers (church steeples).</p> <p><b>Note</b>  Buildings which are considered tall according to building legislation or where the top floor is more than 22 metres above the surrounding terrain serviced by firemen or where the eaves have a height of more than 25 metres.</p>	III II	10 10
d Buildings made from combustible materials with a total volume of more than 3,000 m <sup>3</sup> ;	III	10
e Large agricultural and operational buildings (more than 3,000 m <sup>3</sup> ) including the adjoining silos and adjacent residential buildings which could be adversely affected by a lightning strike; fermenting facilities or biogas plants;	III	10
f Industrial and commercial buildings in high-risk areas (such as plants and equipment where flammable or explosive materials are handled or stored), wood processing factories, mills, chemical plants, textile and plastics factories, explosives and ammunition depots, pipelines, gas stations;	II - I	10 - 3
<ul style="list-style-type: none"> <li>- Areas at risk of fire</li> <li>- Explosion-risk zones under a roof</li> </ul>	II I	10 3
g Containers for flammable or explosive substances (such as flammable liquids or gases), warehouses for solid or liquid fuels and associated buildings and facilities (e.g. machine buildings, gas stations, storage buildings with filling equipment);		
h Buildings and facilities which house content with special value items (e.g. archives, museums, collections);	II	10
i Buildings and facilities which house sensitive technical equipment (e.g. IT and telecommunications facilities); Data centres;	II	10
j Buildings and installations in exposed topographic positions (e.g. free-standing building [alpine huts] in the mountains	III - I	10 - 3

Extract from the guidelines of the SEV 4022 Lightning Protection Systems 2008; please follow the installation regulations and standards in the individual countries.

W



## Network forms to DIN VDE 0100 part 300 (DIN 57100 part 310)

The letters in this table describe the earthing conditions:

1st letter Earthing at current source	2nd letter Earthing of exposed conductive parts of electrical installation	3rd letter Routing of N and PE conductor (only applies to TN systems)
<b>T-</b> Direct earthing of current source (of transformer)	<b>T-</b> Exposed conductive parts of electrical installation are earthed directly	<b>C-</b> "Combined" N conductor and PE conductor are routed together as PEN conductor from current source into electrical installation
<b>I-</b> Insulated structure of current source	<b>N-</b> Exposed conductive parts of electrical installation are connected to earth of current source	<b>S-</b> "Separate" N conductor and PE conductor are routed separately from current source to exposed conductive parts of electrical installation

### Four-conductor systems:

Still valid according to VDE but unfavourable for information technology systems from the point of view of EMC (VDE 0100 pt 444 / pt 540 pt 2).

### TN-C systems ("classic earthing")

Neutral conductor and protective earth conductor functions are combined throughout the network in a single conductor, the PEN conductor.

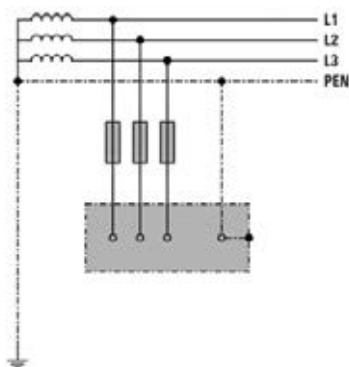

### TN-C-S systems ("modern earthing")

Neutral conductor, PEN conductor and equipotential bonding system are connected once at the main distribution board or after the incoming supply to the building. Therefore, a TN-C system becomes a TN-S system (TN-C-S system) from this point onwards.

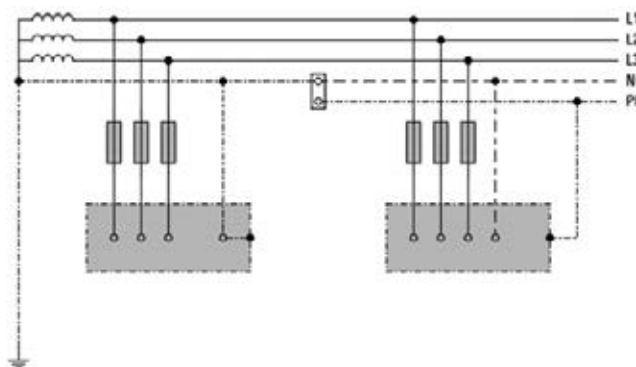

**Five-conductor systems:**

The neutral point of the supply source is earthed (N and PE). Both conductors must be laid separately and insulated from the incoming supply onwards. In these systems the PE (protective earth conductor) does not carry any operating current but instead only discharge currents.

**TN-S systems**

Neutral conductor and protective earth conductor are separated throughout the network.

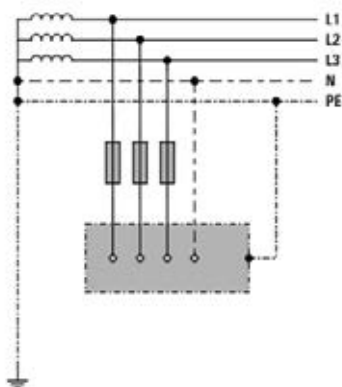
**TT systems**

One point is earthed directly (operational earth). The exposed conductive parts of the electrical installation are connected to earth lines separate from the operational earth.

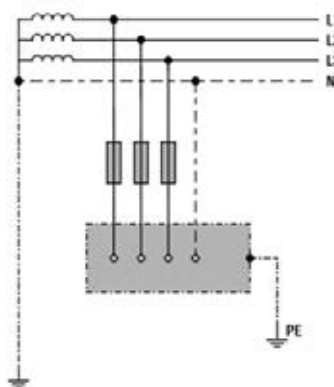
**Special system:**

Used, for example, in medical applications

**IT systems**

There is no direct connection between active conductors and earthed parts. The exposed conductive parts of the electrical installation are earthed.

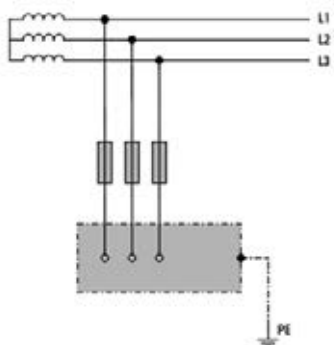

## Surge protection with 3+1 circuitry in consumer loads with TT power systems

3+1 does not always equal 4! At least not in the case of protective circuits with arresters in a TT system.

In a TT system the supply is via the three phase conductors L1, L2 and L3 and the neutral conductor N, i.e. without an additional integral PE conductor. The equipotential bonding is then made separately within the consumer installation through the earthing. The outcome of this is that the neutral conductor can accommodate a higher voltage compared to the earth potential. Therefore, to protect against overvoltages between neutral conductor and earth potential, an arrester must be incorporated here as well.

The "four-arrester circuit" does not satisfy all safety aspects. Up to now, four arresters, i.e. one each between earth potential and L1, L2, L3 and N, were installed in consumer installations with TT systems. However, this "four-arrester circuit" is no longer regarded as the optimum solution because the physical characteristics of the varistors used may lead to unacceptably high touch voltages at the PE conductor in the consumer installation. Depending on the age of the system, leakage currents can flow through varistors and cause overvoltages via the earthing resistance.

The downstream RCD-(Fi) circuit breaker found in TT systems cannot detect such leakage currents. Therefore it cannot trigger. Furthermore, a failed, i.e. low-resistance, varistor would create a connection between N and PE. One remedy is to install an arrester disconnecter in sequence with the varistors. But an arrester disconnecter that monitors the varistors takes up space and costs extra.

If instead of varistors, sparkover gaps were to be arranged between the conductors and the equipotential bonding, then that, too, would not be an ideal solution. The longer time to sparkover and the characteristics of the sparkover gaps result in higher residual voltages.

The 3+1 circuit includes varistors with the three L conductors and the N conductor, and a sparkover gap between the base of the three varistors at the N conductor and the equipotential bonding rail (PE). The size of the sparkover gap must be such that it can accommodate the total current of the three phase conductors and the neutral conductor. The sparkover voltage of the sparkover gap in 230 V systems should be 1.5...2 kV.

### TN-S system

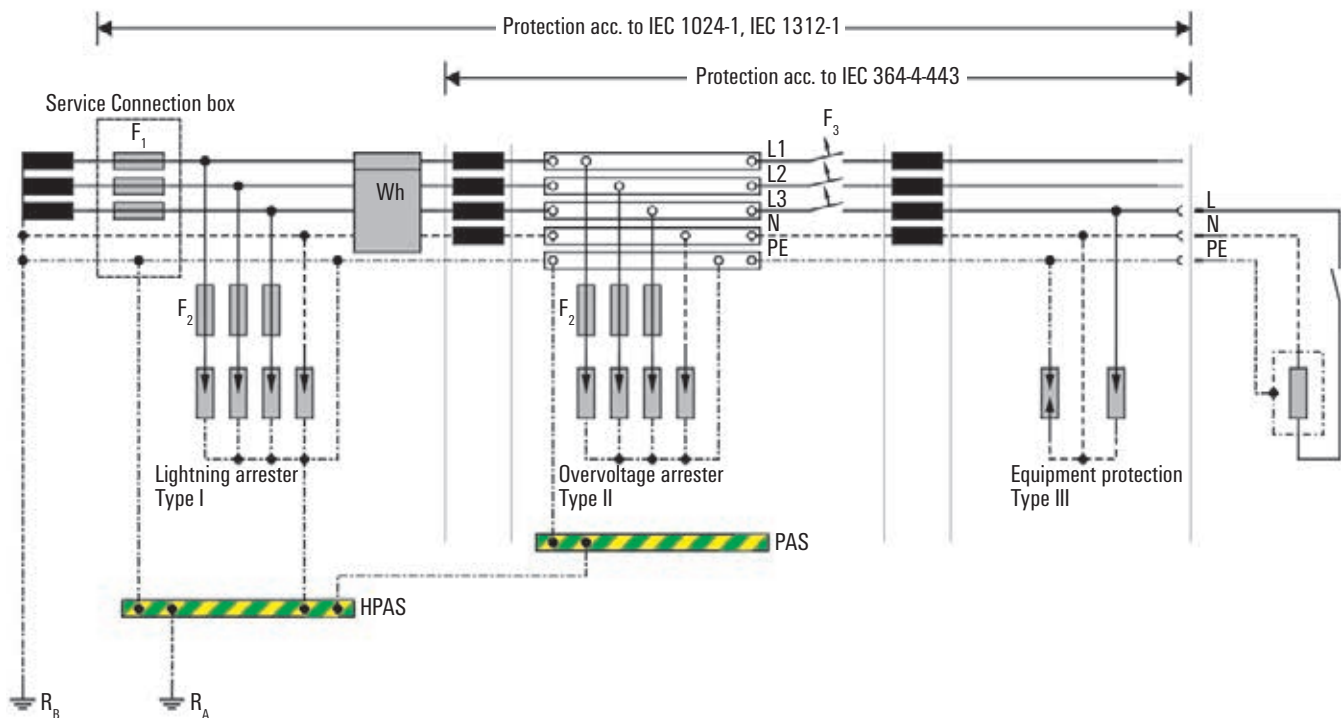

The sparkover gap isolates the three varistors electrically from the PE so that leakage currents through the varistors cannot cause voltage increases at the PE. The residual-current circuit-breaker behind the 3+1 circuit then provides reliable protection against hazardous touch voltages in all situations.

In terms of its relevance for safety aspects, the 3+1 circuit described in VDE 0100 part 534 (section 534.2.2) can therefore be regarded as a solution for surge protection in TT systems.

Note: Although the "four-arrester circuit", i.e. with one varistor each between earth potential and L1, L2, L3 and N, is prescribed in VDE 0100 part 534 (section 524.2.1) for consumer installations in TN-S systems, the 3+1 circuit would also be possible here without increasing the risk. In ÖVE/ÖNORM E 8001-1/A2:2003-11-01, the 3+1 circuit is already expressly listed for use in TN-S and TT systems.

## TT system

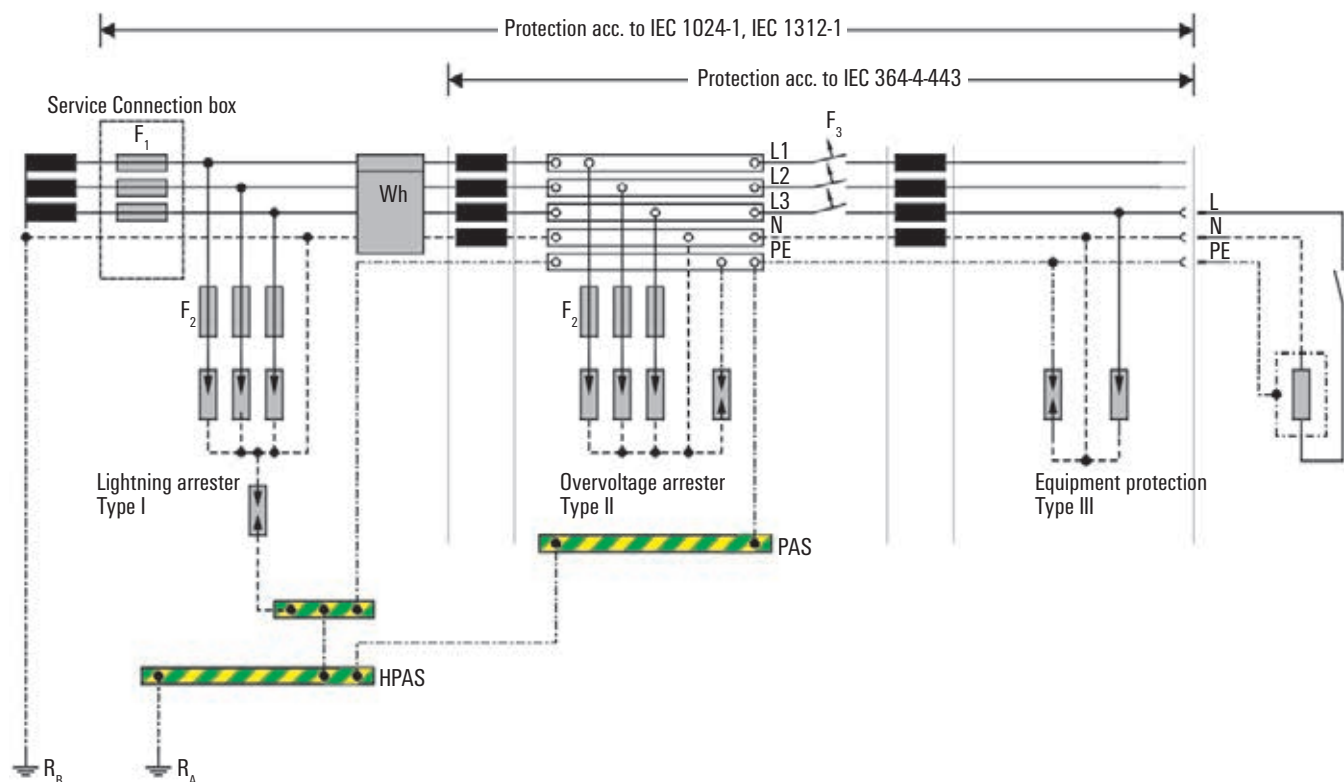

## General installation advice

Many details have to be taken into account during the installation of surge protection and the electrical system in order to achieve optimum protection.

### Arrangement and subdivision of electrical panel

Steel cabinets possess good magnetic shielding properties. The following points should be taken into consideration during the installation:

- Avoid unnecessarily long lines (particularly lines with a high volume of data traffic).
- Route sensitive signalling lines separately from lines with a high interference potential.
- Route shielded lines directly to the equipment and connect the shielding there (do not connect via additional terminal in switching cabinet).
- Classify equipment in groups with different sensitivities and place these together.

### Place of installation

The surge protection devices should be mounted where the lines and cables enter the cabinet. This is the lowest mounting rail directly above the cable entries. This prevents interference being coupled within the cabinet; interference is discharged right at the entry to the cabinet. When using shielded lines, these can be connected at this point by using Weidmüller clamp straps.

### Routing the lines

Signalling lines should be laid within the system/cabinet over the shortest route to the surge protection and then continue to the connected equipment. Protected and unprotected lines should be routed separately. The earth line should be regarded as an unprotected line. Metal partitions can be used along cable routes or in cable ducts to achieve this separation. If signalling lines are laid parallel to power lines, a clearance of min. 500 mm must be maintained. The best shielding offers metallic cable conduits along with a metal cover.

### Earthing of products and connected products

All surge protection devices have an earth-connection terminal point. The earthing wire for the associated equipotential bonding rail must be connected to this point. The earthing wire should have as large a cross-section as possible and also be as short as possible. Every centimetre of extra cable length increases the residual voltage of the surge protection device (1 metre / 39 inch of cable = 1 kV voltage drop). In addition to the earthing terminal, the surge protection products for measurement control systems also offer the option of earthing via a DIN rail contact on a TS 35. In order to achieve the best earth contact, the rail should be mounted to an earthed metal back wall. In order to obtain a lower protection level, the earthing terminal on the surge protection products (for measurement and control systems) should be connected to the equipotential bonding every 60 cm / 24 inch. According to IEC 62305, the PE connection and the SPD spur may only be 0.5 m / 20 inch to the lightning protection equipotential bonding. It is possible to make the path as short as possible by using a so-called V-connection or by connecting to the accompanying PE.

### Cable lengths

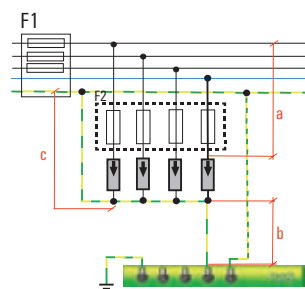

**It is valid:**  
 $a + c \leq 0.5 \text{ m} / 20 \text{ inch}$   
 $a + c \leq 0.5 \text{ m} / 20 \text{ inch}$ ,  
 then b is not relevant

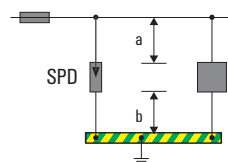

$a + b \leq 0.5 \text{ m} / 20 \text{ inch}$

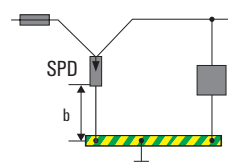

$b \leq 0.5 \text{ m} / 20 \text{ inch}$

W



### Fuse protection

Surge protection devices for instrumentation and control systems frequently operate with a decoupling between the components. This decoupling is carried out using inductors or resistors. The decoupling dictates the cable type, cable routing and also a fusing for the maximum nominal current of the surge protection devices. The fusing for the VPU series on the power supply side must be installed in accordance with DIN VDE 0298 part 4 (cross section, quantity, type of conductor and the type of installation). This information is documented in the package insert and on the products for the corresponding VPU modules. In the event of overloads caused by partial lightning currents or transformer short circuits, the lightning arrester and surge arrester (SPD) must be protected by a back-up fuse if F1 is greater than the value specified by the manufacturer. In compliance with the ratio 1:1.6, the maximum nominal value should be configured for the SPD. Depending on the installation of the connecting cables, F1 can be increased during the lifespan of the facility. If a circuit breaker or a main circuit breaker is used instead of the safety fuse required in the installation instructions, then the triggering characteristics must be followed.

### Lightning current strength of NH fuses for surge currents 10/350 $\mu$ s

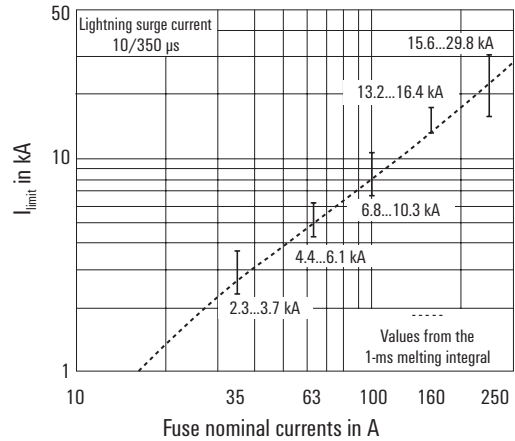

### Lightning current strength of NH fuses for surge currents 8/20 $\mu$ s

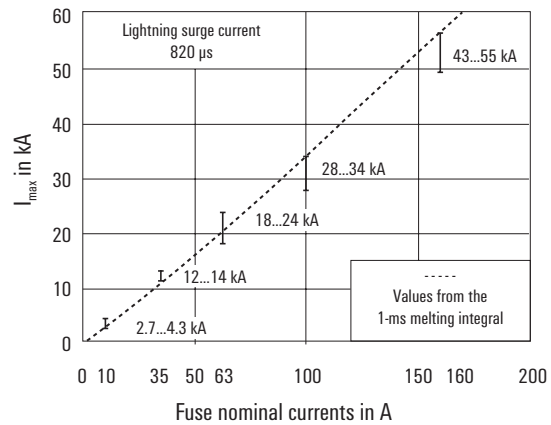

General installation advice

**Behaviour of NH fuses for lightning surge current (10/350  $\mu$ s)**

It is important to understand that the question is not how small the SPD fusing should be; rather the maximum back-up fuse that should be used, as the capacity of the small fuses to carry lightning current is very limited. Unrestricted SPD protection is only available when the installation accommodates the maximum value.

Nominal current and design

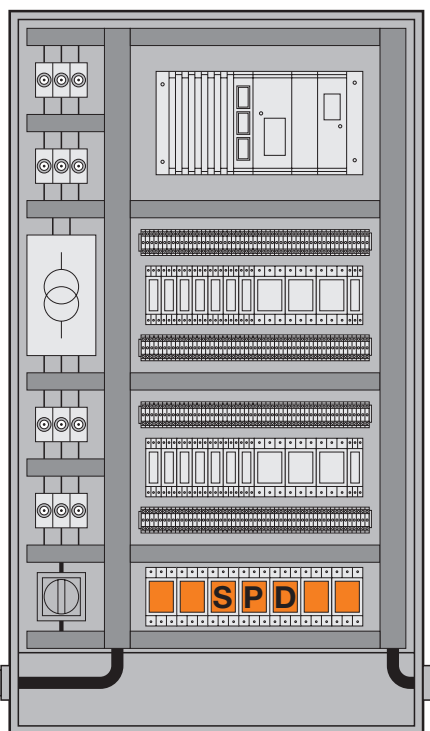
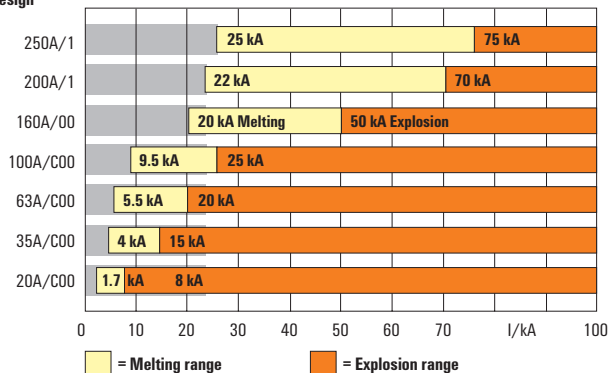

Installation site of the lightning and surge protection products

W



# Installation instructions for Weidmüller's VPU I, VPU-II and VPU-III lightning/surge protection in power grids

Surge protection should only be installed by trained personnel. Please follow all local regulations concerning connection methods during the installation.



## 1 Application

Type I VPU I lightning protection and the Type II VPU II surge protection are used to protect low-voltage consumer installations and electronic devices against surge voltages that may arise as a result of atmospheric discharges (thunderstorms) or switching operations.

The VPU I is a Type I/II lightning arrester according to IEC 61643-11, ENV 61024-1 and IEC 1312-1. In the event of a lightning strike, the required equipotential bonding (lightning protection equipotential bonding according to IEC 62305 part 1) between the building lightning protection and the earthing system for the power supply is provided by built-in varistors.

The VPU II complies with Type II of IEC 61643-11 and ÖVE SN60 part 4 and part 1. Metal-oxide varistors are used as voltage-limiting components. The VPU III and VPO-DS Type III surge protection for end devices protect low-voltage consumer installations and electronic devices against surges and switching operations. The VPU III or VPO DS is installed in addition to the VPU II in the small distributor, floor distributor, cable conduit, or directly behind the outlet. They meet the requirements of IEC 61643-11 and EN 61643-11.

## 2 Installation location

The VPU II needs to be installed in the meter cabinet or in the distributor so that the space for connection terminals is not accessible to unauthorised persons. The VPU I is installed near the power feed so that there is the required lightning current equipotential bonding between the lightning protection facility and the power distribution system. All arresters must be installed by a qualified electrician.

The VPU I LCF can be installed upstream of the meter. VDE 0100 part 534 "Selection and installation of equipment" describes the construction of facilities with surge protection equipment.

This is related to the following standards:

**a. IEC 60364-4-43:**

"Protection for surge voltages from atmospheric origins and from switching operations"

**b. IEC 60364-5-53:**

"Selection and installation of electrical equipment"

**c. IEC 61024-1:**

"Protection of buildings against lightning strikes"

**d. IEC 61312-1:**

"Protection against lightning electromagnetic pulses"

## 3 Electrical connection

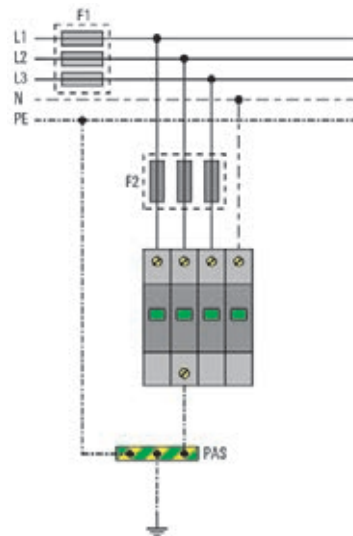

The shortest possible cables should be used to connect the VPU I lightning arrester and the VPU II surge protector with the phase conductors (L1, L2, L3) or the neutral wire (N) and the earth (PE) on the consumer installation. Unprotected cables should never run in parallel with protected cables (connection examples can be found on the last page).

### 3.1 Connection to the phase conductor and the neutral wire

When connecting cables to the VPU I/VPU II arresters, normally the same wire cross-section is used both for the phase conductors (L1, L2, L3) and the neutral wire (N). If you need to reduce the cross-sections, then a protective device (e.g. a main port fuse) should be used to protect the connecting cables from short circuits. The terminals of the arrester must not be used as branch terminals. The back-up fuse for the VPU II can be up to 200 A gL. For the VPU I, a max. of 315 A gL can be selected for the back-up fuse.

#### Notes:

In the TN-CS power grid, 3-pole VPU IIs are used (on the TN-C side). If the PEN conductor uses a separate PE and N, then a 4-pole VPU II should be used (on the TN-S side). According to DIN VDE 0100-534/A1 10/96, a VPU II 3+1-280 V protector can be installed in a TT-type power grid. For an IT grid with a 400 V phase-wire voltage, the VPU II 3+1 385 V should be installed for 385 V.

### 3.2 Connection to the earth

The earthing wire of the arrester is connected via the shortest path to the earthing system of the consumer installation. Longer connecting cables reduce the effectiveness of the surge protection. They should not be routed in parallel to other cables. An equipotential bonding rail is available as a connection point in electrical consumer systems with equipotential bonding. You must be certain that the earthing for the arrester is connected to the earthing system of the consumer installation.

In TN power grids, the PEN conductor and the earthing line of the arrester should be connected to each other. The PEN conductor from the electrical utility may not be used as the earth.

If the PE or PEN rail on a distributor is used as the earthing terminal, then the rail must be connected via a separate earth wire to the earthing system of the consumer installation.

Two ground terminals are provided in the VPU I. Both terminal points must be connected. One leads to the equipotential bonding connection on the building and the other leads to the PE conductor on the installation. For Type I lightning arresters, a conductor for carrying lightning current must be used that is at least 16 mm<sup>2</sup>. A minimum cross-section of 4 mm<sup>2</sup> is required with Type II surge protection.

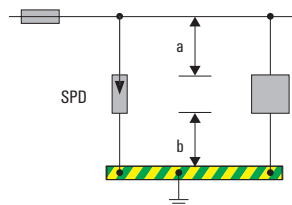

$$a + b \leq 0.50 \text{ m}$$

### 4 Installation of surge protection for end devices (Type III arresters)

The VPU III or VPO-DS arrester is installed together with and after the VPU II. The VPU III or VPO DS is built into the cable that is to be protected. It can then protect a circuit up to 16 A. The VPU III can be installed in small distribution boards for one circuit (e.g. for protecting monitors). The VPO DS can be installed in devices or in cable conduits on-site.

- D** Vor Isolationsmessung trennen oder Schutzelement ziehen!
- EN** Before conducting isolation measurement, remove plug-in protective elements!
- I** Prima di misurare l'isolamento scollegare il sezionatore o i fusibili di protezione!
- FR** Avant toute mesure d'isolation déconnectez les éléments de protection ou de séparation.
- E** Antes de realizar la medición de aislamiento, retirar el descargador.
- GM** 在做绝缘测试前,请先断开保护回路或拔下保护模块!

13832 10000/06/2012

Weidmüller

### 5 Functional check

It is important to visually inspect VPU lightning arresters and surge protectors, especially during stormy weather. If the colour of the viewing window changes or if the LED is red, then the SPD must be replaced. As the varistors get older, the temperature of the varistors may increase. In low-voltage networks this can lead to fire. Therefore all SPDs have a built-in temperature monitoring mechanism that isolates the varistor automatically from the power supply in the event of danger. A signal or LED indicates that it has been switched off. An additional switching contact (remote signalling contact) reports this separation (this is labelled with R in all product designations). The functionality of all VPU modules can be tested using testing equipment (such as the V-TEST), which is available separately.

## 5.1 Replacements

When an arrester has a red window (as described by point 5) or a red LED, then the arrester should be replaced by a qualified electrician. The individual Type I-II arresters are pluggable and coded for voltage.

For the insulation resistance test, the SPD must be disconnected from the facility during the duration of the measurement (e.g. by pulling out the upper sections) or the arresters are disconnected from the power network. Weidmüller provides special notice stickers for the electrical cabinet (order number 1287670000) for this purpose. A proper arrester that matches the nominal voltage must be re-installed.

## 6 Connecting the remote signalling (R)

The signal contact is designed as a change-over (CO) contact. It is connected to terminals 11 and 14. Terminals 11/12 are in normal operation (window is green) closed and terminals 11/14 are open. In the event of an error (red box), the connecting terminals 11/14 are closed and 11/12 are open.

For the VPU III, the response of the isolating mechanism is signalled when a non-reversible thermal fuse opens.

The alert circuit is connected using cables with a maximum cross-section of 1.5 mm<sup>2</sup>. The connecting cables must not be run parallel to the earthing cable. A protective circuit using fine surge protection (Type III) according to the voltage level can reduce interference on and in the evaluation device.

## 7 Back-up fuse

The lightning and surge protection devices in the VPU I and VPU II series behave passively during normal operation. No current is drawn. This provides the necessary protection against short circuits and overloads by using a fuse that is designed for the installation method and the cross-section of the connected cable. The VPU product series is also tested with a maximum back-up fuse. This back-up fuse is listed in the technical specifications or the side label on the product. If the fuse used in the system has a smaller or equal value, then it can be used for cable protection on the power feed. If the power-feed fuse has a value greater than the fuse specified in the technical specifications, additional fuses must be integrated depending on the connecting cable in the wiring harness of the VPU module. Remember that the fuse for the wiring harness is also capable of carrying a lightning current. This fuse should not be too small which would make the SPD ineffective during an actual power surge.

## 8 Application

The VPU I LCF and VPU I establish the required lightning protection equipotential bonding for existing lightning protection systems and power feeds. The encapsulated VPU I LCF and VPU I are preferably used in the distributors in building installations. The blow-out PU I TSG is often installed for industrial applications (such as wind power facilities) with voltages of 330 V or 440 V. The VPU I LCF and VPU I TSG+ products can be used before the meter, since this does not cause leakage current during operation. The VPU I LCF and the VPU I have been certified as lightning protection as well as surge protection. This means that they are permitted for Type I and Type II (whereby the VPU II surge protector is permitted for Type II and III) – surge protection and end-device surge protection. VPU III and VPO DS are Type III surge protectors for end devices.

## 9 Approvals

The VPU I and VPU-II series have a CB report and can thus be rewritten for country-specific approvals. All products bear the CE mark.

## 10 A brief overview of the installation standard for lightning and surge protection

Based on VDE 0100-534, derived from the IEC 60364-5-53 standard. This standard specifies the surge protection (Type I or II) that should be installed.

The IEC 60364-5-534 standard may not be the same as the adopted standards from each country. The country-specific standards and application-based standards or rules must be observed during the installation. The installation must be carried out by locally licensed professionals.

The VDE 0100-534 distinguishes between the connection diagrams **A**, **B** and **C**.

The following is derived in actual practice:

**A** = 3+0 circuitry (VPU I 3 or VPU II 3 in the TN-C system)

**B** = 4+0 circuitry (VPU I 4 or VPU II 4 in the TN-S system)

**C** = 3+1 circuitry (VPU I 3 +1 or VPU II 3+1 in the PU II TN-S/TT or IT system with N).

## Surge protection installation instructions

VDE 0100-534 now states that there should be a gap of  $\leq 0.5$  m between the SPD in the vicinity of the installation location and the direct connection to N or PE.

IEC 60364-5-534 specifies that the earth must be established from the SPD to the equipotential bonding rail or to PE – whichever is the shortest connection.

Both cables are specified in the VDE.

During the insulation test, the SPD must be isolated from the facility for the duration of the measurement.

Establishing SPDs after an RCD is only permitted under special preconditions.

### Protection against surge currents

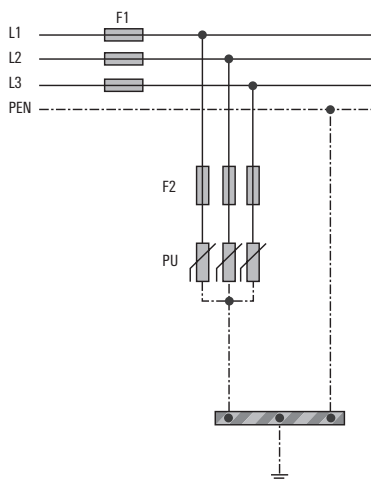

The F2 fuse ensures protection against SPD short circuits. These fuses should be chosen based on the rated currents listed in the installation instructions from the SPD manufacturer. The F2 fuse does not need to be used when the characteristics of the F1 fuse (which is part of the electrical facility) correspond to a combination of the rated currents specified by the SPD manufacturer.

# Standard texts for surge protection tenders

You will find standard, up-to-date texts for tender documents at our Internet site [www.weidmueller.com](http://www.weidmueller.com) – select language: English. These will help you draw up the specification to suit your installation.

The advantage of this is that you can download the correct, up-to-date technical information from our Internet site at any time



**Weidmüller**

Select Country

**Product Catalogue** Home Corporate Industries Products Career Press Downloads

Print Media  
Software  
Printer Driver  
CAE Data  
**Information for Tenders**  
Certificates & Approvals  
Download feed  
Movies

Home » Downloads » Information for Tenders

## Information for Tenders

Data and descriptions of Weidmüller products as GAEB files or as Word document for Invitation of Tenders

Currently we can offer you data on several products for Surge Protection.

Surge Protection (GAEB)	
MSR	<a href="#">Download</a>
QVP data interfaces	<a href="#">Download</a>
QVP Siter	<a href="#">Download</a>
PU	<a href="#">Download</a>

Surge Protection (.doc)	
Data systems	<a href="#">Download</a>
MSR signals, DK series	<a href="#">Download</a>
MGR signals, MGZ series	<a href="#">Download</a>
PU	<a href="#">Download</a>

Share with your network: [Facebook](#) [Twitter](#) | subscribe to our news: [RSS Feed](#) [Print Page](#)

Copyright Weidmüller Interface GmbH & Co. KG | Klingenbergstraße 16 | D-52750 Detmold



Please visit our online catalogue on our homepage for more product information.  
[www.weidmueller.com](http://www.weidmueller.com)

# Applications, installation positions: Application Office building

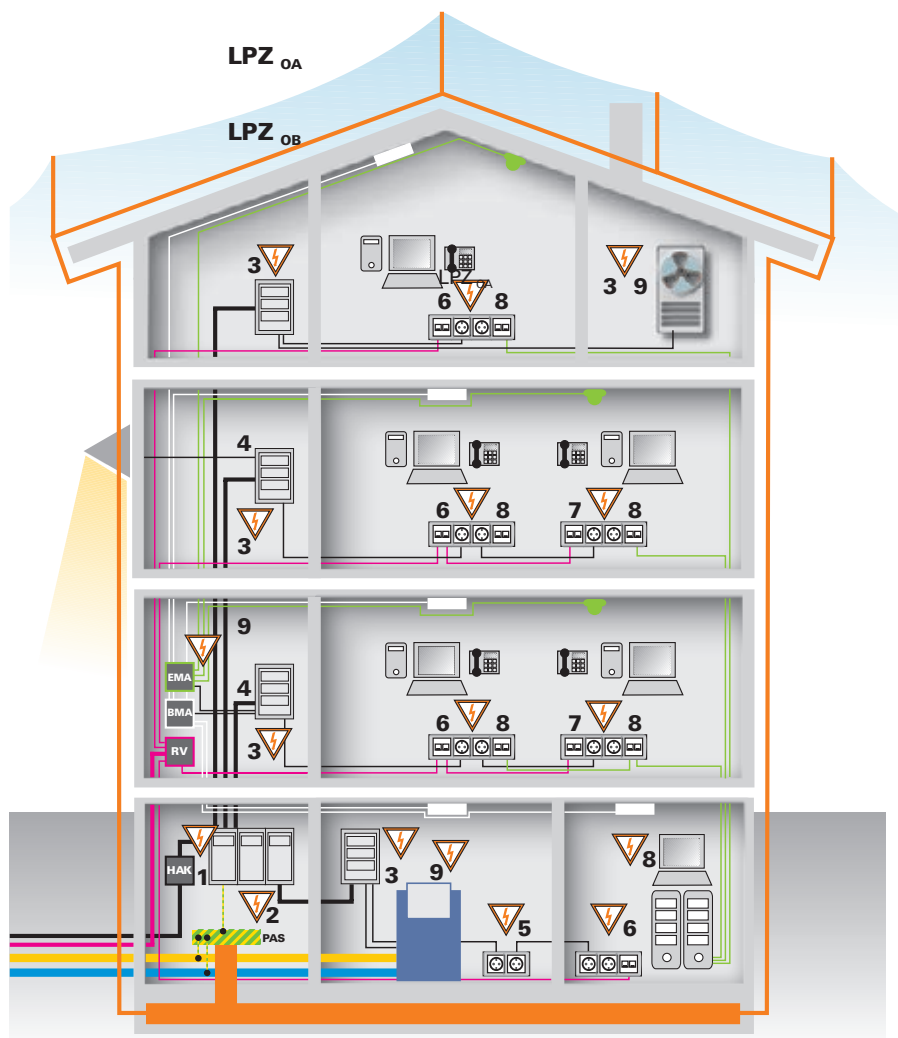

## Power (low-voltage supply)

- 1 Type I Arresters with sparkover gaps with/without high-power varistors, VPU I LCF
- 2 Type I Arresters with high-power varistors, VPU I series
- 3 Type II Arresters with high-power varistors, VPU II series
- 4 Type III Arresters for installing in subdistribution boards, VPU III series
- 5 Type III Arresters in the form of plug-in surge protectors, VPO DS

## Data

- 8 Surge protection for data lines, e.g. Ethernet CAT.5

## Power and data

- 6 Type III Arrester VSPC
- 7 Type III Arrester VSPC

## Instrumentation and control equipment

- 9 Surge protection for measurement and control circuits, e.g. VSPC or VSSC

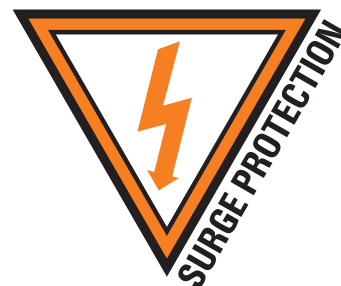

# Applications, installation positions:

## Application Industrial building

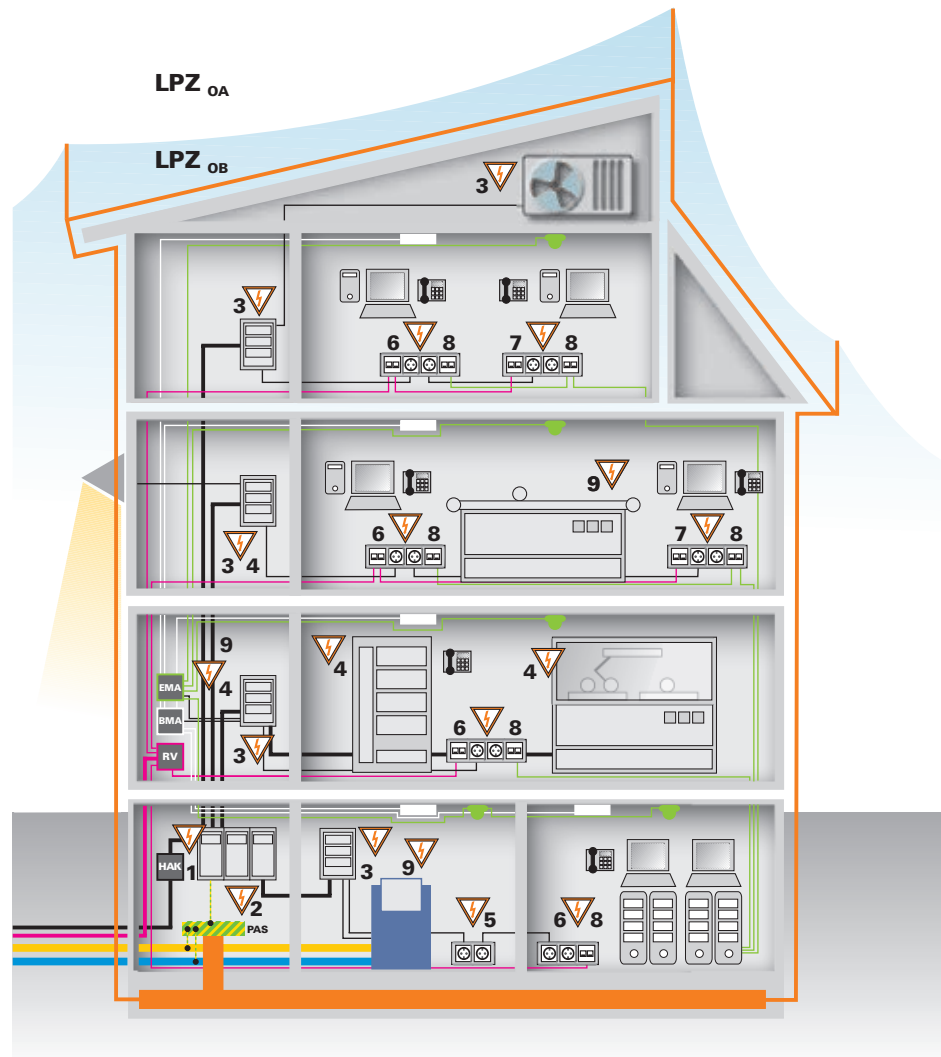

### Standards

**IEC 61643-11**, SPDs connected to low-voltage power distribution systems. Type I, Type II and Type III products are tested in accordance with this standard.

**IEC/EN 62305-1 until 4,-** Protection against lightning.

This lightning protection standard defines everything to do with internal and external lightning protection. It includes four sections:

- "Protection against Lightning – Part 1: General principles"
- "Protection against Lightning – Part 2: Risk management: assessing the damage risk for buildings and structures"
- "Protection against Lightning – Part 3: Physical damage to structures and life hazard"
- "Protection against Lightning – Part 4: Electrical and electronic systems within structures"

Regulations for installation

**IEC 60364-5-53**, Electrical installations of buildings – Part 5-53. (Content in VDE 0100-534). Standard for the installation of low-voltage facilities.

**VDE 0800**, **VDE 0843-T5**, **VDE 0845** describe the selection and installation for communication electronics.

Guidelines for the SEV lightning protection system SN 4022:2004 and the SEV 4113 foundation earth

**Current**

**Telecom**

**Gas**

**Water**

**LPZ<sub>OA</sub>**

Unprotected area outside of the building. Direct lightning strike; no shielding against electro-magnetic interference.

**LPZ<sub>OB</sub>**

Area protected by lightning protection system. No shielding against LEMP.

W



# Components for Surge protection

## Surge protection devices (SPDs)

There is no ideal component that can fulfil all the technical requirements of surge protection equally effectively. Instead, we use a variety of components with different physical methods of operation that complement each other; these possess distinct protective effects. Super-fast reaction time, high current-carrying capacity, low residual voltage and long service life cannot be found in one single component.

In practice we use three principal components:

1. spark gaps
2. varistors
3. suppression diodes

Therefore, to optimise the surge protection solution, carefully matched groups of these components are often combined in one protective module.

## 1. Spark gaps / GDT



Possible types:  
Blow-out spark gap  
Encapsulated spark gap  
Gas-filled spark gap

### Pulse form shape without GDT

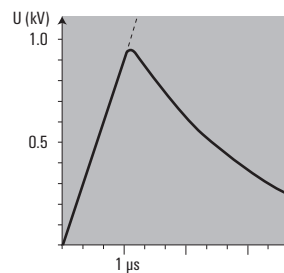

### Pulse form shape with GDT

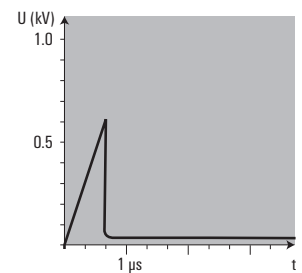

The name says it all. High voltages are discharged to earth via a spark gap (e.g. gas discharge tube) that has been fired. The discharge capacity of sparkover gaps is very high – up to 100 kA depending on type.

Gas sparkover gaps are incorporated in insulating glass or ceramic (aluminium oxide) housings. The electrodes of the sparkover gap are made from a special alloy and placed in housings which are vacuum sealed and filled with a noble gas such as argon or neon. They are aligned with respect to shape and clearance distance, so that the applied voltage produces a distribution of field strengths. This results in a fairly precise voltage value for the complete ignition of the spark gap. The housings are vacuum-tight and filled with an inert gas such as argon or neon. The spark gap has a bipolar function. The ignition voltage value, however, is dependent on the steepness of the applied surge voltage.

The ignition characteristic curve for gas-filled spark gaps reveals that the ignition voltages increase for those surge voltages which climb more steeply. The consequence is that, for very steep surge voltages, the ignition voltage (that is, the protection level) is relatively high and can be well in excess of the rated voltage for the spark gap (approx. 600–800 V). The problematic quenching behaviour of the fired sparkover gap can be a disadvantage. The arc has a very low voltage and is only extinguished when the value drops below this. Therefore, when designing the geometry of a sparkover gap, care is taken to ensure that – through long distances and also through cooling – the voltage of the arc remains as high as possible and so is quenched relatively quickly. Nevertheless, a longer follow current can ensue. This can draw its energy, in addition, from the incoming supply of the circuit to be protected. One effective solution is to wire a sparkover gap and a fast-acting fusible link in series.

## 2. Varistors / MOV

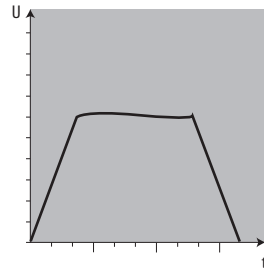
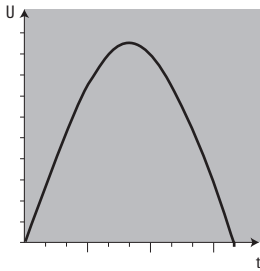

The varistors used with surge protection (MOV-Metal Oxide Varistors) have resistance which depends on the voltage. This is implemented with metal-oxide (zinc-oxide) discs. There is a low-ohm resistance in the range above the rated voltage. The surge voltage is limited since a current flows through the varistor. The varistor works bi-directionally. Depending on the type, varistors have either a middle or high discharging capacity. It is in the range from 40 kA to 80 kA. The response time is less than 25 ns. However there are also disadvantages when using varistors. Two factors that must be taken into account are the relatively high capacitance and the aging characteristics.

Leakage currents occur over time, depending on the frequency of the triggering, because individual resistance elements break down. This can cause temperature rise or even destroy them completely.

This is one reason for thermal fuses being built into Weidmüller products. The high capacity of the varistors is problematic for circuits with high frequencies. Some signal attenuation should be expected at frequencies above 100 kHz. We therefore recommend that they are not used in data transmission systems.

## 3. Suppression diodes / TAZ

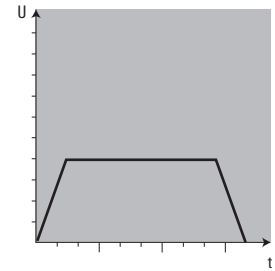
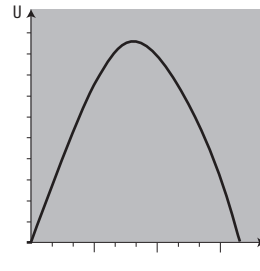

Suppressor diodes function in a similar fashion as Zener diodes. There are uni-directional and bi-directional versions. Uni-directional suppressor diodes are often used in DC circuits. Compared to standard Zener diodes, suppressor diodes have a higher current-carrying capacity and are significantly quicker. At a certain breakdown voltage level, they become conductive very quickly. They therefore discharge the surge voltage. However their current-carrying capacity is not very high. It is only a few hundred amps. Instead, they feature a very quick reaction time which lies in the picosecond range.

Unfortunately, suppression diodes possess a significant inherent capacitance. Therefore, like with varistors, their possible attenuation effect on high frequencies must be taken into account.

#### 4. Combination circuits

Combining the components described above results in surge protection products that can match individual requirements. If a voltage pulse reaches the input of such a combination circuit, then the gas discharge tube is fired and discharges high current. The residual pulse is attenuated by a downstream inductance and subsequently received and limited by the varistor and/or suppression diode. If the gas discharge tube is not triggered, i.e. in the case of a slower voltage rise, then the pulse is discharged by the varistor or the suppression diode alone.

The sequence of the individual components results in an increasing response sensitivity towards the output. An interference voltage with a rise of  $1 \text{ kV}/\mu\text{s}$  and a peak value of  $10 \text{ kV}$  at the input is limited by a gas-filled surge arrester to approx.  $600\text{--}700 \text{ V}$ . The second stage, decoupled from the first by means of an inductance, suppresses this value to approx.  $100 \text{ V}$ . This voltage pulse is then reduced to approx.  $35 \text{ V}$  (in a  $24 \text{ V}$  protective combination) by the suppression diode. Therefore, the downstream electronics need only be able to cope with a voltage pulse of approx.  $1.5 \times U_B$ .

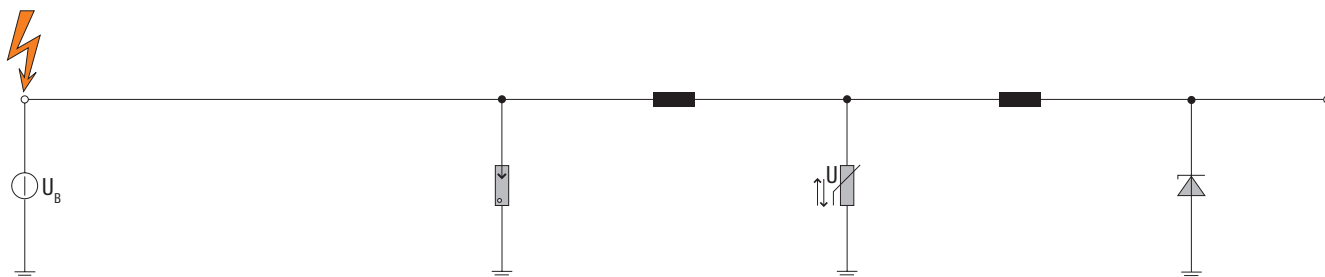
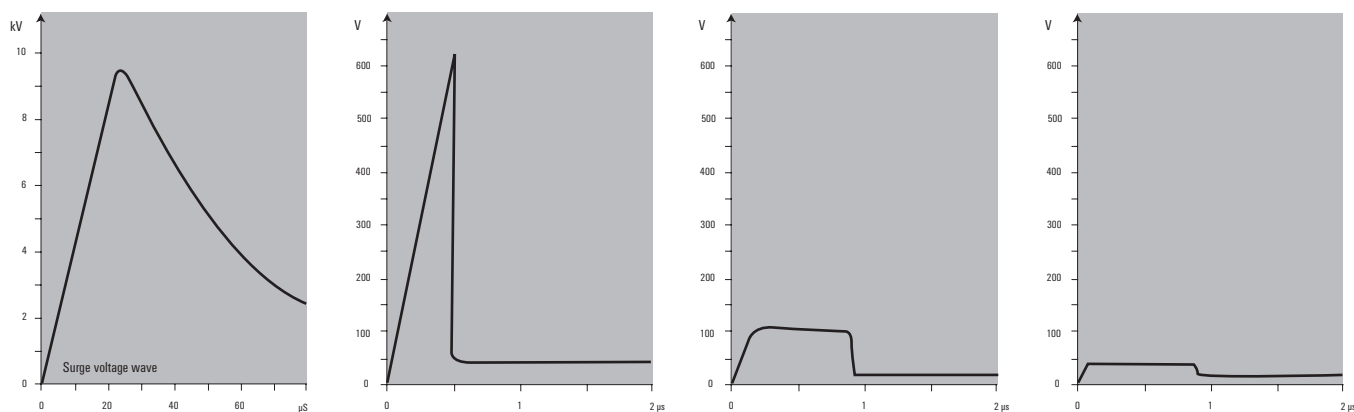

# Test criteria

The classification is based on the experience that "B arresters" can become overloaded in extreme situations, and also on more recent investigations into lightning discharges. This resulted in the standardised 10/350  $\mu$ s current curves for the testing of "Type I" arresters. The test parameters lie between 12,5 and 25 kA  $I_{peak}$  or  $I_{imp}$ . The term "10/350  $\mu$ s" means that the surge current reaches 90 % of its maximum value after 10  $\mu$ s and then decays to half that value after 350  $\mu$ s. The area beneath this curve corresponds to the current energy used in the test. As in the past, "Type II" arresters (formerly "C arresters") are tested with the 8/20  $\mu$ s current curve. The rated discharge current for our arresters: for a 2-pole feed up to 75 kA; for a 4-pole feed up to 100 kA. "Type III" arresters (formerly "D arresters") are used for protecting equipment. These are tested with a 2 W hybrid surge current generator delivering a maximum charging voltage of 0.1 to max. 20 kV,

Classification	formerly		Test values	Application
	VDE IEC 0675	37A		
Coarse protection	B-arrester	Type I	$I_{MP} = 25$ kA 10/350 $\mu$ s curve	Protection against direct lightning strike (incoming supply, main distribution board, etc.)
Medium protection	C-arrester	Type II	single pole $I_N = 20$ kA 8/20 $\mu$ s curve  3 or 4-pole $I_N = 100$ kA 8/20 $\mu$ s curve	Protection for permanent installations (electricity distribution etc.)
Fine protection	D-arrester	Type III	$U_{oc} = 20$ kV max. $I_s = 10$ kA max. hybrid generator	Protection for devices (sockets etc.)

which during a short-circuit supplies between 0.05 and 10 kA, 8/20  $\mu$ s.

## Relationship between 10/350 $\mu$ s and 8/20 $\mu$ s

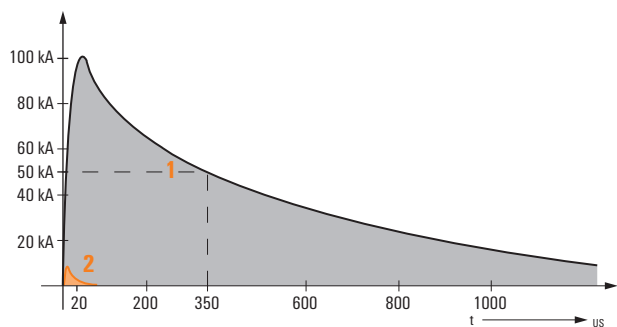

	1	2
Wave form [ $\mu$ s]	10/350	80/20
$I_{max}$ [kA]	100	5
$Q$ [As]	50	0.1
W/R [J/ $\Omega$ ]	$2.5 - 10^6$	$0.4 - 10^3$
Norm	DIN V VDE V 0185-1	DIN V VDE 0432 T.2

█ Simulated surge pulse 8/20  $\mu$ s  
█ Simulated lightning impulse 10/350  $\mu$ s

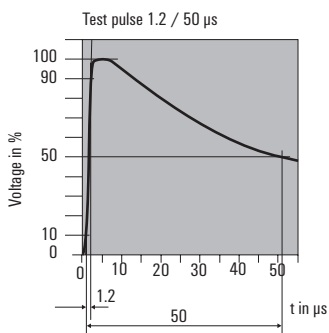
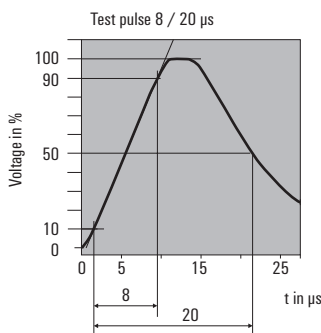
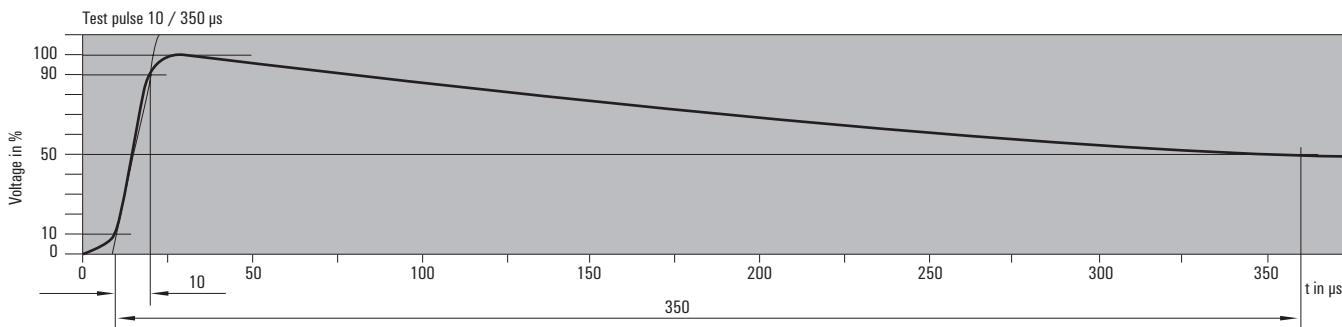

# Electromagnetic compatibility

EMC – electromagnetic compatibility – means the trouble-free interaction between electrical and electronic systems and devices without mutual interference. In this respect, any electrical item can act both as transmitter (source of interference) and receiver (potentially susceptible device) simultaneously.

Normally it is not sufficient to construct an EMC-compliant electrical or electronic system using EMC-compliant components and to then expect that everything will operate smoothly. Only when you use the proper surge protection devices in the proper places in the facility, can you operate without outages using coupled surge voltages. The method for using surge protection devices is also linked to the influence of interference sinks and interference sources. It integrates with the lightning protection zone strategy and insulation coordination to form a complete protection system.

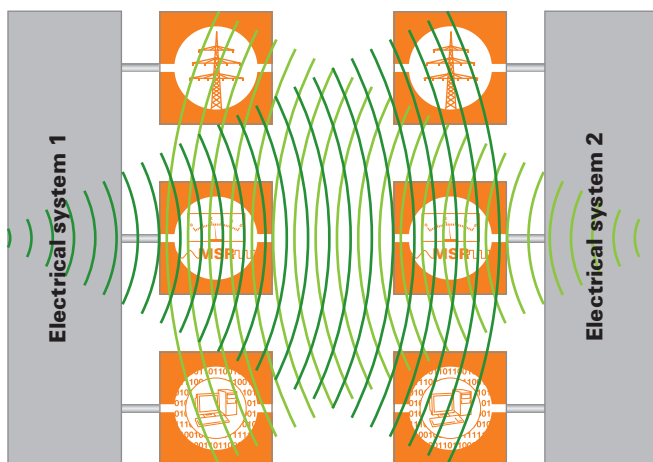

## EMC laws and directives

There are a multitude of standards and statutory requirements aimed at controlling mutual interference-free operation. With the establishment of the unified European market in 1989, the EEC Directive (EN 50-370 part 1+2) on electromagnetic compatibility was adopted and then implemented into national law. In Germany, the law on the electromagnetic compatibility (EMVG) was endorsed in 1992. The current version of this law was passed in 2008 as was the international standard IEC 61000. Electromagnetic influences can be caused by natural processes, e.g. a lightning strike, and also technical processes, e.g. high-speed changes in the status of currents and voltages. We distinguish between periodic interference (system hum, RF irradiation), transient interference (brief, often high-energy pulses) and noise (broad distribution of interference energy across the frequency range).

The model used in EMC observations designates the transmitter as the **source of interference** emission and the receiver as the **interference drain**. The transmission of the interference takes place via line-bound and/or field-bound (H-field/E-field) coupling mechanisms.

When considered as a source of interference, a device or a system may not exceed emissions thresholds specified in the EMC standards.

When considered as a potentially susceptible device, the same system must exhibit the immunity to interference specified in the standards.

However, the arrangement of various electrical systems within a complex plant or in a room and the many lines for power supplies, inputs and outputs to controls and bus systems give rise to diverse potential influences. Surges can be introduced by lightning, switching operations, etc. via the various coupling paths. This can lead to the following effects:

- Reduced functionality
- Malfunctions
- Failure of functions
- Damage

These last two functional interferences result in stoppages for entire production facilities and cause high breakdown costs.

The following points must be taken into account in order to achieve a system or plant that operates according to EMC guidelines:

- Lightning protection
- Earthing
- Routing of cables
- Cable shielding
- Panel construction
- Sensors and actuators
- Transmitters and receivers
- Frequency converters
- Bus and field devices
- ESD

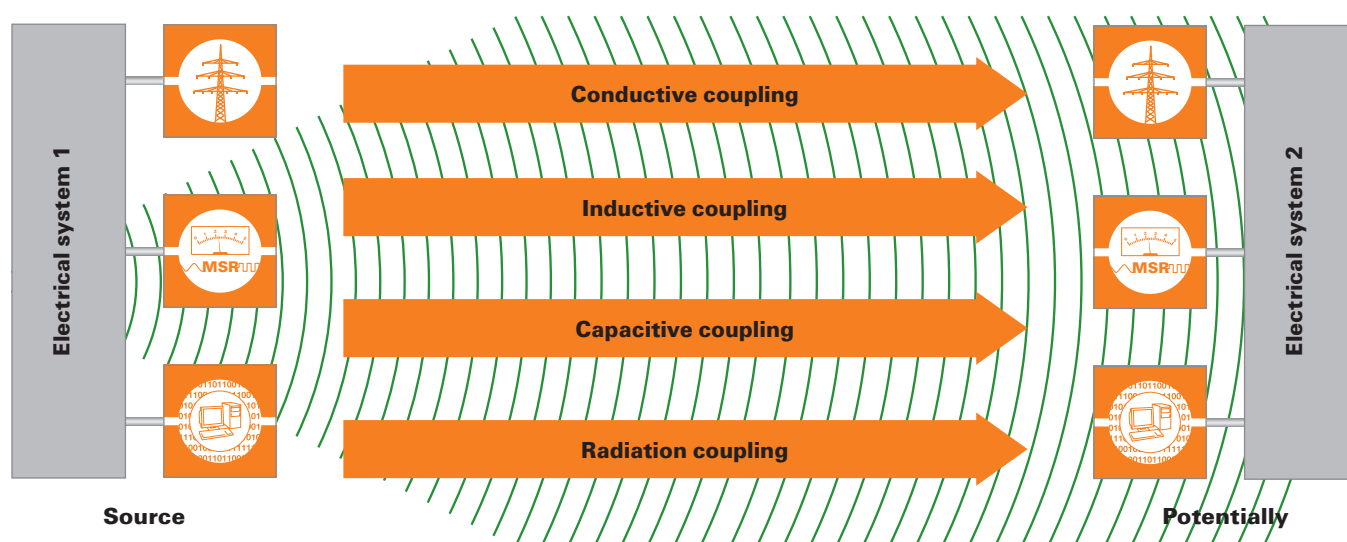

## FAQ list

### When do I need a Type I arrester, when a Type II arrester?

In a lightning protection system set up on a building, the Type I arrester achieves the lightning protection equipotential bonding for the supply voltage. The Type I arrester is used when higher pulses are expected and is installed in the vicinity of the incoming supply.

The Type I arrester is intended for use in lightning protection equipotential bonding, in compliance with DIN VDE 0185 part 1 and IEC 62305. The Type I arrester meets the requirements of Type I (B) DIN VDE 0675 and IEC 61643-1 Type I.

The Type II arrester is used to protect low-voltage consumer installations and electronic equipment against surge voltages arising from atmospheric discharges (thunderstorms) or switching operations. The Type II arresters comply with VDE 0675 part 6, Type II (C), Draft and DIN VDE 0675 part 6, A2 and the IEC 61643-11 Type II.

### When is a decoupling inductance needed?

When using Weidmüller arresters of Type I and II based on varistors, no decoupling inductance is needed. The PU1 TSG + operates with a triggered sparkover gap. The fast response and low protection level mean that no decoupling is required here either.

### Why are there 3- and 4-pole versions?

Various arresters are used depending on the network structure. A widely used network structure is the TN system. In the TN-C system, the electricity supply company routes the potential of the operational earth of the low-voltage source (transformer) to the consumer installation via the integral PEN conductor. The PE conductor has the same potential as the N conductor in this case. A 3-pole arrester is used here. Every rule has an exception: in the TN-S system, PE and N are separate. This means there can be a potential shift between PE and N. A 4-pole PU is used in this case. In addition, a combination of 3- or 4-pole modules reduces the amount of wiring.

### What other network structures are available?

#### TT-System

In the TT system, surge protection Type I/II arresters are not used between the active conductor and the earth potential like in TN systems. Instead they are used between phases L1, L2 and L3 and the neutral conductor.

In a "classic" arrangement of surge protection devices between the phases and the earth potential, the devices may not be capable of extinguishing mains follow currents at the end of their lifespan. They could even create a short circuit. Depending on the earth resistance that exists for the consumer installation, a fault current could flow back to the supply source. Usually, because of the relatively high loop resistances in TT systems, the fuses which conduct the operating current do not detect this fault current as a fault and thus do not isolate promptly. This can lead to increases in potential in the building's entire equipotential bonding system. Dangerous parasitic voltages can be transferred if more

distant buildings are being supplied from these consumer systems or if consumer loads are being operated via portable cables beyond the range of the building's equipotential bonding system. The 3+1 circuitry can be used in such instances.

#### IT-System

An IT system is set up in some consumer installations for reasons of availability. A single-phase earth fault practically creates a TN system. The power supply is not interrupted but instead maintained. IT systems are used in medical applications, for example. A device for monitoring insulation provides information on the quality of the insulation of active conductors and connected consumers in relation to the earth potential. Surge protection devices are incorporated between the active conductors and the main equipotential bonding. The fuses, conductor cross-section and conductor routes are handled as for T systems. Likewise, all active conductors are protected against local earth potential in sub-circuit distribution boards. VPU surge protection devices in Type III surge protection for end devices are used (such as VPU III or VPO DS) to protect sensitive consumer loads. The arrester must be sized for the voltage of the phase conductor.



### What does this have to do with the 3+1 circuitry?

If Type II arresters are now being led to a neutral conductor instead of a local earth in a TT system, then, for an arrester that has become low ohm, only the wire resistance of the neutral wire limits the incipient follow-on current. Immediately after the fault, this is isolated from the spur line fuses or from the main fuses that are carrying the operating current. A pure short-circuit current has emerged out of a fault current that was subject to an earthing facility and resistor. The connection between the neutral conductor and the main equipotential bonding is established using a spark gap. This conducts the total surge currents occurring at the installation site without overloading. This 3+1 circuitry is also implemented for the circuit distributors. The phase conductors L1, L2 and L3 are connected via the neutral conductor. From there, a spark gap link is established with the PE rail. The same information on the TN system applies when working with local equipotential bonding systems, when there is a separate discharge to the equipotential bonding, and when the surge protection components are being arranged ahead of the fault-current protective circuits.

### How does monitoring work with VPU arresters?

Each individual element of the PU arrester is equipped with a thermal monitoring mechanism. This state-of-the-art design isolates the aged arrester from the power supply network. This helps to prevent fires. This thermal monitoring mechanism functions using a special solder which separates itself within 30 seconds when a current of about 0.2 A flows through the varistor. The functionality is indicated when the viewing window is green, or for the

VPU series with arresters marked R, using a remote alert output with a CO contact.

### Does a lightning/surge protection system continue to operate after a surge voltage?

Yes, if the leakage current on, for example, the VPU II remains below the nominal leakage current for each individual disk. However the varistor does age during each discharge. The ageing accumulates over its lifetime and then leads to the failure of the arrester after several years. This can be monitored using remote signalling. Another method, which is required by IEC 62305-3, is a periodic check of the lightning protection system. The V-TEST can help by allowing you to test the function of each individual module.

### How are the VPU modules tested?

The VPU I and VPU II are tested in accordance with IEC 61643-11. The arresters from the VPU I series correspond with Type I and Type II. The VPU II series corresponds with Type II and Type III. The VPU III and VPO DS series are designed and tested in accordance with the requirements of IEC 61643-11. They are in Type III.

### Where are the VPU modules installed?

The dimensions of the VPU modules for installation distributors, comply with DIN 43 880 A1 draft 6/81. The Type I arresters are installed in the vicinity of the power feed and main equipotential bonding. The Type II arresters are installed in the distributor and the VPU III are installed in the sub-distributions, closer to the object being protected. The insulation co-ordination in DIN VDE 0110 requires that facility components have certain insulation strengths. This can be achieved through the gradual application of arresters in Type I, II and III.

### What must be considered when installing the VPU modules?

IEC 60364-5-53 describes the selection and installation of surge protection in buildings worldwide. The German draft standard VDE V 0100-534 describes the selection and set-up of surge protection systems.

### What is the difference between a spark gap and a varistor?

A varistor is a voltage-dependent resistor which switches off the surge voltage "softly". A spark gap is a mechanical component or an encapsulated, gas-filled ceramic unit whereby the spark gap switches through immediately, and after the spark, only the ignition voltage is present (80 – 120 V). Depending on the type of spark gap, the capability to suppress the 50-Hz mains follow-on current must also be considered. The varistors, however, do not draw any mains follow-on current.

### What are triggered spark gaps?

These spark gaps have additional electronics. They "see" the interference pulse and ignite the spark gap. This means that the protection level is kept low and the time to spark is reduced. This saves on decoupling coils.

### When should I use CL or SL circuits with surge protection components for measurement and control systems?

The difference between the switching in the CL (current loop) and SL (symmetrical loop) is the integration of the suppressor diodes. The CL circuit has a diode between the lines. This system is used for current loops and offers direct protection at the input or output of the analogue sensor. The SL circuit operates symmetrically to earth, i.e. two Transorb diodes are connected to earth. If this is used in a current loop instead of the CL circuit, the residual voltage is twice as high because there are two diodes instead of just the one of the CL circuit.

#### 2 CL protective circuit

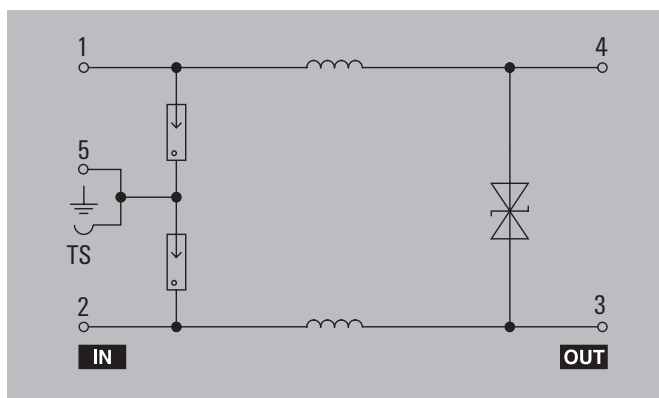

#### 2 SL protective circuit

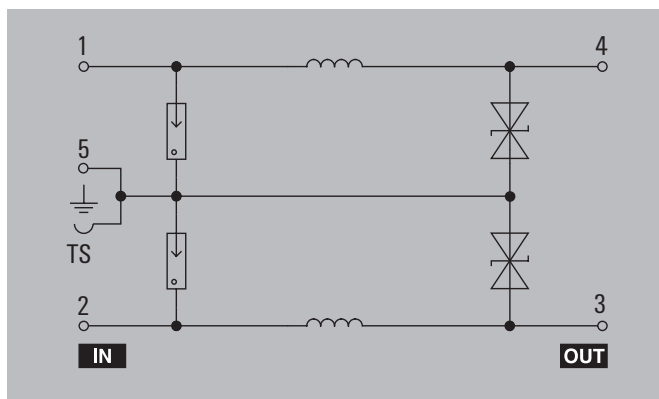



# Glossary

<b>3 + 1 circuit</b>	Surge protection for TT-/TNS power networks with 3 varistors and an N-PE spark gap. There are no parasitic voltages in the event of defective varistors.
<b>Ageing</b>	Change in the original power data caused by interference pulse due to operations or unfavourable environmental conditions.
<b>Arrester</b>	Protective device that discharges the energy either symmetrically between the conductors or asymmetrically between the cables and the earth.
<b>Asymmetric interference voltage</b>	Voltage between the "electrical centre", and common ground (earth). Voltage between conductor and signal ground (earth).
<b>Back-up fuse</b>	Dependent on the connection cross-section and/or maximum longitudinal decoupling of the proposed fuse.
<b>Binary signals</b>	Switching signals with on and off states.
<b>Burst</b>	For a surge pulse that reoccurs during a specific time interval.
<b>Cable lengths</b>	With a spur line connecting the lightning arrester, the length of the phase-side and earth-side cables should be kept as short as possible and should never be longer than 0.5 metres / 20 inch. The earth-side connection should be as short as possible. Installation site: At the feed point of the facility, for Type I and II. In the immediate vicinity of the end device being protected for Type III.
<b>Capacitive coupling</b>	Coupling of the interference circuit and the useful circuit because of a potential difference with coupling capacitances.
<b>Combination circuit</b>	Protective circuit (e.g. from gas discharge tube, varistor and/or suppressor diode)
<b>Combined pulse</b>	The hybrid generator, when idle, creates a 1.2/50 $\mu$ s pulse and, when in short circuit, a 8/20 $\mu$ s pulse. The ratio of peak open-circuit voltage ( $U_{Oc}$ ) to peak short-circuit current ( $I_{sc}$ ) is 2 ohms.
<b>Common-mode interference</b>	The interference source is between a signal wire and a reference conductor (e.g. capacitive coupling, or increase in potential of spatially dispersed earths).
<b>Continuous operating current <math>I_c</math></b>	Current per protective path for continuous voltage $U_c$ .
<b>Cut-off mechanism</b>	Device which disconnects the arrester in case of a system malfunction and displays this.
<b>Degree of protection for housing (IP code)</b>	Degree of protection ensured by the housing against touch access to live parts and against the ingress of solid foreign objects or water. Testing in accordance with IEC 529 section 7.4.
<b>Differential-mode interference</b>	Interference source and useful source are in series (e.g. magnetic or galvanic coupling).
<b>EMC</b>	Electromagnetic compatibility.
<b>External lightning protection</b>	The external lightning protection consists primarily of an air-termination device, arresters and an earthing system. It is responsible for protecting the facility buildings from lightning strikes which could cause fire or mechanical destruction.
<b>Follow-on current <math>I_f</math></b>	Current that flows through the surge protection device immediately following a discharge and is delivered from the power grid.
<b>Follow-on current extinguishing capability <math>I_{fi}</math></b>	The VPU I, II and III series do not generate any power follow current between L-PEN (follow current) and thus simplify the installation. Therefore, the strength of the short circuit current, or power follow current, from the generator or transformer, does not have to be taken into account.

<b>Fuse, back-up fuse</b>	A back-up fuse is required if the upstream fuse F1 is greater than the maximum value specified by the manufacturer. Remember to select the largest nominal value in keeping with the ratio F1 to F2 (back-up fuse before SPD) = 1 : 1.6. Be sure to take the triggering characteristics into account if a circuit breaker is being used in the surge protection equipment instead of the fuse specified in the installation instructions.
<b>Galvanic coupling</b>	The interference circuit and the useful circuit have a common impedance.
<b>Gas discharge tube</b>	Voltage-dependent, encapsulated switch with high current-carrying capacity.
<b>HAK</b>	House junction box.
<b>I&amp;C</b>	Measurement and control systems.
<b>IMAX</b>	Maximum current that can be switched by an arrester.
<b>Inductive coupling</b>	Coupling from two or more current-carrying conductor loops.
<b>Insertion loss (attenuation)</b>	Attenuation in decibels that is added by inserting a four-pole.
<b>INSTA</b>	Installation housing in accordance with DIN 43880, suitable for installation in distribution boards.
<b>Insulation co-ordination or rated impulse withstand voltage</b>	Standing surge current strength of the insulation in parts of the facility, according to DIN VDE 0110 T.1.
<b>Internal lightning protection</b>	Internal lightning protection refers to protecting electrical equipment from power surges.
<b>Intrinsically safe circuit</b>	Intrinsically safe circuits are especially vulnerable because even a small amount of energy is sufficient to nullify their intrinsic safety. During the installation of intrinsically safe circuits (including cables and wires), be sure that you do not exceed the maximum allowable inductance, capacitance, or the L/R ratio and the surface temperature.
<b><math>I_L</math></b>	Maximum nominal current via the internal cross-connection of an arrester with two connections for one phase.
<b><math>I_{peak} = I_{imp}</math></b>	Current peak value of a test pulse.
<b><math>I_{sn}</math></b>	Peak value of the nominal discharge current.
<b>IT power network</b>	Power system with three phase conductors, constructed with insulation to the earth potential. The building's PE is not connected to the power grid.
<b>Leakage current</b>	Current that flows to PE at nominal voltage.
<b>LEMP</b>	Lightning electromagnetic pulse = electromagnetic interference pulse.
<b>Lightning protection equipotential bonding</b>	Equipotential bonding of separated metal parts with the LPS using a direct connection or connection via surge protection devices in order to reduce the lightning current caused by the potential difference.
<b>Lightning pulse current <math>I_{imp}</math></b>	Defined by the peak value $I_{peak}$ and the charge Q, when tested in accordance with Type I with 10/350 $\mu$ s pulse.
<b>Limiting frequency</b>	Specifies the max. frequency at which a transfer will function. At higher frequencies, the protective circuit cushions so strongly that no transfer is possible.
<b>Longitudinal voltage</b>	Interference voltage between the active conductor and the earth.

## Glossary

<b>LPL</b>	Lightning protection level LPL I = 200 kA LPL II = 150 kA LPL III = 100 kA Maximum lightning current that can enter as a direct strike in the external lightning protection. Various applications and buildings are categorised according to these lightning protection levels. <b>10/350 µs</b> : test current for lightning arrester (Type I products), for simulating or reproducing a lightning bolt. <b>8/20 µs</b> : test current for lightning arrester (Type II products), for simulating or reproducing a surge voltage.
<b>LPS</b>	Lightning protection system – a complete system that is used to reduce the physical damage to a building or facility that could be caused by direct lightning strikes.
<b>LPZ</b>	Lightning protection zone = lightning protection zone The lightning protection zones are divided into: external lightning protection LPZ 0 / OA / OB and internal lightning protection LPZ 1, 2, 3.
<b>Max. continuous voltage <math>U_c</math></b>	The highest RMS value of the AC voltage or the highest value of the DC voltage that is allowed continually on the protective path of the surge protection device. Continual voltage = rated voltage.
<b>Maximum discharge surge current <math>I_{max}</math></b>	Peak value of the current 8/20 µs during duty test for Type II (type 40 kA).
<b>Measured limiting voltage</b>	Max. voltage level while loading with pulses of a specific form and amplitude during the test.
<b>MOV</b>	See varistor.
<b>Nominal discharge surge current</b>	At peak value of the surge current 8/20 µs, during test for Type II (type 20 kA)
<b>PAS main earth rail</b>	Metal rail which is connected with the foundation, and which can be used to connect metal installations, external conductive parts, power supply cables, telecommunications cables, water pipes and gas pipes to the LPS.
<b>PE</b>	Protective system and earth system to which energy is discharged.
<b>Protection level, <math>U_p</math></b>	Specifies the residual voltage that can still be measured at the terminals during a surge voltage pulse (preferred value is greater than the largest measured limiting voltage). Important parameter that characterises the performance of the SPD.
<b>Protective path</b>	Component circuitry in a SPD: conductor to conductor, conductor to earth, conductor to neutral, neutral to earth are designated as protective paths.
<b>Pulse current 10/350 µs</b>	Pulse voltage with a front time of 10 µs and a half-value time of 350 µs.
<b>Pulse current 8/20 µs</b>	Pulse voltage with a front time of 8 µs and a half-value time of 20 µs.
<b>Pulse voltage 1.2/50 µs</b>	Pulse voltage with a front time of 1.2 µs and a half-value time of 50 µs .
<b>Radiation coupling</b>	Electromagnetic field coupled to one or more conductive loops.
<b>Rated voltage UC</b>	The maximum RMS value of the AC voltage which may continuously be applied to an arrester.
<b>RCD circuit breaker</b>	If a fault current exceeds a certain threshold, then the RCD switches off within 0.2 seconds.
<b>Recommended fuse</b>	The nominal value of the fuse recommended by the manufacturer and specified by the technical data sheet.



<b>Remote alert contact (FM)</b>	A volt-free contact for the power products for signalling triggered/defective arresters. For the measurement/control SPD/VSPC products, this connection with the VSPC CONTROL UNIT is required to produce a signal. The Weidmüller diagrams show this with the letter R which stands for "remote signal contact".
<b>Requirement class B / T 1 / Type I</b>	For the purpose of lightning protection equipotential bonding according to DIN VDE 0185-1, also see Type I.
<b>Requirement class C / T 2 / Type II</b>	For the purpose of surge protection in the fixed facility, preferably for use in impulse withstand voltage category III, also see Type II.
<b>Requirement class D / T 3 / Type III</b>	For the purpose of surge protection in the fixed facility, preferably for use in impulse withstand voltage category II, also see Type III.
<b>RSU</b>	Surge protection on clip-on base with gas discharge tube, varistor and suppressor diode for 6-A and 10-A current loops
<b>Short-circuit withstand rating</b>	Maximum prospective short-circuit current that the surge protection device can withstand.
<b>Sparkover time</b>	Response times can vary between a few $\mu\text{s}$ to ps, depending on the type and construction of the protective components.
<b>SPD</b>	Surge protection device (lightning and surge protection device).
<b>Suppressor diode</b>	Voltage-dependent, fast-switching semiconductor diode.
<b>Surge protection (OVP/SPD)</b>	Switching circuitry/wiring of a circuit used to limit the output voltage; and the sum of all lightning protection measures used to protect the technical equipment against lightning currents and surge voltages.
<b>Surge protection device (SPD)</b>	Device with at least one non-linear component, used to limit the surge voltages and to discharge the surge currents.
<b>Surge protection equipment (SPE)</b>	Surge protection devices and surge protection equipment for a facility, including the cables associated with the surge protection .
<b>Surge voltage</b>	Unwanted continuous or short-term differences in potential between the conductors or between conductor and earth which create interference or destruction.
<b>Surge voltage protection classes</b>	Classification of electrical equipment in accordance with their dielectric strength relative to the nominal voltage, EN 50178.
<b>Symmetric interference voltage</b>	Voltage between the outward and return conductors (differential-mode voltage).
<b>TAZ</b>	See suppressor diode.
<b>TN power grid</b>	Power grid as a 4- or 5-wire system; 3 phases and the PEN come into the building. PE from the building and PE from power system are connected to each other.

<b>TOV error mode</b>	<p>TOV = arresters must be able to withstand persistent voltage increases with mains frequency, so-called "temporary overvoltages" or "TOVs". Various error states inside and outside the low voltage consumer facility of a building can occur to cause TOVs. An example of one of the causes of TOVs described in VDE 0100, part 442, is an earth fault on the high voltage side of the local grid transformer.</p> <p>Failure mode  Mode 1: Surge protection has switched itself off, no protection is being provided.  Mode 2: Surge protection has short circuited with an internal connection, the terminal equipment is protected by the short. The supply or the signal is no longer operational.</p>
<b>Transverse voltage</b>	Interference voltage between two conductors in circuit.
<b>Triggered sparkover gap</b>	A gas-filled sparkover gap which is ignited by a capacitive voltage divider with a pre-set voltage value.
<b>TT power grid</b>	Power system with 4 wires; 3-phase conductors and the neutral conductor come into the building. The building's PE is not connected to the power grid.
<b>Type I</b>	For the purpose of lightning protection equipotential bonding according to IEC 37A/44/CDV; also refer to requirement class B.
<b>Type II</b>	For the purpose of surge protection in the fixed facility, preferably for use in impulse withstand voltage category III, also see requirements class B.
<b>Type III</b>	For the purpose of surge protection in the fixed facility, preferably for use in impulse withstand voltage category II, also see requirements class B.
<b>Varistor</b>	Voltage-dependent metal oxide resistor; the resistance decreases with increasing voltage.



## Surge protection forum

# Construction standards/directives/legal basis

The continued availability of electrical and electronic equipment and systems is critical. It is therefore important to prevent loss and faults that are frequently caused by overvoltage events. It is for this reason that there are standards and directives for lightning and surge protection that cover buildings, parts of buildings, structural and technical installations (objects).

The technical committee IEC TC 81 deals with lightning protection issues worldwide. The new IEC 62305 standard was introduced following a decision in October 2001. Since January 2006, IEC 62305 has been divided into four parts:

- IEC 62305-1: General principles
- IEC 62305-2: Risk management
- IEC 62305-3: Physical damage to structures and life hazard
- IEC 62305-4: Electrical and electronic systems within structures

The German committee responsible for German implementation decided to maintain the VDE classification of the new standard series DIN EN 62305 as VDE 0185-305 parts 1-4.

### Country-specific standards and directives

- DIN EN 62305-1 (VDE 0185-305-1)
- DIN EN 62305-2 (VDE 0185-305-2)
- DIN EN 62305-3 (VDE 0185-305-3)
- DIN EN 62305-4 (VDE 0185-305-4)

It is known that lightning protection equipotential bonding is not sufficient in itself to protect electrical equipment from voltage surges.

On account of that, standards such as:

- DIN VDE 0100 part 410
- DIN VDE 0100 part 540
- DIN VDE 0100 part 443
- DIN VDE 0100 part 534
- DIN VDE 0800 part 1
- DIN VDE 0800 part 2
- DIN VDE 0800 part 10
- DIN VDE 0845 part 1
- DIN VDE 0845 part 2

explicitly require measures for protection against voltage surges. In DIN VDE 0100, the surge protection measures for low-voltage installations and, in the DIN VDE 0800 standard, the surge protection measures for communication engineering as a whole are described. Appendix A of DIN VDE V 0100-534 shows the selectively graded use of surge arresters of Type I (B arresters) in the main power supply, Type II (C arresters) in the sub-circuit

distribution board and Type III (D arresters) in the area of the final circuit. Appendix A of DIN VDE V 0100 part 534.

IEC 61643-5-53 has been available since 2002. It is implemented in VDE 0100-534 and describes the selection and installation of surge protection for electrical facilities. This is intended as a replacement for DIN VDE 0100-534. The international equivalent is IEC 60364-5-53:2002-06. The chapter 534: "Devices for protection against overvoltages" contains the devices for protection against overvoltages, the selection of these and their use in the building installation. The rules that apply on the low voltage side are adapted to communication electronics as a whole and are described by the national series of standards 0800 parts 1, 2 and 10 and 0845 parts 1 and 2. DIN VDE 0800 describes general issues such as earthing, equipotential bonding, etc. and DIN VDE 0845 the measures for protecting against overvoltage events of all kinds.

### Guidelines of the loss insurers

The guidelines apply to decisions on whether lightning and surge protection is to be provided for buildings, parts of buildings, structural and technical installations. The guidelines become, on agreement, a binding part of the insurance contract between insurer and policyholder.

However, their application does not exempt the insured party from observance of legislation, statutory instruments, official requirements and generally accepted codes of practice such as that described in the DIN VDE standards. The building regulations of different countries and the relevant statutory and official regulations and codes of practice, call for lightning protection systems to be installed in certain buildings for reasons of public safety, e.g. in shops, hospitals, schools

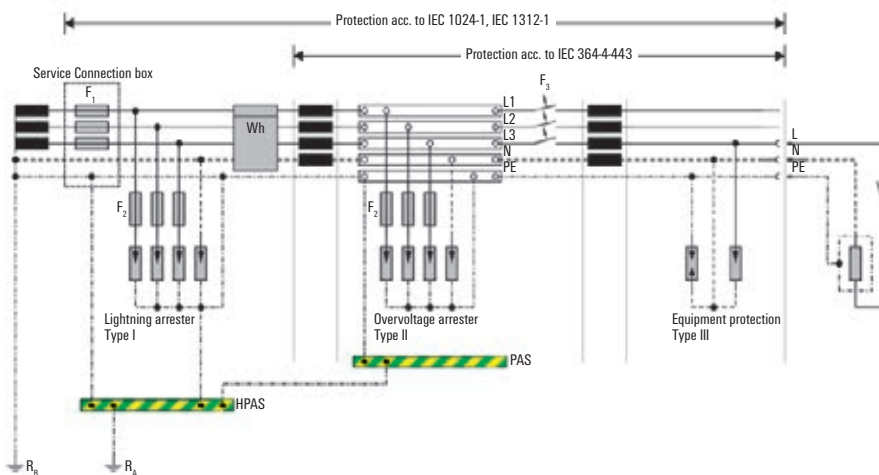

and children's homes, etc. The generally acknowledged code of practice, in this case DIN EN 62305 (VDE 0185-305):2006-11 or DIN VDE V 0185, must be adhered to when installing technical systems. Issues relating to installation arise not only in connection with official requirements but also when the insurers call for lightning protection, e.g. for high-racking warehouses or plants with a high risk of explosion. Similar relationships apply to surge protection. For example, DIN VDE 0100 part 443 specifies risk factors which determine the installation of surge protection measures.

The Association of German Property Insurers (VdS) publishes a number of documents covering particular applications, e.g. electrical installations, IT systems, agricultural businesses and residential buildings:

- VdS 2192: Leaflet on surge protection for loss prevention
- VdS 2014: Determining causes of damage due to lightning and surge
- VdS 2258: Protection against surge
- VdS 2006: Lightning protection by means of lightning arresters
- VdS 2017: Lightning and surge protection for agricultural businesses
- VdS 2031: Lightning and surge protection in electrical installations
- VdS 2028: Foundation earth electrodes for equipotential bonding and lightning protection earth termination
- VdS 2019: surge protection in residential buildings
- VdS 2569: surge protection for electronic IT systems
- VdS 2010: Risk-based lightning and surge protection
- VdS 2007: IT installations
- VdS 3428: surge protection devices

Furthermore, in Germany lightning protection is also covered in the construction law requirements of the individual federal states and also in national regulations. In light of this situation, the Association of German Property Insurers has produced a table to simplify the assignment of lightning protection classes and surge protection requirements to buildings and installations (VdS guideline 2010). This takes into account the experience and findings of loss prevention experts as well as legislation, official regulations and standards.

#### Legal basis

Basically, lightning and surge protection is not a mandatory provision in the form of legislation, even though lightning and surge protection is covered in Germany's EMC Act. However, it is important to know that there is indeed a legal basis. This comes into play when a loss event has occurred and, as a result, legal proceedings become relevant.

In Germany, the following legal aspects must be taken into account:

#### Civil law:

- **BGB (German Civil Code)**
  - cl. 633 Contractor's duty of warranty; removal of defects
  - cl. 276 Responsibility for one's own conduct
  - cl. 278 Responsibility for persons employed in performing an obligation
  - cl. 459 Liability for defect of quality
  - cl. 823b Unlawful actions

- **Produkthaftungsgesetz (Product Liability Act)**

- cl. 3 Identification of a defect/Competence

- **Gerätesicherheit (Safety of Equipment)**

- cl. 3 Code of practice

- **AVBEItV (General Conditions for Electricity Supplies to Standard-rate Customers)**

- Duty to observe the standards

#### Statutory instruments:

- **Gewerbeordnung (Trade and Industry Act)**

- cl. 24 Installations requiring monitoring
- cl. 120a Mortal danger and other health risks

- **VOB (Contract Procedures for Building Works)**

- cl. 3 Suspected defects
- cl. 4/2 Responsibility/Code of practice
- cl. 4/3 Written notification of concerns

**Basically, a person undertaking work is always liable for ensuring that his work is free from defects. The decisive starting point from which to establish whether work is free from defects is adherence to the generally accepted codes of practice.**

## Surge protection standards and regulations

In the case of national and international standards and specifications on the same subject, the document with the widest scope takes precedence (e.g. international "IEC", European "CENELEC" or "CNC", national (Germany) "DIN VDE" or Austria "ÖVE" (Similar to TÜV Germany, also valid in Austria.)).

IEC	EN	VDE	others	
	EN 60728-11			Cable distribution systems for television and sound signals – Part 11: Safety requirements
IEC 60364-5-53	HD 60364-5-53	VDE 0100-534		Electrical installations of buildings – Part 5-53: Selection and erection of electrical equipment – Isolation, switching and control – Part: 534: Surge protection device
IEC 60364-5-54	HD 60364-5-54	VDE 0100-540		Electrical installations of buildings – Part 5-54: Selection and erection of electrical equipment – Earthing arrangements, protective conductors and protective bonding conductors
IEC 60664-1	EN 60664-1	VDE 0110-1		Insulation coordination for equipment within low-voltage systems – Part 1: Principles, requirements and tests
IEC 60079-11	EN 60079-14	VDE 0165 Part 1		Electrical apparatus for use in the presence of combustible dust – Part 14: Selection and installation
IEC 60079-11	EN 60079-11	VDE 0170 Part 7		Explosive atmospheres – Part 11: Equipment protection by intrinsic safety "I"
IEC 62305-1	EN 62305-1	VDE 0185-305-1		Protection against lightning – Part 1: General principles
IEC 62305-2	EN 62305-2	VDE 0185-305-2		Protection against lightning – Part 2: Risk management
IEC 62305-3	EN 62305-3	VDE 0185-305-3		Protection against lightning – Part 3: Physical damage to structures and life hazard
IEC 62305-4	EN 62305-4	VDE 0185-305-4		Protection against lightning – Part 4: Electrical and electronic systems within structures
IEC 60529	EN 60 529	VDE 0470-1		Degrees of protection provided by enclosures (IP code)
IEC 60099-1	EN 60099-1	VDE 0675, Part 1		Surge arresters – Part 1: non-linear resistor type gapped surge arresters for A.C. systems
IEC 60099-4	EN 60099-4	VDE 0675, Part 4		Surge arresters – Part 4: Metal-oxide surge arresters without gaps for A.C. systems
IEC 60099-5	EN 60099-5	VDE 0675, Part 5		Surge arresters – Part 5: Selection and application recommendations
IEC 61643-11	EN 61643-11	VDE 0675-6-11	ÖVE SN 60 Part 1+4	Low-voltage surge protective devices – Part 11: Surge protective devices connected to low-voltage power systems – Requirements and tests
IEC 61643-12	EN 61643-12	VDE 0675-6-12		Surge protection devices for low voltage – Part 12: Selection and reasons for use
IEC 61643-21	EN 61643-21	VDE 845-3-1		Surge protection devices for low voltages – part 21: Surge protective devices for use in telecommunications and signal conditioning networks - Performance requirements and testing methods
IEC 61643-22	TS 61643-22	VDE V 845-3-2		Surge protection devices for low voltages – part 22: Surge protective devices for use in telecommunications and signal conditioning networks - Selection and application strategies
IEC 60038	EN 60038	VDE 0175-1		IEC standard voltages
			KTA 2206, 06.92	Lightning protection standard for nuclear power plants
			VDE publication 44	Lightning protection systems, explanations to DIN 57185/VDF 01 85, published by VDE
			DIN-VDE publication	Publication No. 519; Lightning protection systems 1, external lightning protection, published by VDE
			DKE publication No. 520	Publication No. 520; Lightning protection systems 2, internal lightning protection, published by VDE

The above list is not exhaustive.

IEC	EN	VDE	others	
			ÖVE 8001 §18	Protection of electrical systems from transient overvoltages
			DIN IEC 88/117CD (VDE 0127 Part 24): 2000-06	SPD for telecommunication selection and application principles
			IEC 61400-24	Wind power facilities - part 24: Lightning protection for wind turbines
			VdS 2010:2005-07 (03)	Wind turbine generator systems, Lightning protection for wind turbines
<b>The above list is not exhaustive.</b>				

<b>Risk-based lightning and surge protection, guidelines for damage prevention; VdS damage prevention in the German General Association of Property Insurers Association (GDV)</b>				
			VdS 2031	Lightning and surge protection for electrical facilities
			VdS 2019	Surge protection in residential buildings
			VdS 2258	Protection against surge voltages
			VdS 2569	Surge protection for electronic data processing computers/equipment
			DIN EN 61643-321 (VDE 0845-5-2):2003-02	Components for surge protection devices for low voltage, avalanche breakdown diodes (ABD) provision
			DIN EN 61643-331 (VDE 0845-5-3):2004-03	Components for surge protection devices for low voltage metal oxide varistors (MOV) provision
			DIN EN 61643-341 (VDE 0845-5-4):2002-11	Components for surge protection devices for low voltage suppressor diodes (TSS) provision
			VdS 3428: 2005-04	Directives for electrical equipment – surge protection devices (arresters)
			UTE C 61-740-51	French standard for testing SPDs in photovoltaic applications
			DIN CLC/TS 50539-12	Surge protection for low voltage – Surge protection devices for special applications including DC – part 12: Selection and application strategies – Surge protection devices for use in photovoltaic installations
	prEN 50539-11	VDE 0675-39-11		Preliminary standard for testing SPDs in photovoltaic applications
<b>The above list is not exhaustive.</b>				

**UL Approvals**

UL4976	UL Standard for measurement and control protection
UL94	UL Standard for plastic material





# Index

---

<b>Index</b>	Index Type	X.2
	Index Order No.	X.4
	Addresses worldwide	X.6

---

Type	Order No.	Page
------	-----------	------

## B

BNC Connector / M-F	8947820000	D.22
---------------------	------------	------

## E

EMC-CONTACT	1067520000	B.56
EMC-SET	1067470000	B.56
EMC-TIE	1067490000	B.56

## F

F Connector / M-F	8947840000	D.23
-------------------	------------	------

## J

JPOVP 24VDC MOV M12	8760960000	D.20
JPOVP M12 D-coded Cat5	8805570000	D.20
JPOVP RJ45 Cat6 IP20	8805550000	D.19
JPOVP RJ45 Cat6 IP67	8805560000	D.19

## K

KABELBINDERZANGE RT-1	1296000000	B.56
-----------------------	------------	------

## L

LPU RS 485	9454930000	B.3
------------	------------	-----

## M

MCZ OVP CL 115VUC 1,25A	8449060000	B.116
MCZ OVP CL 230VUC 1,25A	8449080000	B.117
MCZ OVP CL 24VAC 0,5A	8472880000	B.112
MCZ OVP CL 24VDC 0,5A	8448920000	B.112
MCZ OVP CL 24VUC 1,25A	8448960000	B.113
MCZ OVP CL 48VUC 0,5A	8449000000	B.114
MCZ OVP CL 48VUC 1,25A	8449040000	B.115
MCZ OVP CL FG 24VUC 0,5A	8704240000	B.118
MCZ OVP FILTER 24V 0,5A	8449100000	B.119
MCZ OVP GASABLEITER 90V	8449130000	B.120
MCZ OVP HF 12V 0,3A	8948610000	B.110
MCZ OVP HF 24V 0,3A	8948600000	B.111
MCZ OVP HF 5V 0,3A	8948620000	B.110
MCZ OVP LDN-Bus	8473470000	D.17
MCZ OVP SL 115VUC 1,25A	8449070000	B.117
MCZ OVP SL 230VUC 1,25A	8449090000	B.119
MCZ OVP SL 24VDC 0,5A	8448940000	B.113
MCZ OVP SL 24VUC 1,25A	8448970000	B.114
MCZ OVP SL 48VUC 0,5A	8449030000	B.115
MCZ OVP SL 48VUC 1,25A	8449050000	B.116
MCZ OVP SL FG 24VUC 0,5A	8823280000	B.118
MCZ OVP TAZ DIODE 24VDC	8449150000	B.121
MCZ OVP TAZ DIODE 24VUC	8449160000	B.121
MCZ OVP VARISTOR S10K30	8449140000	B.120

## N

N Connector / M-F	8947830000	D.22
-------------------	------------	------

## P

PLUG VPU	1402570000	C.37
PU I 1+1TSG+ 350V 1,5kV	8960500000	C.20
PU I 1TSG+ 350V 1,5kV	8960480000	C.20
PU I 3+1TSG+ 350V 1,5kV	8960510000	C.19
PU I 3TSG+ 350V 1,5kV	8960490000	C.19
PU III R 24V/4kV	8860360000	B.3
PU III R 48V/4kV	8860350000	B.2
PU I TSG Plus 330 VAC 0,9kV	8561220000	C.35
PU I TSG PLUS 440VAC 1,5kV	8561250000	C.35

## Q

QB 17,8/2	1309470000	B.57
QB 18-2 isoliert blau	8877550000	C.37
QB 18-2 isoliert grau	8877540000	C.37
QB 18-3 isoliert blau	8877530000	C.37
QB 18-3 isoliert grau	8877500000	C.37
QB 18-4 isoliert blau	8877510000	C.37
QB 18-4 isoliert grau	8877520000	C.37

## R

RS 485 K21 UE-SCHUTZ SE	8008501001	D.16
RSU 115VUC 10A	8104221001	B.124
RSU 115VUC 6A	1171561001	B.122
RSU 230VUC 10A LP	8093281001	B.124
RSU 230VUC 6A LP	1171661001	B.123
RSU 24VUC 6A LP	1171361001	B.122

## S

SEG-U LP	8007871001	B.3
----------	------------	-----

## T

TAE OVP analog LED	8674020000	D.27
TAE OVP ISDN LED	8674010000	D.27

Type	Order No.	Page
------	-----------	------

## U

UHF Connector / M-F	8947850000	D.23
---------------------	------------	------

## V

V-TEST	8951860000	B.62
VDATA CAT6	1348590000	B.3
VPU I 1 400V/25KA	1351820000	C.22
VPU I 1 280V/12,5KA	1352130000	C.31
VPU I 1 400V/12,5KA	1352290000	C.34
VPU I 1 LCF 280V/12,5KA	1352070000	C.26
VPU I 1 LCF 280V/25KA	1351590000	C.18
VPU I 1 LCF 280V/35KA	1351350000	C.15
VPU I 1 LCF 280V/50KA	1351250000	C.14
VPU I 1 LCF 400V/35KA	1351400000	C.15
VPU I 1 LCF 400V/50KA	1351300000	C.14
VPU I 1 N-PE 260V/100KA	1351920000	C.23
VPU I 1 N-PE 260V/50KA	1351900000	C.23
VPU I 1 N-PE 440V/100KA	1351970000	C.24
VPU I 1 N-PE 440V/50KA	1351950000	C.24
VPU I 1 R 400V/25KA	1351800000	C.22
VPU I 1 R 280V/12,5KA	1352140000	C.31
VPU I 1 R 300V/12,5KA	1352300000	C.34
VPU I 1 R LCF 280V/25KA	1351570000	C.18
VPU I 1 R LCF 280V/35KA	1351330000	C.15
VPU I 1 R LCF 280V/50KA	1351230000	C.14
VPU I 1 R LCF 400V/35KA	1351380000	C.15
VPU I 1 R LCF 400V/50KA	1351280000	C.14
VPU I 1+1 400V/25KA	1351840000	C.21
VPU I 1+1 280V/12,5KA	1352250000	C.32
VPU I 1+1 400V/12,5KA	1352320000	C.34
VPU I 1+1 LCF 280V/25KA	1351750000	C.17
VPU I 1+1 R 280V/12,5KA	1352270000	C.32
VPU I 1+1 R 400V/12,5KA	1352330000	C.34
VPU I 1+1RLCF280V/12,5KA	1352040000	C.25
VPU I 1+1R 400V/25KA	1351830000	C.21
VPU I 1+1RLCF 280V/25KA	1351740000	C.17
VPU I 1RLCF 280V/12,5KA	1352080000	C.26
VPU I 2 280V/12,5KA	1352150000	C.31
VPU I 2 LCF 280V/25KA	1351640000	C.18
VPU I 2 R 280V/12,5KA	1352170000	C.31
VPU I 2 R LCF 280V/25KA	1351620000	C.18
VPU I 2+0 R PV 600V DC	1351490000	C.59
VPU I 2+0 PV 1000V DC	1351470000	C.59
VPU I 2+0 PV 600V DC	1351520000	C.59
VPU I 2+0 R PV 1000V DC	1351430000	C.59
VPU I 3 400V/25KA	1351870000	C.22
VPU I 3 280V/12,5KA	1352200000	C.30
VPU I 3 400V/12,5KA	1352340000	C.33
VPU I 3 LCF 280V/12,5KA	1352090000	C.26
VPU I 3 LCF 280V/25KA	1351690000	C.16
VPU I 3 R 400V/25KA	1351850000	C.22
VPU I 3 R 280V/12,5KA	1352220000	C.30
VPU I 3 R 400V/12,5KA	1352350000	C.33
VPU I 3 R LCF 280V/25KA	1351670000	C.16
VPU I 3+1 400V/25KA	1351890000	C.21
VPU I 3+1 280V/12,5KA	1352230000	C.32
VPU I 3+1 400V/12,5KA	1352370000	C.33
VPU I 3+1 LCF 280V/25KA	1351780000	C.17
VPU I 3+1 R 280V/12,5KA	1352240000	C.32
VPU I 3+1 R 400V/12,5KA	1352380000	C.33
VPU I 3+1RLCF280V/12,5KA	1352020000	C.25
VPU I 3+1R 400V/25KA	1351880000	C.21
VPU I 3+1RLCF 280V/25KA	1351770000	C.17
VPU I 3RLCF 280V/12,5KA	1352100000	C.26
VPU I 4 280V/12,5KA	1352180000	C.30
VPU I 4 LCF 280V/25KA	1351730000	C.16
VPU I 4 R 280V/12,5KA	1352190000	C.30
VPU I 4 R LCF 280V/25KA	1351720000	C.16
VPU I 1+1RLCF280V/12,5KA	1352050000	C.25
VPU I 3+1RLCF280V/12,5KA	1352030000	C.25
VPU II 1 150V/40KA	1352470000	C.49
VPU II 1 280V/40KA	1352580000	C.40
VPU II 1 400V/40KA	1352830000	C.45
VPU II 1 600V/25KA	1352940000	C.53
VPU II 1 750V / 25KA	1351040000	C.56
VPU II 1 75V/30kA	1352390000	C.50
VPU II 1 LCF 280V/40KA	1352740000	C.42
VPU II 1 N-PE 260V/40KA	1351170000	C.46
VPU II 1 R 150V/40KA	1352480000	C.49
VPU II 1 R 280V/40KA	1352590000	C.40
VPU II 1 R 400V/40KA	1352840000	C.45
VPU II 1 R 600V/25KA	1352950000	C.53
VPU II 1 R 750V/25KA	1351050000	C.56
VPU II 1 R 75V/30kA	1352420000	C.50
VPU II 1+1 280V/40KA	1352630000	C.39
VPU II 1+1 R 280V/40KA	1352640000	C.39
VPU II 1R LCF 280V/40KA	1352750000	C.42
VPU II 2 150V/40KA	1352490000	C.49
VPU II 2 280V/40KA	1352600000	C.40
VPU II 2 400V/40KA	1352850000	C.45
VPU II 2 600V/25KA	1352970000	C.53
VPU II 2 750V/25KA	1351070000	C.56
VPU II 2 75V/30kA	1352430000	C.50
VPU II 2 PV 1000V DC	1351220000	C.60
VPU II 2 PV 600V DC	1351340000	C.61
VPU II 2 R 150V/40KA	1352500000	C.49
VPU II 2 R 280V/40KA	1352620000	C.40

Type	Order No.	Page
------	-----------	------

VPU II 2 R 400V/40KA	1352870000	C.45
VPU II 2 R 600V/25KA	1352980000	C.53
VPU II 2 R 750V/25KA	1351080000	C.56
VPU II 2 R 75V/30KA	1352440000	C.50
VPU II 2 R PV 1000V DC	1351240000	C.60
VPU II 2 R PV 600V DC	1351370000	C.61
VPU II 3 150V/40KA	1352520000	C.48
VPU II 3 280V/40KA	1352700000	C.38
VPU II 3 400V/40KA	1352880000	C.44
VPU II 3 600V/25KA	1352990000	C.52
VPU II 3 750V/25KA	1351090000	C.54
VPU II 3 LCF 280V/40KA	1352790000	C.41
VPU II 3 PV 1000V DC	1351270000	C.60
VPU II 3 PV 1200V DC	1351420000	C.61
VPU II 3 PV 1500V DC	1351500000	C.62
VPU II 3 R 150V/40KA	1352530000	C.48
VPU II 3 R 280V/40KA	1352720000	C.38
VPU II 3 R 400V/40KA	1352890000	C.44
VPU II 3 R 600V/25KA	1353000000	C.52
VPU II 3 R 750V/25KA	1351100000	C.54
VPU II 3 R PV 1000V DC	1351290000	C.60
VPU II 3 R PV 1200V DC	1351440000	C.61
VPU II 3 R PV 1500V DC	1351530000	C.62
VPU II 3+1 280V/40KA	1352650000	C.39
VPU II 3+1 750V/25KA	1351140000	C.55
VPU II 3+1 R 280V/40KA	1352670000	C.39
VPU II 3+1 R 750V/25KA	1351150000	C.55
VPU II 3R LCF 280V/40KA	1352800000	C.41
VPU II 4 150V/40KA	1352540000	C.48
VPU II 4 280V/40KA	1352680000	C.38
VPU II 4 400V/40KA	1352900000	C.44
VPU II 4 600V/25KA	1353020000	C.52
VPU II 4 750V/25KA	1351120000	C.54
VPU II 4 LCF 280V/40KA	1352770000	C.41
VPU II 4 R 150V/40KA	1352550000	C.48
VPU II 4 R 280V/40KA	1352690000	C.38
VPU II 4 R 400V/40KA	1352920000	C.44
VPU II 4 R 600V/25KA	1351020000	C.52
VPU II 4 R 750V/25KA	1351130000	C.54
VPU II 4R LCF 280V/40KA	1352780000	C.41
VPU III 3/280V	1393050000	C.71
VPU III R 12V/4kV AC/DC	1351550000	C.70
VPU III R 24V/4kV AC/DC	1351580000	C.69
VPU III R 48V/4kV AC/DC	1351600000	C.69
VPU III SO LD	1351680000	C.70
VPU III SO LD-A	1351700000	C.70
VPU IIIR 120V/6kV AC/DC	1351630000	C.68
VPU IIIR 230V/6kV AC	1351650000	C.68
VSPC 1CL 12VDC	8924450000	B.17
VSPC 1CL 12VDC EX	8953590000	B.147
VSPC 1CL 12VDC R	8951540000	B.19
VSPC 1CL 24VAC	8924500000	B.17
VSPC 1CL 24VAC R	8951560000	B.19
VSPC 1CL 24VDC	8924480000	B.17
VSPC 1CL 24VDC EX	8953600000	B.147
VSPC 1CL 24VDC R	8951550000	B.19
VSPC 1CL 48VAC	8924520000	B.1

Type	Order No.	Page
VSSC6 MOV 48VAC/DC	1064570000	B.79
VSSC6 MOV 60VAC/DC	1064600000	B.79
VSSC6 RS232	1064990000	B.67
VSSC6 RS485	1064980000	B.67
VSSC6 RS485 DP	1065010000	B.67
VSSC6 RS485 PA EX	1065020000	B.171
VSSC6 TAZ 12VDC	1064730000	B.87
VSSC6 TAZ 24VAC/DC	1064740000	B.87
VSSC6 TAZ 48VAC/DC	1064770000	B.87
VSSC6 TAZ 60VAC/DC	1064790000	B.87
VSSC6 CL 12VDC 0.5A	1064150000	B.67
VSSC6 CL 24VAC/DC 0.5A	1064170000	B.67
VSSC6 CL 48VAC/DC 0.5A	1064190000	B.67
VSSC6 CL 60VAC/DC 0.5A	1064210000	B.71
VSSC6 CLFG24VAC/DC0.5A	1064270000	B.67
VSSC6 CLFG48VAC/DC0.5A	1064280000	B.71
VSSC6 CLFG60VAC/DC0.5A	1064290000	B.71
VSSC6 GDT 110VAC/DC10kA	1064690000	B.67
VSSC6 GDT 110VAC/DC20kA	1064700000	B.67
VSSC6 GDT 240VAC/DC10kA	1064710000	B.83
VSSC6 GDT 240VAC/DC20kA	1064720000	B.67
VSSC6 GDT 24VAC/DC 10kA	1064640000	B.83
VSSC6 GDT 24VAC/DC 20kA	1064670000	B.83
VSSC6 RTD	1139710000	B.67
VSSC6 RTD EX	1130670000	B.173
VSSC6 TR CL 12VDC 0.5A	1064220000	B.73
VSSC6 TRCL24VAC/DC0.5A	1064230000	B.73
VSSC6 TRCL48VAC/DC0.5A	1064240000	B.73
VSSC6 TRCL60VAC/DC0.5A	1064250000	B.73
VSSC6 TRLDMOV 12VDC	1064800000	B.81
VSSC6 TRLDMOV 24VAC/DC	1064810000	B.81
VSSC6 TRLDMOV 48VAC/DC	1064820000	B.81
VSSC6 TRLDMOV120VAC/DC	1064840000	B.81
VSSC6 TRLDMOV150VAC/DC	1064850000	B.81
VSSC6 TRLDMOV240VAC/DC	1064860000	B.81
VSSC6 TRLDMOV60VAC/DC	1064830000	B.81
VSSC6 TRLDTAZ 12VDC	1064940000	B.87
VSSC6 TRLDTAZ 24VAC/DC	1064950000	B.87
VSSC6 TRLDTAZ 48VAC/DC	1064960000	B.87
VSSC6 TRLDTAZ 60VAC/DC	1064970000	B.87
VSSC6SL FG LD12VDC0.5A	1064420000	B.75
VSSC6SL LD 12VDC 0.5A	1064340000	B.67
VSSC6SL LD24VAC/DC0.5A	1064350000	B.75
VSSC6SL LD48VAC/DC0.5A	1064360000	B.75
VSSC6SL LD60VAC/DC0.5A	1064370000	B.75
VSSC6SLFGLD24VAC/DC0.5A	1064430000	B.75
VSSC6SLFGLD48VAC/DC0.5A	1064440000	B.75
VSSC6SLFGLD60VAC/DC0.5A	1064470000	B.75
VSSC6TRCLFG12VDC0.5A	1064300000	B.67
VSSC6TRCLFG24VAC/DC EX	1066490000	B.169
VSSC6TRCLFG24VAC/DC0.5A	1064310000	B.67
VSSC6TRCLFG48VAC/DC0.5A	1064320000	B.73
VSSC6TRCLFG60VAC/DC0.5A	1064330000	B.73
VSSC6TRGDT110VAC/DC10kA	1064890000	B.85
VSSC6TRGDT240VAC/DC10kA	1064920000	B.85
VSSC6TRGDT24VAC/DC10kA	1064870000	B.85
VSSC6TRSLFGLD12VDC0.5A	1064490000	B.77
VSSC6TRSLFGLD24VUC 0.5A	1064500000	B.77
VSSC6TRSLFGLD48VUC 0.5A	1064510000	B.77
VSSC6TRSLFGLD60VUC 0.5A	1064520000	B.77
VSSC6TRSLLD12VDC0.5A	1064380000	B.77
VSSC6TRSLLD24VAC/DC0.5A	1064390000	B.77
VSSC6TRSLLD48VAC/DC0.5A	1064400000	B.77
VSSC6TRSLLD60VAC/DC0.5A	1064410000	B.77

## W

WAVEFILTER 1A	8614790000	E.4
WAVEFILTER 3A	8614780000	E.4
WAVEFILTER 6A	8614800000	E.5
WAVEFILTER 10A	8614770000	E.5

Order No.	Type	Page
-----------	------	------

## 106000000

1063720000	VSSC4 CL 12VDC 0.5A	B.95
1063730000	VSSC4 CL 24VAC/DC 0.5A	B.95
1063740000	VSSC4 CL 48VAC/DC 0.5A	B.95
1063750000	VSSC4 CL 60VAC/DC 0.5A	B.95
1063760000	VSSC4 CL FG 12VDC 0.5A	B.95
1063770000	VSSC4 CL FG24VAC/DC0.5A	B.67
1063780000	VSSC4 CL FG48VAC/DC0.5A	B.95
1063790000	VSSC4 CL FG60VAC/DC0.5A	B.95
1063810000	VSSC4 CL FG 24VAC/DC Ex	B.163
1063820000	VSSC4 CL FG 48VAC/DC Ex	B.163
1063830000	VSSC4 SL 12VDC 0.5A	B.97
1063840000	VSSC4 SL 24VAC/DC 0.5A	B.97
1063860000	VSSC4 SL 48VAC/DC 0.5A	B.97
1063870000	VSSC4 SL 60VAC/DC 0.5A	B.97
1063880000	VSSC4 SL FG 12VDC 0.5A	B.97
1063890000	VSSC4 SL FG24VAC/DC0.5A	B.97
1063910000	VSSC4 SL FG48VAC/DC0.5A	B.97
1063920000	VSSC4 SL FG60VAC/DC0.5A	B.97
1063930000	VSSC4 SL FG 24VAC/DC Ex	B.165
1063940000	VSSC4 SL FG 48VAC/DC Ex	B.165
1063950000	VSSC4 MOV 12VDC	B.99
1063960000	VSSC4 MOV 24VAC/DC	B.99
1063970000	VSSC4 MOV 48VAC/DC	B.99
1063980000	VSSC4 MOV 60VAC/DC	B.99
1063990000	VSSC4 MOV 120VAC/DC	B.99
1064010000	VSSC4 MOV 150VAC/DC	B.99
1064020000	VSSC4 MOV 240VAC/DC	B.99
1064040000	VSSC4 GDT155VUC 20KA EX	B.167
1064050000	VSSC4 GDT 110VAC/DC20KA	B.101
1064060000	VSSC4 GDT 240VAC/DC20KA	B.101
1064070000	VSSC4 TAZ 12VDC	B.103
1064080000	VSSC4 TAZ 24VAC/DC	B.103
1064090000	VSSC4 TAZ 48VAC/DC	B.103
1064110000	VSSC4 TAZ 60VAC/DC	B.103
1064120000	VSSC4 RC 24VAC/DC	B.105
1064130000	VSSC4 RC 240VAC/DC	B.105
1064150000	VSSC6 CL 12VDC 0.5A	B.67
1064170000	VSSC6 CL 24VAC/DC 0.5A	B.67
1064190000	VSSC6 CL 48VAC/DC 0.5A	B.67
1064210000	VSSC6 CL 60VAC/DC 0.5A	B.71
1064220000	VSSC6 TR CL 12VDC 0.5A	B.73
1064230000	VSSC6 TRCL24VAC/DC0.5A	B.73
1064240000	VSSC6 TRCL48VAC/DC0.5A	B.73
1064250000	VSSC6 TRCL60VAC/DC0.5A	B.73
1064260000	VSSC6 CL FG 12VDC 0.5A	B.71
1064270000	VSSC6 CLFG24VAC/DC0.5A	B.67
1064280000	VSSC6 CLFG48VAC/DC0.5A	B.71
1064290000	VSSC6 CLFG60VAC/DC0.5A	B.71
1064300000	VSSC6TRCLFG 12VDC0.5A	B.67
1064310000	VSSC6TRCLFG24VAC/DC0.5A	B.67
1064320000	VSSC6TRCLFG48VAC/DC0.5A	B.73
1064330000	VSSC6TRCLFG60VAC/DC0.5A	B.73
1064340000	VSSC6SL LD 12VDC 0.5A	B.67
1064350000	VSSC6SL LD24VAC/DC0.5A	B.75
1064360000	VSSC6SL LD48VAC/DC0.5A	B.75
1064370000	VSSC6SL LD60VAC/DC0.5A	B.75
1064380000	VSSC6TRSLD12VDC0.5A	B.77
1064390000	VSSC6TRSLD24VAC/DC0.5A	B.77
1064400000	VSSC6TRSLD48VAC/DC0.5A	B.77
1064410000	VSSC6TRSLD60VAC/DC0.5A	B.77
1064420000	VSSC6SL FG LD12VDC0.5A	B.75
1064430000	VSSC6SLFGLD24VAC/DC0.5A	B.75
1064440000	VSSC6SLFGLD48VAC/DC0.5A	B.75
1064470000	VSSC6SLFGLD60VAC/DC0.5A	B.75
1064490000	VSSC6TRSLFGLD12VDC0.5A	B.77
1064500000	VSSC6TRSLFGLD24VAC 0.5A	B.77
1064510000	VSSC6TRSLFGLD48VAC 0.5A	B.77
1064520000	VSSC6TRSLFGLD60VAC 0.5A	B.77
1064530000	VSSC6 MOV 12VDC	B.79
1064540000	VSSC6 MOV 24VAC/DC	B.79
1064570000	VSSC6 MOV 48VAC/DC	B.79
1064600000	VSSC6 MOV 60VAC/DC	B.79
1064610000	VSSC6 MOV 120VAC/DC	B.79
1064620000	VSSC6 MOV 150VAC/DC	B.79
1064630000	VSSC6 MOV 240VAC/DC	B.79
1064640000	VSSC6 GDT 24VAC/DC 10kA	B.83
1064670000	VSSC6 GDT 24VAC/DC 20kA	B.83
1064690000	VSSC6 GDT 110VAC/DC10kA	B.67
1064700000	VSSC6 GDT 110VAC/DC20kA	B.67
1064710000	VSSC6 GDT 240VAC/DC10kA	B.83
1064720000	VSSC6 GDT 240VAC/DC20kA	B.83
1064730000	VSSC6 TAZ 12VDC	B.87
1064740000	VSSC6 TAZ 24VAC/DC	B.87
1064770000	VSSC6 TAZ 48VAC/DC	B.87
1064790000	VSSC6 TAZ 60VAC/DC	B.87
1064800000	VSSC6 TRLDMOV 12VDC	B.81
1064810000	VSSC6 TRLDMOV 24VAC/DC	B.81
1064820000	VSSC6 TRLDMOV 48VAC/DC	B.81
1064830000	VSSC6 TRLDMOV60VAC/DC	B.81
1064840000	VSSC6 TRLDMOV120VAC/DC	B.81
1064850000	VSSC6 TRLDMOV150VAC/DC	B.81
1064860000	VSSC6 TRLDMOV240VAC/DC	B.81
1064870000	VSSC6TRGDT24VAC/DC10kA	B.85
1064890000	VSSC6TRGDT110VAC/DC10kA	B.85
1064920000	VSSC6TRGDT240VAC/DC10kA	B.85
1064940000	VSSC6 TRLDTAZ 12VDC	B.87
1064950000	VSSC6 TRLDTAZ 24VAC/DC	B.87

Order No.	Type	Page
-----------	------	------

1064960000	VSSC6 TRLDTAZ 48VAC/DC	B.87
1064970000	VSSC6 TRLDTAZ 60VAC/DC	B.87
1064980000	VSSC6 RS485	B.67
1064990000	VSSC6 RS232	B.67
1065010000	VSSC6 RS485 DP	B.67
1065020000	VSSC6 RS485 PA EX	B.171
1066490000	VSSC6TRCLFG24VAC/DC EX	B.169
1067470000	EMC-SET	B.56
1067490000	EMC-TIE	B.56
1067520000	EMC-CONTACT	B.56

## 107000000

1070230000	VSPC BASE 1CL PW	B.28
1070470000	VSPC BASE 1CL PW FG EX	B.150

## 109000000

1093400000	VSPC 2CL 24VAC R	B.23
------------	------------------	------

## 110000000

1105700000	VSPC BASE 1CL PW FG	B.28
------------	---------------------	------

## 113000000

1130670000	VSSC6 RTD EX	B.173
1139710000	VSSC6 RTD	B.67

## 116000000

1161150000	VSPC 4SL 12VAC EX	B.155
1161170000	VSPC 4SL 12VDC EX	B.155
1161180000	VSPC 4SL 24VAC EX	B.155
1161190000	VSPC 4SL 24VDC EX	B.155

## 117000000

1171361001	RSU 24VUC 6A LP	B.122
1171561001	RSU 115VUC 6A	B.122
1171661001	RSU 230VUC 6A LP	B.123

## 129000000

1296000000	KABELBINDEZRANGE RT-1	B.56
------------	-----------------------	------

## 130000000

1309470000	QB 17,8/2	B.57
------------	-----------	------

## 131000000

1317340000	VSPC LOCKING CLIP	B.57
------------	-------------------	------

## 134000000

1348590000	VDATA CAT6	B.3
------------	------------	-----

## 135000000

1351020000	VPU II 4 R 600V/25kA	C.52
1351040000	VPU II 1 750V / 25kA	C.56
1351050000	VPU II 1 R 750V/25kA	C.56
1351070000	VPU II 2 750V/25kA	C.56
1351080000	VPU II 2 R 750V/25kA	C.56
1351090000	VPU II 3 750V/25kA	C.54
1351100000	VPU II 3 R 750V/25kA	C.54
1351120000	VPU II 4 750V/25kA	C.54
1351130000	VPU II 4 R 750V/25kA	C.54
1351140000	VPU II 3+1 750V/25kA	C.55
1351150000	VPU II 3+1 R 750V/25kA	C.55
1351170000	VPU II 1 N-PE 260V/40kA	C.46
1351220000	VPU II 2 PV 1000V DC	C.60
1351230000	VPU I 1 R LCF 280V/50kA	C.14
1351240000	VPU II 2 R PV 1000V DC	C.60
1351250000	VPU I 1 LCF 280V/50kA	C.14
1351270000	VPU II 3 PV 1000V DC	C.60
1351280000	VPU I 1 R LCF 400V/50kA	C.14
1351290000	VPU II 3 R PV 1000V DC	C.60
1351300000	VPU I 1 LCF 400V/50kA	C.14
1351330000	VPU I 1 R LCF 280V/35kA	C.15
1351340000	VPU II 2 PV 600V DC	C.61
1351350000	VPU I 1 LCF 280V/35kA	C.15
1351370000	VPU II 2 R PV 600V DC	C.61
1351380000	VPU I 1 R LCF 400V/35kA	C.15
1351400000	VPU I 1 LCF 400V/35kA	C.15
1351420000	VPU II 3 PV 1200V DC	C.61
1351430000	VPU I 2+0 R PV 1000V DC	C.59
1351440000	VPU II 3 R PV 1200V DC	C.61
1351470000	VPU I 2+0 PV 1000V DC	C.59
1351490000	VPU I 2+0 R PV 600V DC	C.59
1351500000	VPU II 3 PV 1500V DC	C.62
1351520000	VPU I 2+0 PV 600V DC	C.59
1351530000	VPU II 3 R PV 1500V DC	C.62
1351550000	VPU III 2 R 12V/4kV AC/DC	C.70
1351570000	VPU I 1 R LCF 280V/25kA	C.18
1351580000	VPU III 2 R 24V/4kV AC/DC	C.18
1351590000	VPU I 1 R LCF 280V/25kA	C.18
1351600000	VPU III 2 R 48V/4kV AC/DC	C.69

Order No.	Type	Page
-----------	------	------

1351620000	VPU I 2 R LCF 280V/25kA	C.18
1351630000	VPU III 2 R 120V/6kV AC/DC	C.68
1351640000	VPU I 2 LCF 280V/25kA	C.18
1351650000	VPU III 2 R 230V/6kV AC	C.68
1351670000	VPU I 3 R LCF 280V/25kA	C.16
1351680000	VPU III SO LD	C.70
1351690000	VPU I 3 LCF 280V/25kA	C.16
1351700000	VPU III SO LD+A	C.70
1351720000	VPU I 4 R LCF 280V/25kA	C.16
1351730000	VPU I 4 LCF 280V/25kA	C.16
1351740000	VPU I 1+1 R LCF 280V/25kA	C.17
1351750000	VPU I 1+1 LCF 280V/25kA	C.17
1351770000	VPU I 3+1 R LCF 280V/25kA	C.17
1351780000	VPU I 3+1 LCF 280V/25kA	C.17
1351800000	VPU I 1 R 400V/25kA	C.22
1351820000	VPU I 1 400V/25kA	C.22
1351830000	VPU I 1+1 R 400V/25kA	C.21
1351840000	VPU I 1+1 400V/25kA	C.21
1351850000	VPU I 3 R 400V/25kA	C.22
1351870000	VPU I 3 400V/25kA	C.22
1351880000	VPU I 3+1 R 400V/25kA	C.21
1351890000	VPU I 3+1 400V/25kA	C.21
1351900000	VPU I 1 N-PE 260V/50kA	C.23
1351920000	VPU I 1 N-PE 260V/100kA	C.23
1351950000	VPU I 1 N-PE 440V/50kA	C.24
1351970000	VPU I 1 N-PE 440V/100kA	C.24
1352020000	VPU I 3+1 LCF 280V/12.5kA	C.25
1352030000	VPU I 3+1 R LCF 280V/12.5kA	C.25
1352040000	VPU I 1+1 LCF 280V/12.5kA	C.25
1352050000	VPU I 1+1 R LCF 280V/12.5kA	C.25
1352070000	VPU I 1 LCF 280V/12.5kA	C.26
1352080000	VPU I 1 R LCF 280V/12.5kA	C.26
1352090000	VPU I 3 LCF 280V/12.5kA	C.26
1352100000	VPU I 3 R LCF 280V/12.5kA	C.26
1352130000	VPU I 1 280V/12.5kA	C.31
1352140000	VPU I 1 R 280V/12.5kA	C.31
1352150000	VPU I 2 280V/12.5kA	C.31
1352170000	VPU I 2 R 280V/12.5kA	C.31
1352180000	VPU I 4 280V/12.5kA	C.30
1352190000	VPU I 4 R 280V/12.5kA	C.30
1352200000	VPU I 3 280V/12.5kA	C.30
1352220000	VPU I 3 R 280V/12.5kA	C.30
1352230000	VPU I 3+1 280V/12.5kA	C.32
1352240000	VPU I 3+1 R 280V/12.5kA	C.32
1352250000	VPU I 1+1 280V/12.5kA	C.32
1352270000	VPU I 1+1 R 280V/12.5kA	C.32
1352290000	VPU I 1 400V/12.5kA	C.34
1352300000	VPU I 1 R 400V/12.5kA	C.34
1352320000	VPU I 1+1 400V/12.5kA	C.34
1352330000	VPU I 1+1 R 400V/12.5kA	C.34
1352340000	VPU I 3 400V/12.5kA	C.33
1352350000	VPU I 3 R 400V/12.5kA	C.33
1352370000	VPU I 3+1 400V/12.5kA	C.33
1352380000	VPU I 3+1 R 400V/12.5kA	C.33
1352390000	VPU II 1 75V/30kA	C.50
1352420000	VPU II 1 R 75V/30kA	C.50
1352430000	VPU II 2 75V/30kA	C.50
1352440000	VPU II 2 R 75V/30kA	C.50
1352470000	VPU II 1 150V/40kA	C.49
1352480000	VPU II 1 R 150V/40kA	C.49
1352490000	VPU II 2 150V/40kA	C.49
1352500000	VPU II 2 R 150V/40kA	C.49
1352520000	VPU II 3 150V/40kA	C.48
1352530000	VPU II 3 R 150V/40kA	C.48
1352540000	VPU II 4 150V/40kA	C.48
1352550000	VPU II 4 R 150V/40kA	C.48
1352580000	VPU II 1 2	

Order No.	Type	Page
8924220000	VSPC 4SL 12VDC	B.35
8924230000	VSPC 2SL 12VDC	B.31
8924240000	VSPC 4SL 12VAC	B.35
8924250000	VSPC 2SL 12VAC	B.31
8924260000	VSPC BASE 4SL FG	B.53
8924270000	VSPC BASE 2CL FG	B.53
8924280000	VSPC BASE 2SL FG	B.53
8924290000	VSPC BASE 1CL FG	B.53
8924300000	VSPC BASE 2/4CH FG	B.53
8924320000	VSPC 4SL 24VDC	B.35
8924330000	VSPC 2SL 24VDC	B.31
8924340000	VSPC 4SL 24VAC	B.35
8924350000	VSPC 2SL 24VAC	B.31
8924360000	VSPC 4SL 48VAC	B.35
8924370000	VSPC 2SL 48VAC	B.31
8924380000	VSPC 4SL 60VAC	B.35
8924390000	VSPC 2SL 60VAC	B.31
8924400000	VSPC 2CL 5VDC	B.21
8924420000	VSPC 1CL 5VDC	B.17
8924430000	VSPC 2CL HF 5VDC	B.25
8924440000	VSPC 2CL 12VDC	B.21
8924450000	VSPC 1CL 12VDC	B.17
8924460000	VSPC 2CL HF 12VDC	B.25
8924470000	VSPC 2CL 24VDC	B.21
8924480000	VSPC 1CL 24VDC	B.17
8924490000	VSPC 2CL 24VAC	B.21
8924500000	VSPC 1CL 24VAC	B.17
8924510000	VSPC 2CL HF 24VDC	B.25
8924520000	VSPC 1CL 48VAC	B.17
8924530000	VSPC 1CL 60VAC	B.17
8924540000	VSPC 3/4WIRE 5VDC	B.39
8924550000	VSPC 3/4WIRE 24VDC	B.39
8924570000	VSPC GDT 2CH 90V	B.41
8924590000	VSPC GDT 2CH 150Vac/230Vdc	B.41
8924600000	VSPC MOV 2CH 24V	B.43
8924610000	VSPC MOV 2CH 230V	B.43
8924640000	VSPC TAZ 2CH 24V	B.45
8924650000	VSPC TAZ 4CH 24V	B.45
8924660000	VSPC TELE UKO 2WIRE	B.47
8924670000	VSPC RS485 2CH	B.49
8924680000	VSPC GROUND	B.56
8924690000	VSPC TEST CONNECTOR	B.56
8924700000	VSPC BASE 4SL	B.52
8924710000	VSPC BASE 2CL	B.52
8924720000	VSPC BASE 2SL	B.52
8924730000	VSPC BASE 1CL	B.52
8924730000	VSPC BASE 1CL	B.3
8924740000	VSPC BASE 2/4CH	B.52

## 8940000000

8947820000	BNC Connector / M-F	D.22
8947830000	N Connector / M-F	D.22
8947840000	F Connector / M-F	D.23
8947850000	UHF Connector / M-F	D.23
8948600000	MCZ OVP HF 24V 0,3A	B.111
8948610000	MCZ OVP HF 12V 0,3A	B.110
8948620000	MCZ OVP HF 5V 0,3A	B.110

## 8950000000

8951460000	VSPC 2CL 5VDC R	B.23
8951470000	VSPC 2CL 12VDC R	B.23
8951480000	VSPC 2CL 24VDC R	B.23
8951490000	VSPC 2CL 48VAC	B.21
8951500000	VSPC 2CL 60VAC	B.21
8951510000	VSPC 1CL PW 24V	B.29
8951530000	VSPC 1CL 5VDC R	B.19
8951540000	VSPC 1CL 12VDC R	B.19
8951550000	VSPC 1CL 24VDC R	B.19
8951560000	VSPC 1CL 24VAC R	B.19
8951570000	VSPC 4SL 5VDC R	B.37
8951580000	VSPC 4SL 12VDC R	B.37
8951590000	VSPC 4SL 24VDC R	B.37
8951600000	VSPC 4SL 24VAC R	B.37
8951610000	VSPC 2SL 5VDC R	B.33
8951620000	VSPC 2SL 12VDC R	B.33
8951630000	VSPC 2SL 24VDC R	B.33
8951640000	VSPC 2SL 24VAC R	B.33
8951650000	VSPC MOV 2CH 24V R	B.43
8951660000	VSPC MOV 2CH 230V R	B.43
8951670000	VSPC RS485 2CH R	B.51
8951680000	VSPC 2CL HF 5VDC R	B.27
8951690000	VSPC 2CL HF 12VDC R	B.27
8951700000	VSPC 2CL HF 24VDC R	B.27
8951710000	VSPC BASE 2CL R	B.54
8951720000	VSPC BASE 2CL FG R	B.55
8951730000	VSPC BASE 1CL R	B.54
8951740000	VSPC BASE 1CL FG R	B.55
8951750000	VSPC BASE 4SL R	B.54
8951760000	VSPC BASE 4SL FG R	B.55
8951770000	VSPC BASE 2SL R	B.54
8951780000	VSPC BASE 2SL FG R	B.55
8951790000	VSPC BASE 2/4CH R	B.54
8951800000	VSPC BASE 2/4CH FG R	B.55
8951810000	VSPC BASE 1CL FG EX	B.158
8951820000	VSPC BASE 2CL FG EX	B.158
8951830000	VSPC BASE 2SL FG EX	B.158
8951840000	VSPC BASE 4SL FG EX	B.158

Order No.	Type	Page
8951860000	V-TEST	B.62
8953590000	VSPC 1CL 12VDC EX	B.147
8953600000	VSPC 1CL 24VDC EX	B.147
8953610000	VSPC 1CL PW 24V EX	B.151
8953620000	VSPC 2SL 12VDC EX	B.153
8953630000	VSPC 2SL 12VAC EX	B.153
8953640000	VSPC 2SL 48VAC EX	B.153
8953650000	VSPC 3/4WIRE 5VDC EX	B.157
8953660000	VSPC 1CL 5VDC EX	B.147
8953670000	VSPC 2SL 24VDC EX	B.153
8953720000	VSPC 2CL 24VDC EX	B.149

## 8960000000

8960480000	PU I 1TSG+ 350V 1,5kV	C.20
8960490000	PU I 3TSG+ 350V 1,5kV	C.19
8960500000	PU I 1+1TSG+ 350V 1,5kV	C.20
8960510000	PU I 3+1TSG+ 350V 1,5kV	C.19

## 8970000000

8972270000	VSPC CONTROL UNIT 24VDC	B.58
------------	-------------------------	------

## 9450000000

9454930000	LPU RS 485	B.3
------------	------------	-----





We cannot guarantee that there are no mistakes in the publications or software provided by us to the customer for the purpose of making orders. We try our best to quickly correct errors in our printed media.

**X**

All orders are based on our general terms of delivery, which can be reviewed on the websites of our group companies where you place your order. On demand we can also send the general terms of delivery to you.

# Examples of applications in 230/400 V systems

## TN-C system application

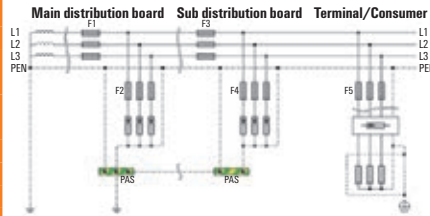

## TN-C 230/400 V

### Ordering data

Class I (B arrester)	Lightning protection level	Type	Order No.	Page	Remarks
High-power varistor with spark gap (no leakage current)	I/II	VPU I 3 LCF 280 V/25 kA	1351690000	C.15	No decoupling necessary
High-power varistor	III / IV	VPU I 3 280 V/12,5 kA	1352090000	C.21	No decoupling necessary, install behind RCD
Class II (C arrester)	Type		Order No.	Page	Remarks
Varistor	VPU II 3 280 V/40 kA		1352700000	C.38	Install behind RCD
Class III (D arrester)	Type		Order No.	Page	Remarks
Hybrid circuit	VPU III 230 V/16 A		1351650000	C.66	Install behind RCD, with FM contact

## TN-C-S system application

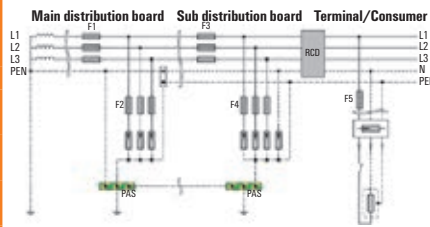

## TN-C-S 230/400 V with 3+1 circuit and

### TN-S system with 4-pole protection circuit

### Ordering data

Class I	Lightning protection level	Type	Order No.	Page	Remarks
High-power varistor with spark gap (no leakage current)	I/II	VPU I 3+1 LCF 280 V/25 kA	1351780000	C.16	No decoupling necessary
High-power varistor with spark gap (no leakage current)	I/II	VPU I 3 LCF 280 V/25 kA	1351690000	C.15	No decoupling necessary
High-power varistor with spark gap (no leakage current)	III/IV	VPU I 3+1 LCF 280 V/12,5 kA	1352020000	C.17	No decoupling necessary
Class II (C arrester)	Type		Order No.	Page	Remarks
Varistor + N-PE spark gap	VPU II 3+1 280 V/40 kA		1352650000	C.40	Including N-PE spark gap, install behind RCD
Varistor	VPU II 4 280 V/40 kA		1352680000	C.38	Install behind RCD
Class III (D arrester)	Type		Order No.	Page	Remarks
Hybrid circuit	VPU III 230 V/16 A		1351650000	C.66	Install behind RCD, with FM contact

## TN-S system application

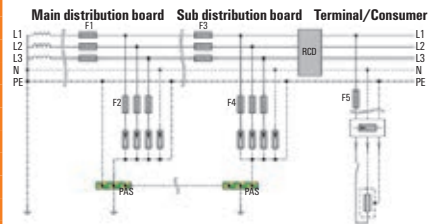

## TT system application

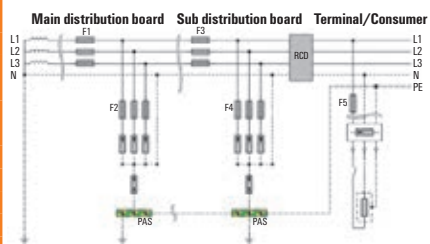

## TT 230/400 V with 3+1 circuit

### Ordering data

Class I	Lightning protection level	Type	Order No.	Page	Remarks
High-power varistor with spark gap (no leakage current)	I/II	VPU I 3+1 LCF 280 V/25 kA	1351780000	C.16	No decoupling necessary
High-power varistor with spark gap (no leakage current)	III/IV	VPU I 3+1 LCF 280 V/12,5 kA	1352020000	C.17	No decoupling necessary
Class II (C arrester)	Type		Order No.	Page	Remarks
Varistor + N-PE spark gap	VPU II 3+1 280 V/40 kA		1352650000	C.40	Including N-PE spark gap, install behind RCD
Varistor	VPU II 4 280 V/40 kA		1352680000	C.38	Install behind RCD
Class III (D arrester)	Type		Order No.	Page	Remarks
Hybrid circuit	VPU III 230 V/16 A		1351650000	C.66	Install behind RCD, with FM contact

## IT system application

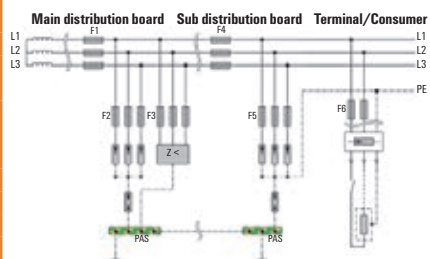

## IT 230/400 V with 3+1 circuit

### Ordering data

Class I	Lightning protection level	Type	Order No.	Page	Remarks
High-power varistor with spark gap (no leakage current)	I/II	VPU I 3+1 LCF 280 V/25 kA	1351780000	C.16	No decoupling necessary
High-power varistor with spark gap (no leakage current)	III/IV	VPU I 3+1 LCF 280 V/12,5 kA	1352020000	C.17	No decoupling necessary
Class II (C arrester)	Type		Order No.	Page	Remarks
Varistor + N-PE spark gap	VPU III 3+1 280 V/40 kA		1352650000	C.40	Including N-PE spark gap, install behind RCD
Varistor	VPU II 4 280 V/40 kA		1352680000	C.38	Install behind RCD
Class III (D arrester)	Type		Order No.	Page	Remarks
Hybrid circuit	VPU III 230 V/16 A		1351650000	C.66	Install behind RCD, with FM contact

For further applications/voltage levels, please ask Weidmüller. All arresters also available with telecommunication contact.

# Terms

**SPD = Surge Protection Device**

## Classification of surge arresters

### 1. Power lines

- Class I, Type 1, Type 1 (lightning arrester)
- Class II, Type 2, Type 2 (surge protection)
- Class III, Type 3, Type 3 (surge protection for end devices)

### 2. Measurement/control cables and data cables

- Class D1 (lightning arrester)
- Class C2 (surge protection)
- Class C1 (surge protection for end devices)

## Surge voltage category (EN 60664-1)

### Rated impulse voltage

- IV = 6 kV (before the meter)
- III = 4 kV (after the meter, HV + UV, fixed installation)
- II = 2.5 kV (outlet/end device)
- I = 1.5 kV (in end device)

### LPZ = Lightning Protection Zone

- External lightning protection LPZ 0 / 0A / 0B
- Internal lightning protection LPZ 1, 2, 3

### LPL = Lightning Protection Level

- I = 200 kA
- II = 150 kA
- III + IV = 100 kA

### LPS = Lightning Protection System

Lightning protection system

### SPM = Surge Protection Measures

### International standards

- Application standard:
- IEC 62305 – Application of lightning and surge protection with 4 chapters: General overview, Risk analysis, Internal and external lightning protection
- IEC 61643-12 – Usage for energy protection
- IEC 61643-22 – Usage for measurement and control signals

## Testing pulse for surge arrester

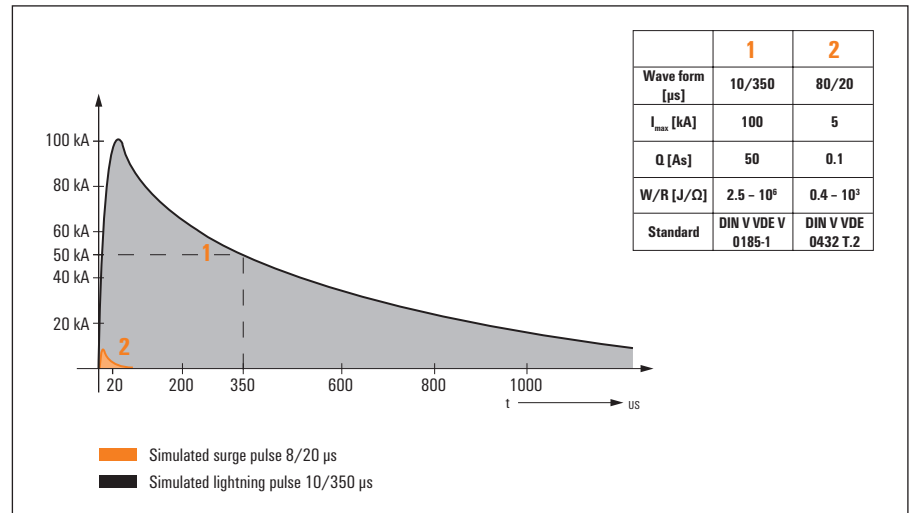

## EMC lightning protection - zone concept in accordance with IEC 62305-4

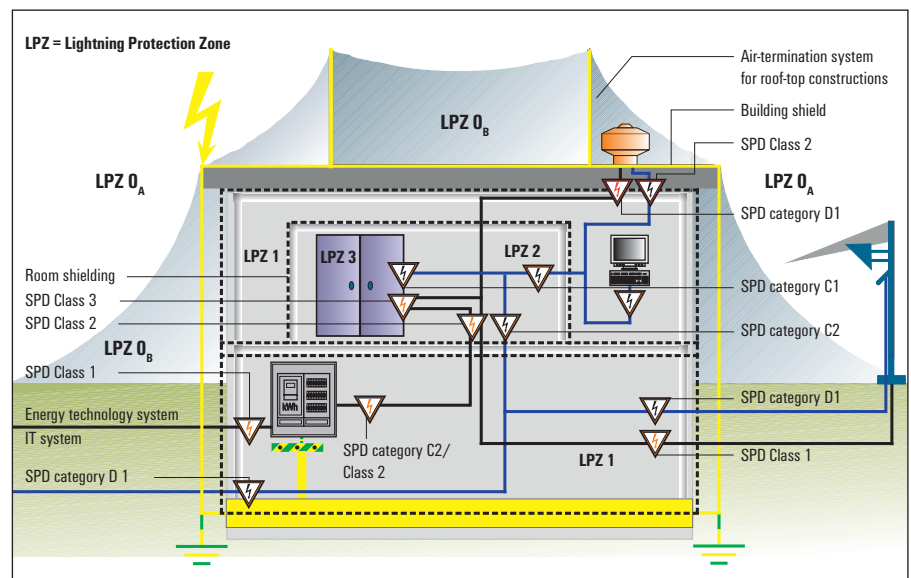

- LPZ 0<sub>A</sub>** Direct impact is possible and full electromagnetic field
- LPZ 0<sub>B</sub>** No direct impact is possible but full electromagnetic field
- LPZ 1** Pulse currents are further limited by current distribution; the lightning field is attenuated by room shielding
- LPZ 2...n** Pulse currents further limited; reduction of the field by room shielding



## **Weidmüller – Your partner in Industrial Connectivity**

As experienced experts we support our customers and partners around the world with products, solutions and services in the industrial environment of power, signal and data. We are at home in their industries and markets and know the technological challenges of tomorrow. We are therefore continuously developing innovative, sustainable and useful solutions for their individual needs. Together we set standards in Industrial Connectivity.

Weidmüller Interface GmbH & Co. KG  
Klingenbergstraße 16  
32758 Detmold, Germany  
T +49 5231 14-0  
F +49 5231 14-292083  
info@weidmueller.com  
www.weidmueller.com

Your local Weidmüller partner can  
be found on our website:  
[www.weidmueller.com/countries](http://www.weidmueller.com/countries)

Made in Germany



Order number: 1366910000/11/2012/SMDM